

*Barbados 2*  
*Art. Nr. 4414502*  
*1/8*

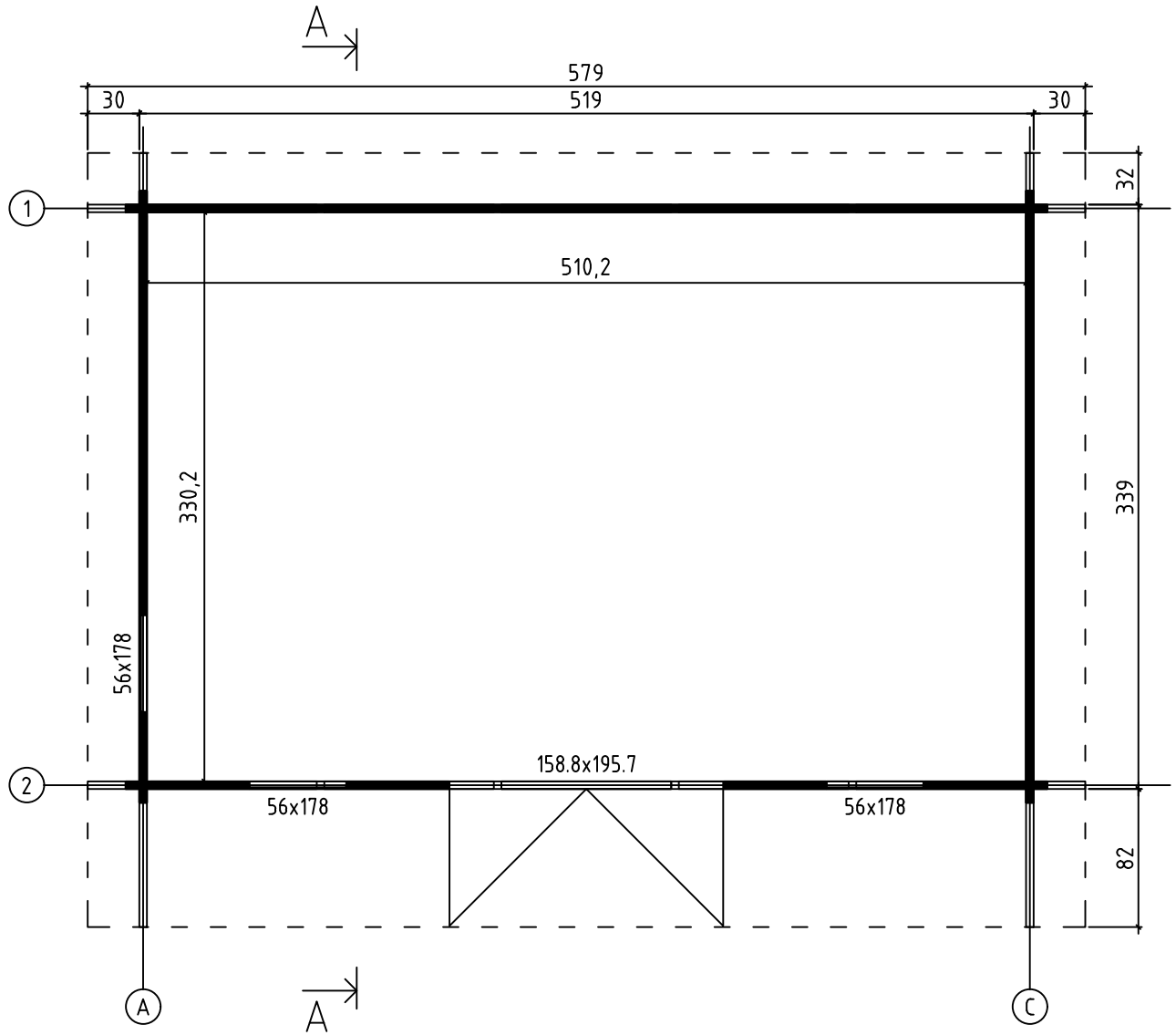

6.09.2016

GROUNDPLAN - GRUNDPLAN - PLAN DE MASSE



FOUNDATION - FUNDAMENT - FONDATION

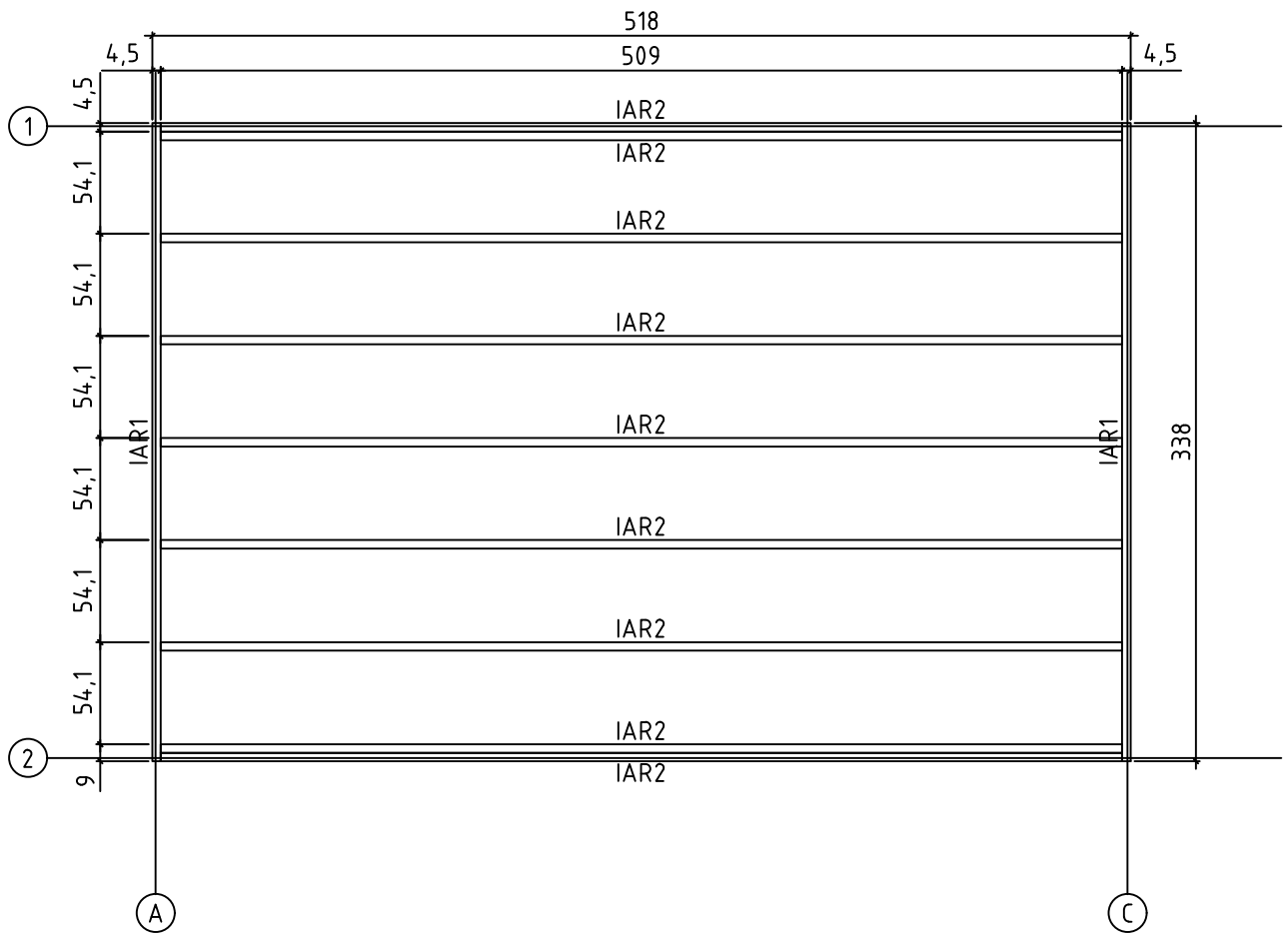



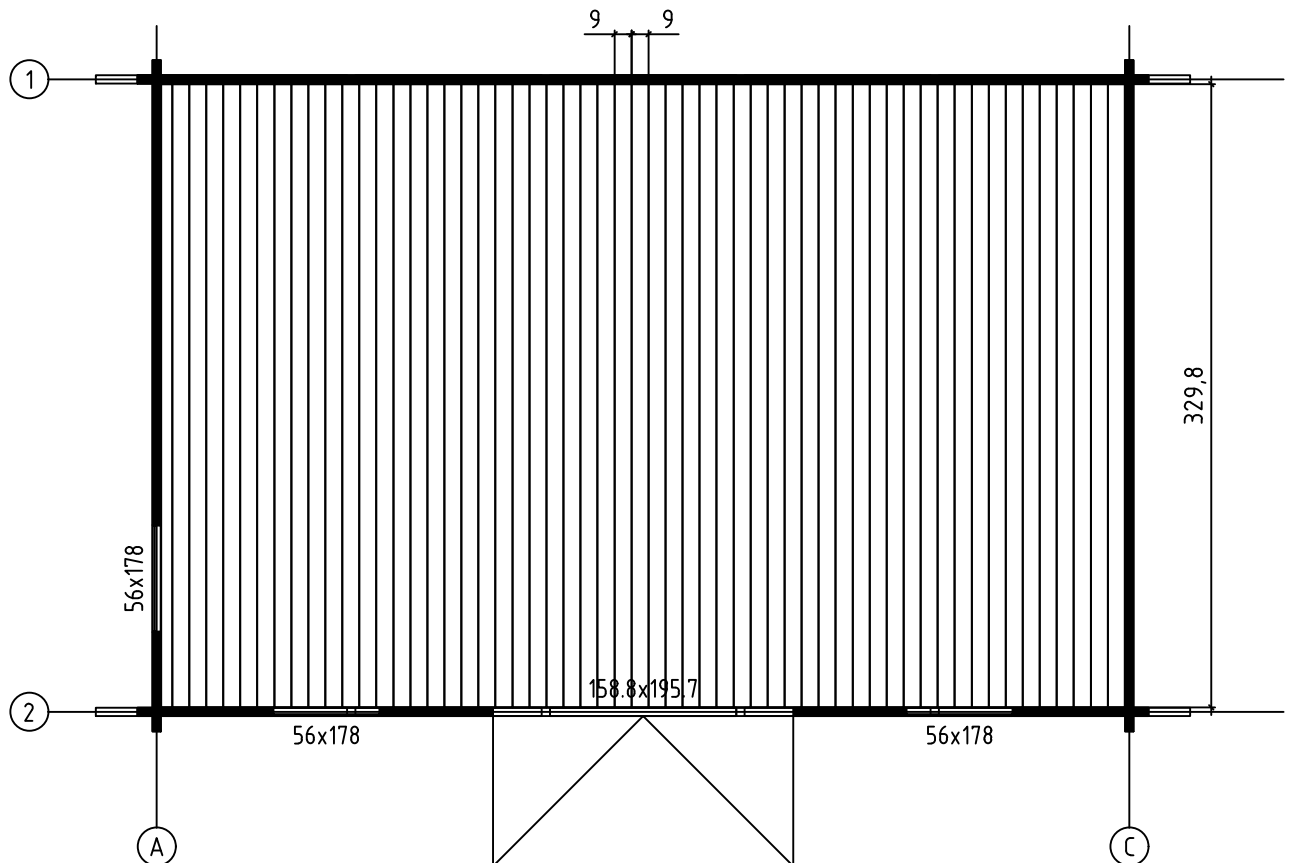

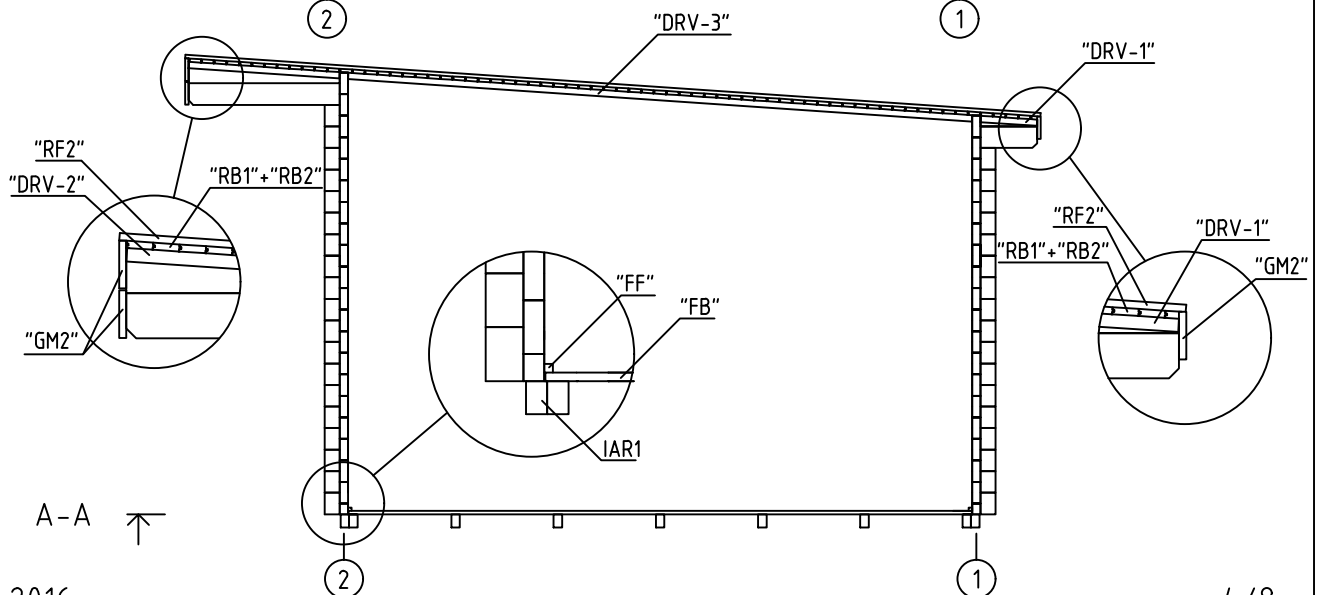
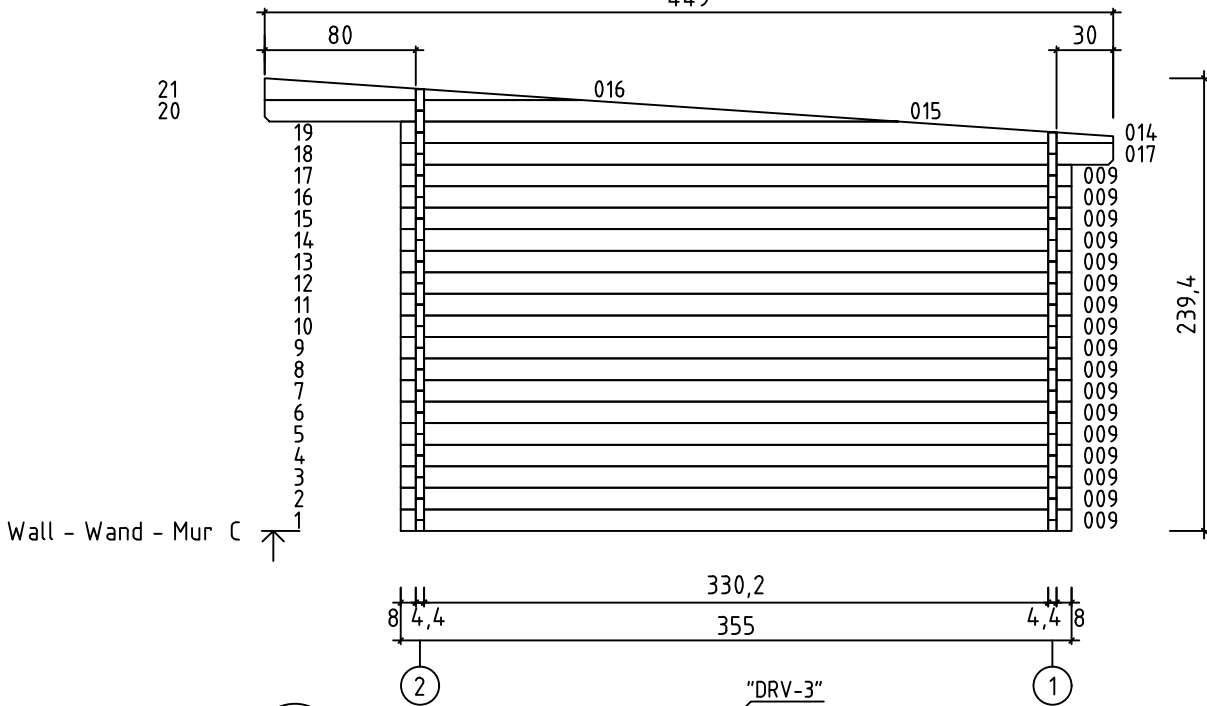
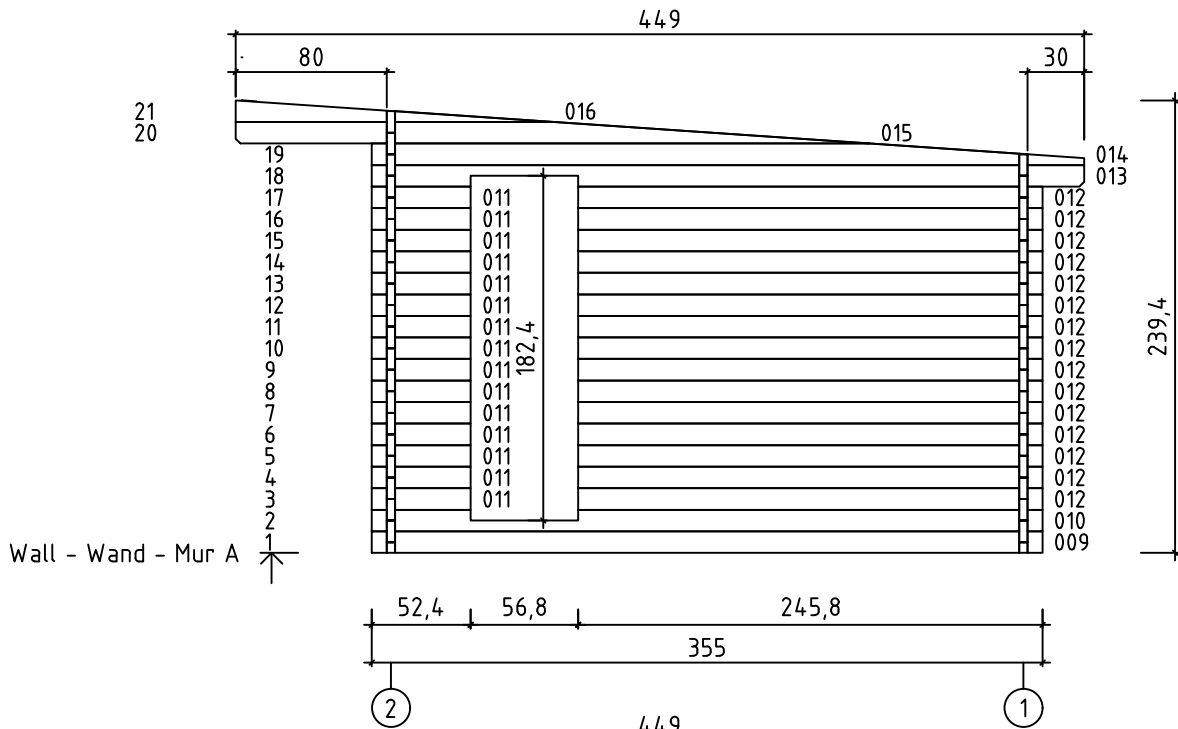

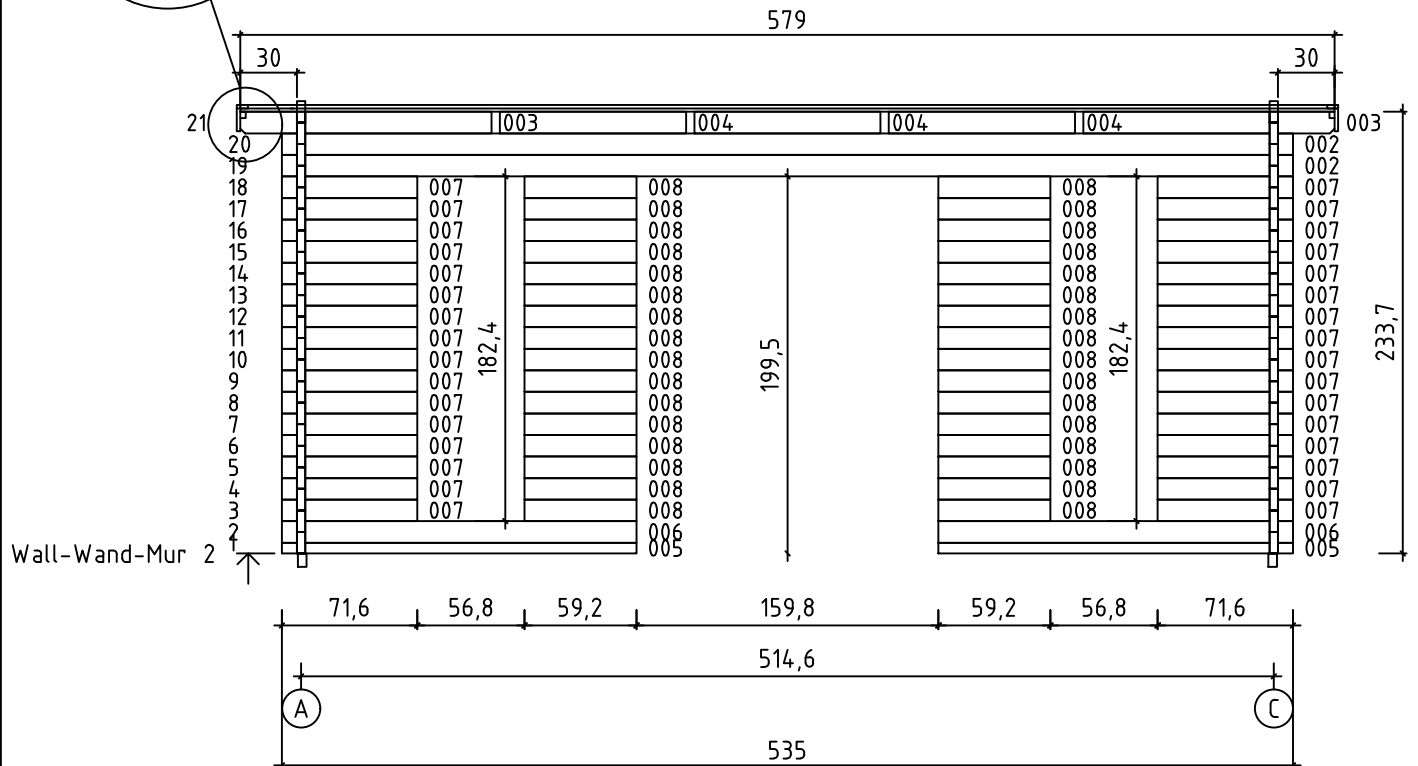
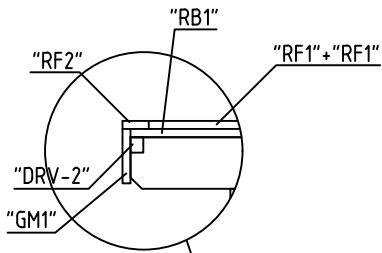
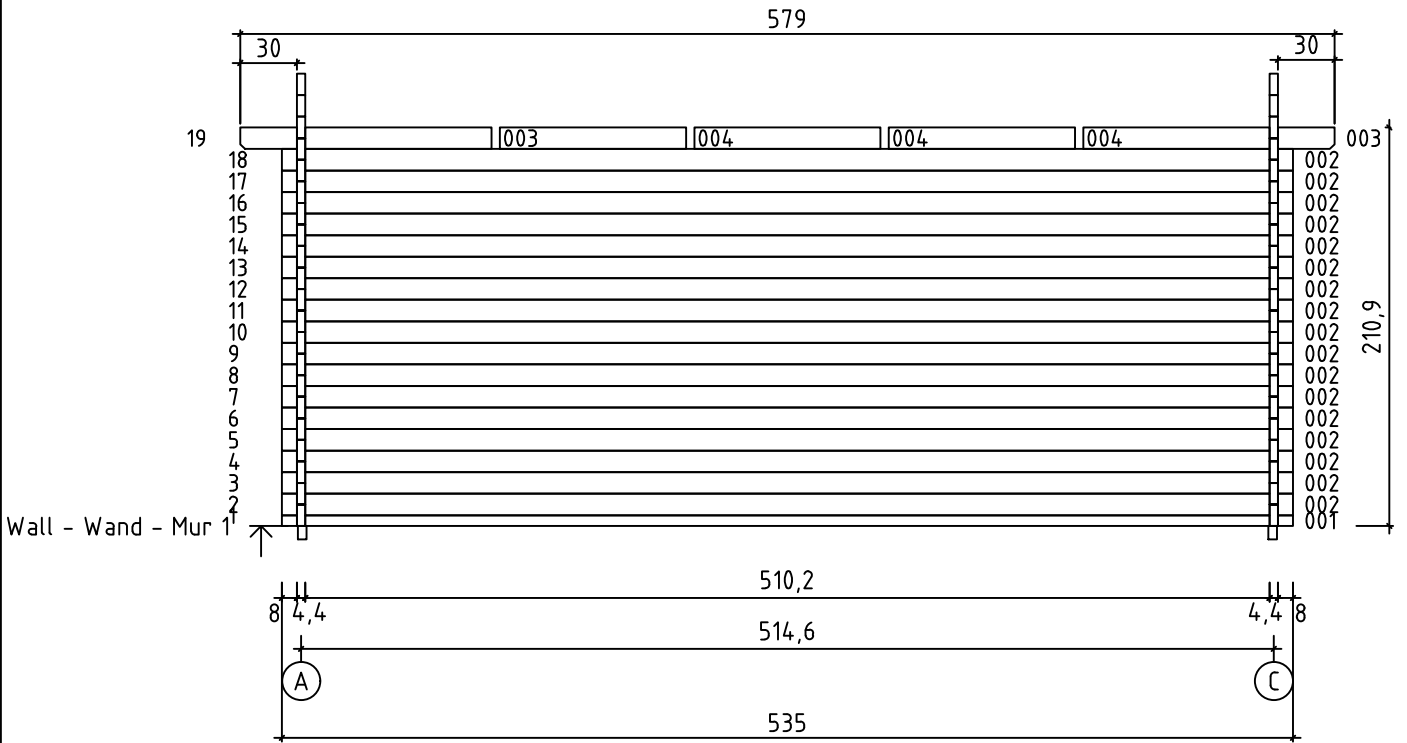

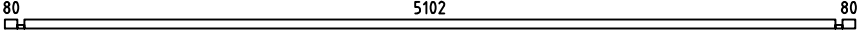
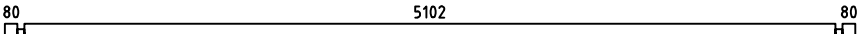
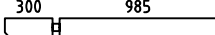
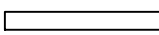
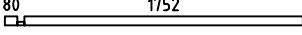
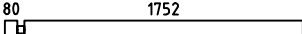
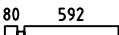

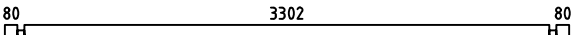
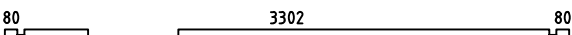

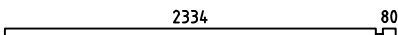
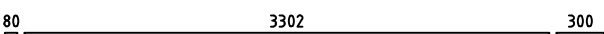
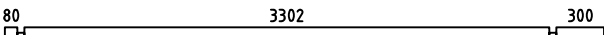
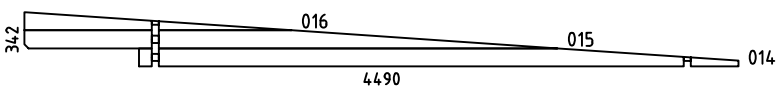



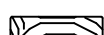
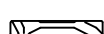



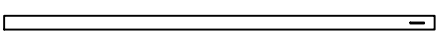
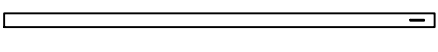
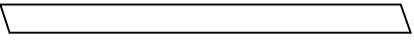
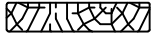

FLOOR BOARDS - FUSSBODENBRETTER - PLAN POSE PLANCHER

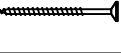

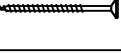
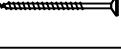

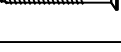
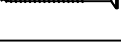



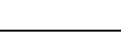
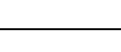
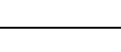
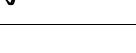

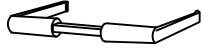

Pos	06.09.2016	Piece list - Stückliste - Liste des pièces Art. Nr. 4414502	6/8	Q	P (mm)	L (mm)
001				1	44x57	5350
002				19	44x114	5350
003				4	44x114	1329
004				6	44x114	985
005				2	44x57	1876
006				2	44x114	1876
007				32	44x114	716
008				32	44x114	592
009				18	44x114	3550
010				1	44x114	3550
011				15	44x114	524
012				15	44x114	2458
013				1	44x114	3770
017				1	44x114	3770
WA-1 WB-1				1 1		
IAR2	FOUNDATION - FUNDAMENT - FONDATION					
IAR1	FOUNDATION - FUNDAMENT - FONDATION					
SR1	RAFTER - DACHSPARREN - CHEVRON					
FB	FLOOR BOARDS - FUSSBODENBRETTER - LAME DE PLANCHER			57	90x18	3298
RB1	ROOF BOARDS - DACHBRETTER - VOLIGES			51	90x18	4439
RB2	ROOF BOARDS - DACHBRETTER - VOLIGES			51	90x18	1351
FF	FLOOR FILLET - FUSSBODENLEISTE - CORNIERE DE FINITION DU PLANCHER				18x18	16.79
RF1	ROOFING FELT FILLET - DACHPAPPENLEISTE - BAGUETTE DE FIXATION DU FEUTRE BITUMEUX			2	18x58	2855
RF2	ROOFING FELT FILLET - DACHPAPPENLEISTE - BAGUETTE DE FIXATION DU FEUTRE BITUMEUX			2	18x58	4536

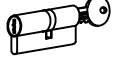
Pos	06.09.2016	Piece list - Stückliste - Liste des pièces Art. Nr. 4414502	7/8	Q	P (mm)	L (mm)
DRV-1	ROOF EDGE REINFORCEMENT - DACHRANDVERSTÄRKUNG - CORNIERE DE RENFORT DE BORD DE TOIT		2	28x34	297	
DRV-2	ROOF EDGE REINFORCEMENT - DACHRANDVERSTÄRKUNG - CORNIERE DE RENFORT DE BORD DE TOIT		2	28x34	800	
DRV-3	ROOF EDGE REINFORCEMENT - DACHRANDVERSTÄRKUNG - CORNIERE DE RENFORT DE BORD DE TOIT		2	28x34	3306	
KFS-1	STORM PROTECTION - STURMLEISTE - LATTE ANTI-TEMPETE		2	22x45	2050	
KFS-2	STORM PROTECTION - STURMLEISTE - LATTE ANTI-TEMPETE		2	22x45	2500	
GM1	GABLE MOULDING - GIBELLEISTE - PLANCHE DE RIVE		2	18x120	4510	
GM2	GABLE MOULDING - GIBELLEISTE - PLANCHE DE RIVE		3	18x120	5826	
FS2	WINDOW HANDLE FITTINGS - FENSTERGRIFF - POIGNEE DE FENETRE		3			
HS9	SCREW FOR GABLE MOULDING - SCHRAUBEN FÜR GIBELLEISTE - VIS POUR FIXATION PLANCHE DE RIVE		66	3.5x50		
HS4	SCREW FOR DOOR FILLET - SCHRAUBE ZUR BEFESTIGUNG TÜRLEISTE - VIS POUR FIXATION BAGUETTE D'ARRET DE PORTE		5	3x30		
HS12	SCREW FOR ROOF EDGE REINFORCEMENT - SCHRAUBEN FÜR DACHRANDVERSTÄRKUNG - VIS POUR FIXATION CORNIERE RENFORT DE BORD DE TOIT		24	4x40		
HS18	SCREW FOR ROOF BEAMS - SCHRAUBEN FÜR DACHBALKEN - VIS POUR FIXATION PANNES DE TOIT		12	5x120		
HS18	SCREW FOR GABLE - SCHRAUBEN FÜR GIEBEL - VIS POUR FIXATION DES PIGNONS		8	5x120		
HS16	SCREW FOR 1. WALL BEAM - SCHRAUBE FÜR 1. BOHLENREIHE - VIS DE FIXATIONS 1ere RANGÉE DE MADRIERS AVEC POUTRELLES DE FONDATIONS		8	5x90		
HS16	SCREW FOR FOUNDATION - SCHRAUBEN ZUR BEFESTIGUNG FUNDAMENT - VIS DE FIXATIONS DES POUTRELLES DE FONDATIONS		26	5x90		
HS16	SCREW FOR DOOR JAMB - SCHRAUBE FÜR TÜRRAHMEN - VIS DE FIXATION PARTIE HAUTE AVEC MONTANTS DU CADRE DE PORTE		4	5x90		
HS23	SCREW FOR POS. 003, 004 - SCHRAUBEN FÜR POS. 003, 004 - VIS POUR FIXATION DERNIÈRE RANGÉE MADRIERS (MURS AVANT ET ARRIÈRE)		10	6x180		
HS25	SCREW FOR DOORSTEP - SCHRAUBEN FÜR SWELLE - VIS POUR FIXATION BARRE DE SEUIL		3	4.5x65		
NF2	ZN NAIL FOR FLOOR FILLET - ZN NÄGEL FÜR FUSSBODENLEISTE - POINTE POUR CORNIERE DE FINITION DU PLANCHER		34	1.4x40		
SH44	HAMMER BLOCK - SCHLAGHOLZ - CALLE DE FRAPPE		1			
SFS	NUT FOR STORM PROTECTION - SCHRAUBENMUTTER FÜR STURMLEISTE - ECROU POUR LATTE ANTI-TEMPETE		8	D8		
NF4	ZN NAIL FOR ROOF - ZN NÄGEL FÜR DACHBRETTER - POINTE POUR FIXATION VOLIGES DE TOIT		374	2x50		
NF4	ZN NAIL FOR FLOOR - ZN NÄGEL FÜR FUSSBODENBRETTER - CLOUS POUR PLANCHER		406	2x50		
NF5	ZN NAIL FOR ROOFING FELT FILLET - ZN NÄGEL FÜR DACHPAPPENLEISTE - POINTE POUR BAGUETTE DE FIXATION FEUTRE BITUMEUX		34	2x40		
BFS	BOLT FOR STORM PROTECTION - BOLZEN FÜR STURMLEISTE - BOULON POUR LATTE ANTI-TEMPETE		8	8x80		

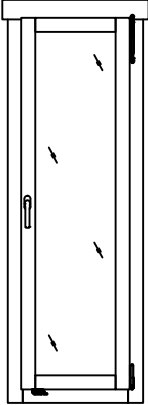
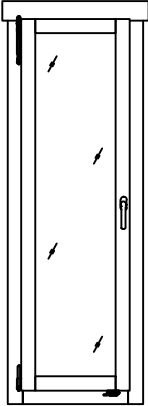
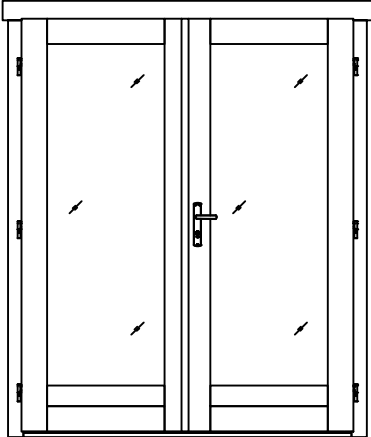
Pos	06.09.2016	Piece list - Stückliste - Liste des pièces Art. Nr. 4414502	8/8	Q	P (mm)	L (mm)
		MALE BOLT HINGE FOR DOOR - TÜRRIEGEL - PARTIE MALE DE PAUMELLE DE PORTE		6	14/80	
DFS		WASHER FOR STORM PROTECTION - DICHTSCHEIBE FÜR STURMLEISTE - RONDELLE POUR LATTE ANTI-TEMPETE		8	D8	
TL4		DOOR HANDLE FITTINGS - TÜRGRIF - POIGNEE DE PORTE		1		
TL5		SET OF DOOR LOCK COVERS - SCHLOSSBLENDEN - SET DE GARNITURES DE PORTE		1		
		CYLINDER LOCK - ZYLINDERSCHLOSS - BARILLET DE PORTE		1	30/35	
		STRIKER FOR BARREL BOLT - HÜLSE FÜR GRENDRIEGEL - GACHE AU SOL DU TARGETTE		2		
		WINDOW - FENSTER - FENETRE 560x1780 DGP+ 	AK.1.100.PSP	2		
		WINDOW - FENSTER - FENETRE 560x1780 DGP+ 	AK.1.100.PSV	1		
		DOOR - TÜR - PORTE 1588x1957 DGP+ 	TUK.1.100.PVP.MM	1		