

Baruda 53
Art.Nr. 407999
1/8

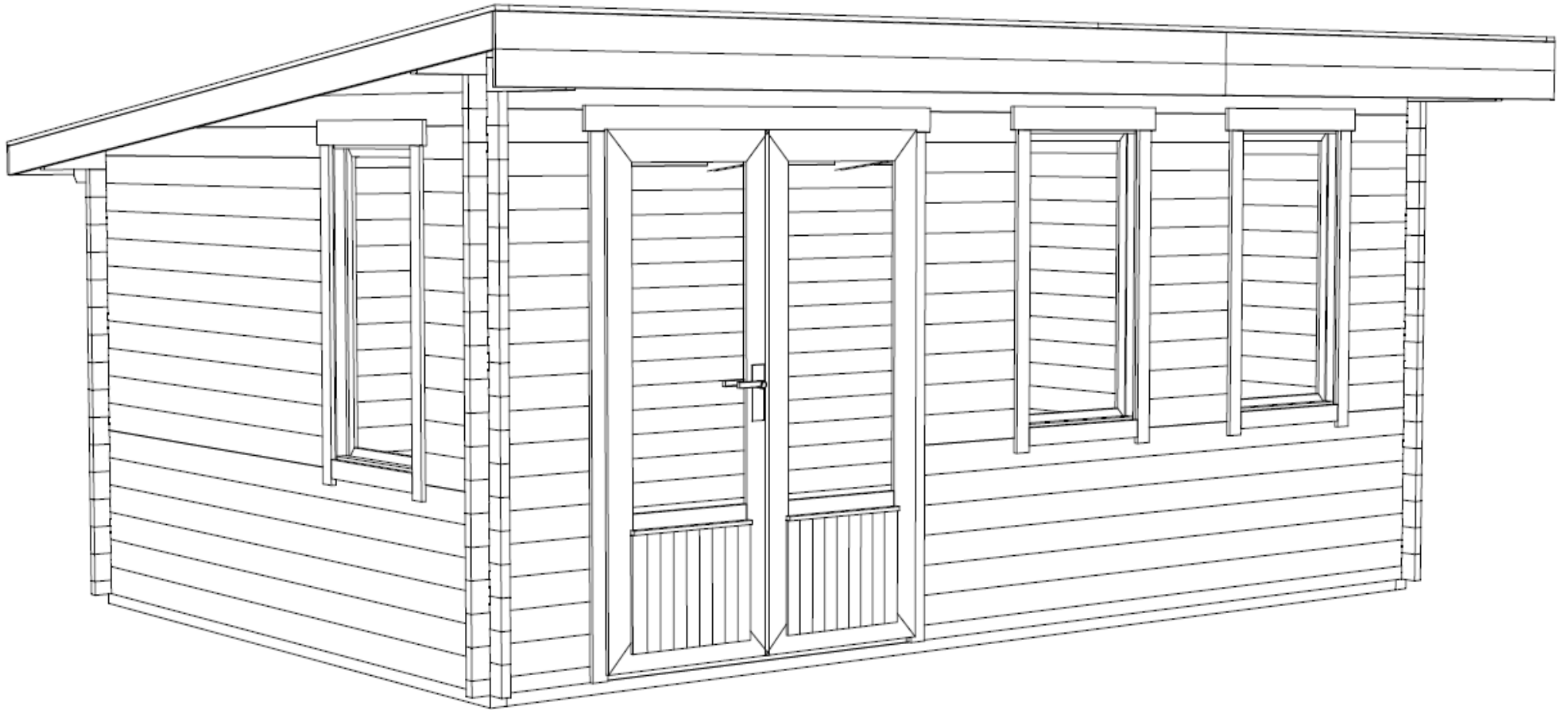

40x114
28.05.2013

GROUNDPLAN - GRUNDPLAN - PLAN DE MASSE

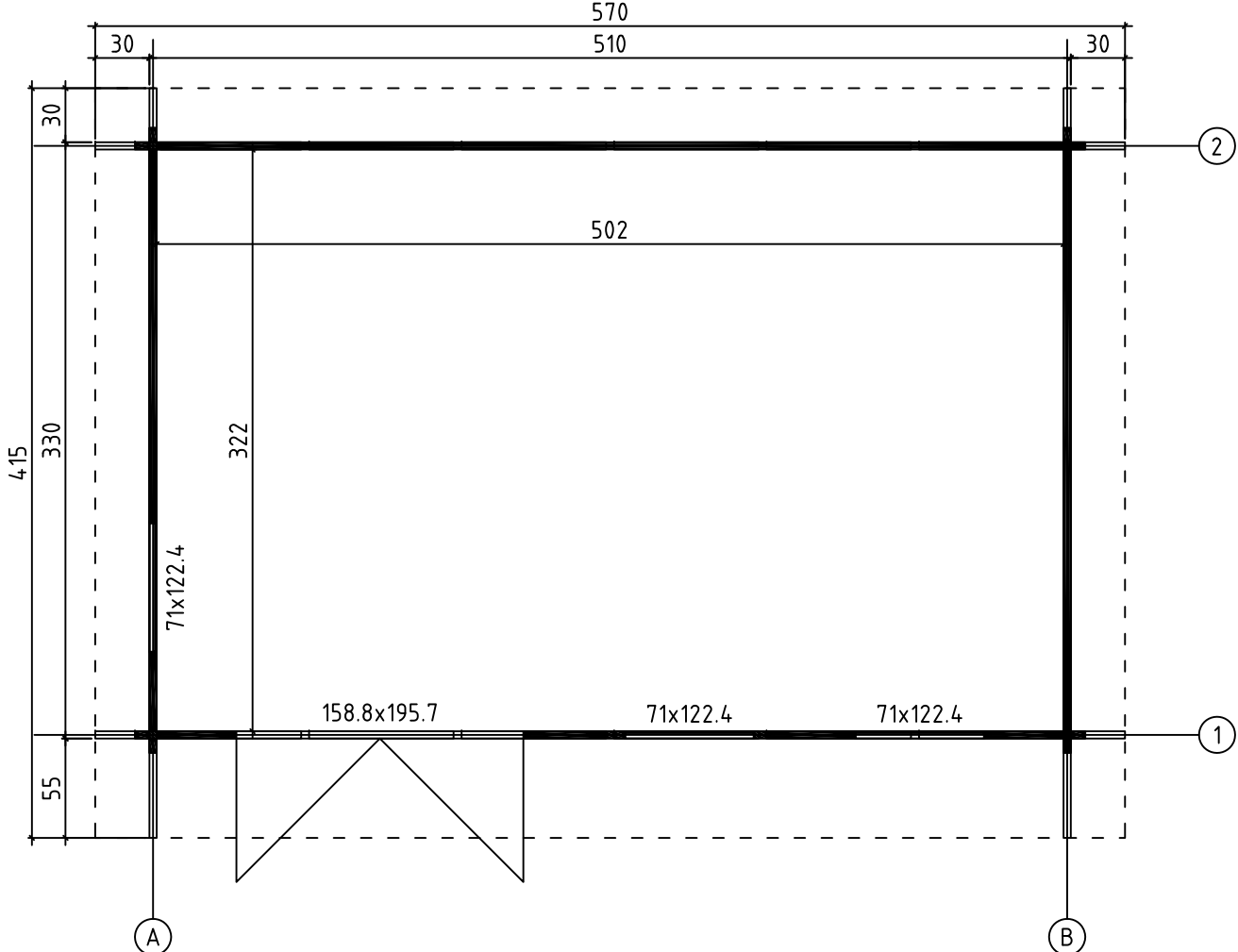

FOUNDATION - FUNDAMENT - FONDATION

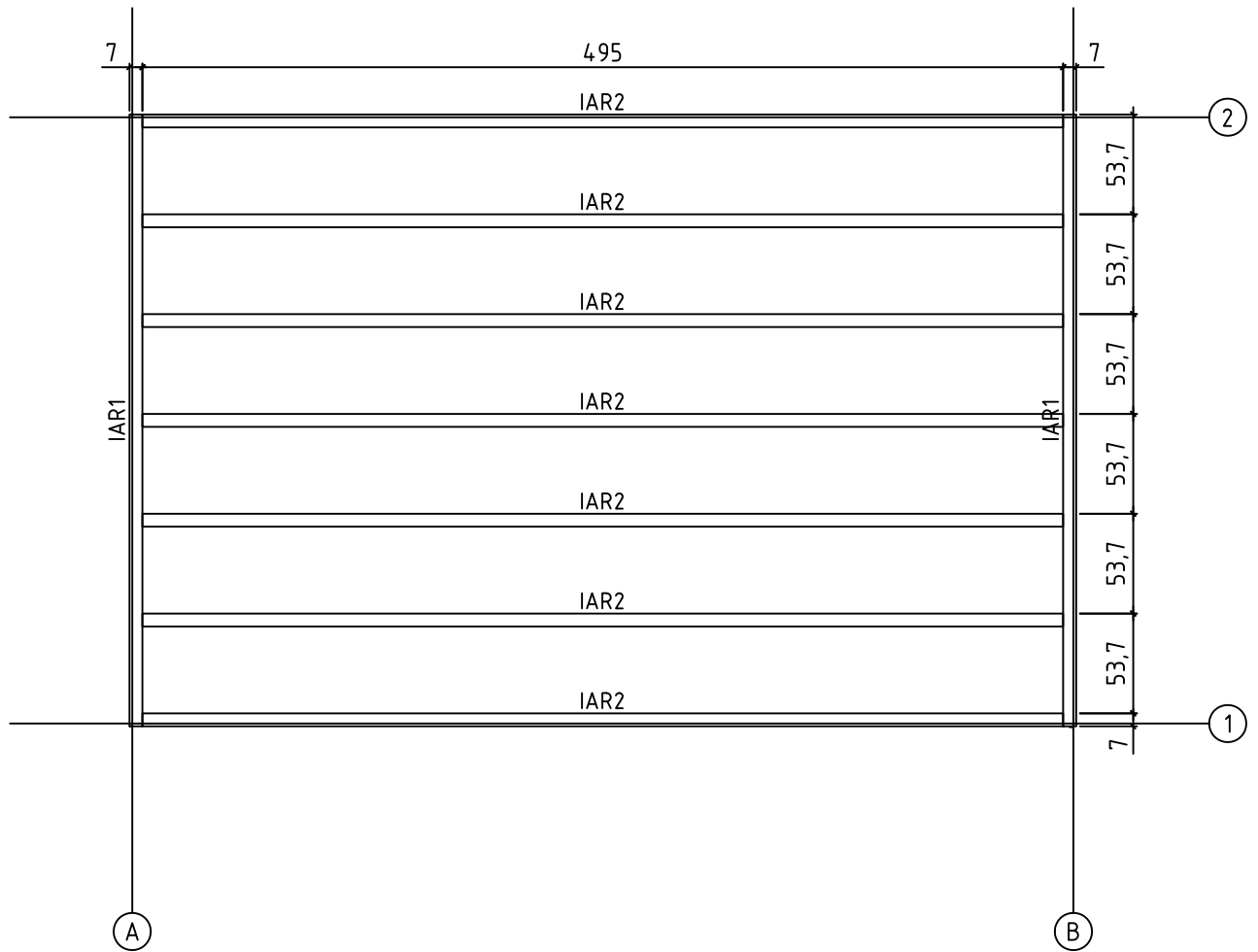

FLOOR BOARDS - FUSSBODENBRETTER - LAME DE PLANCHER

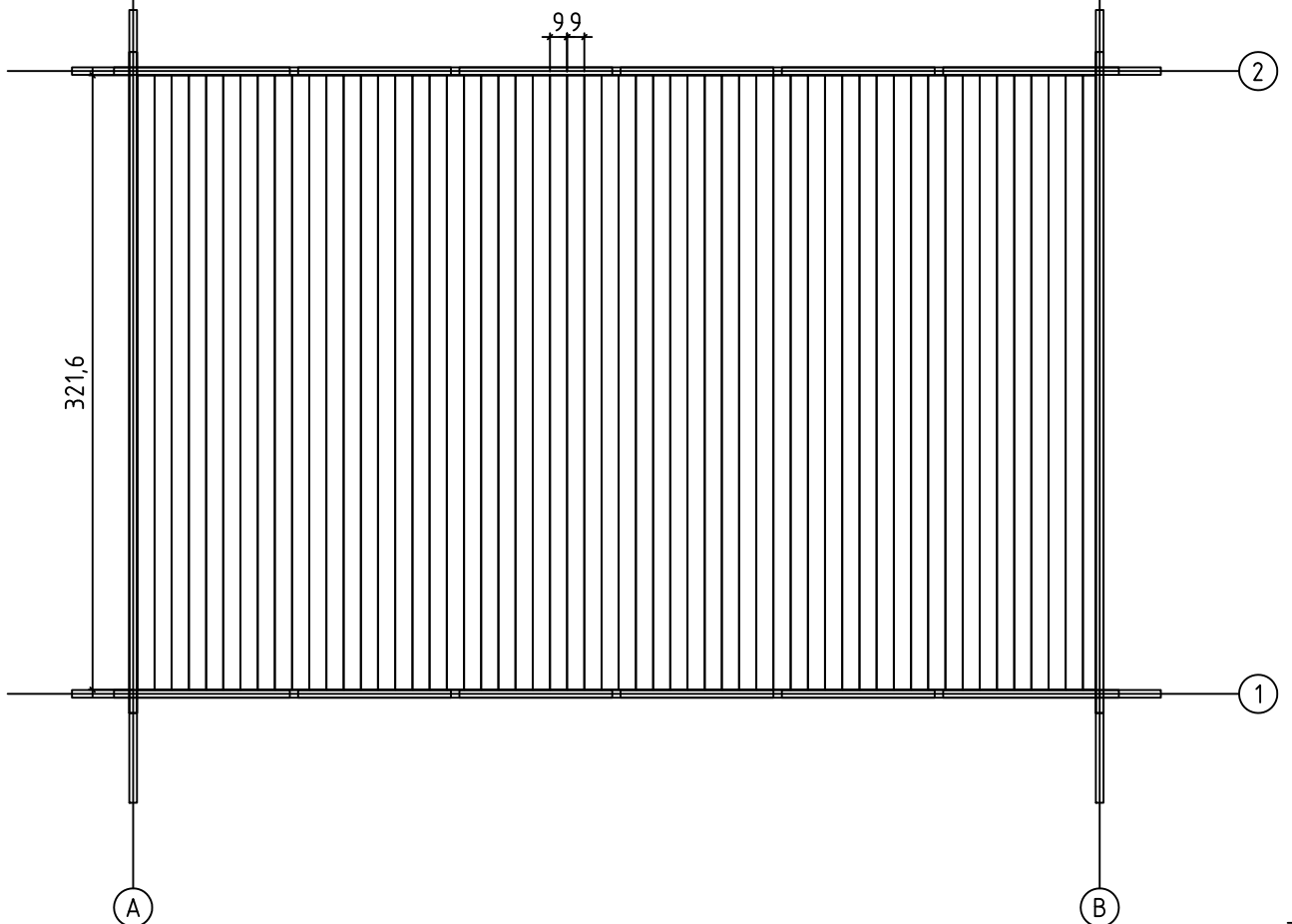

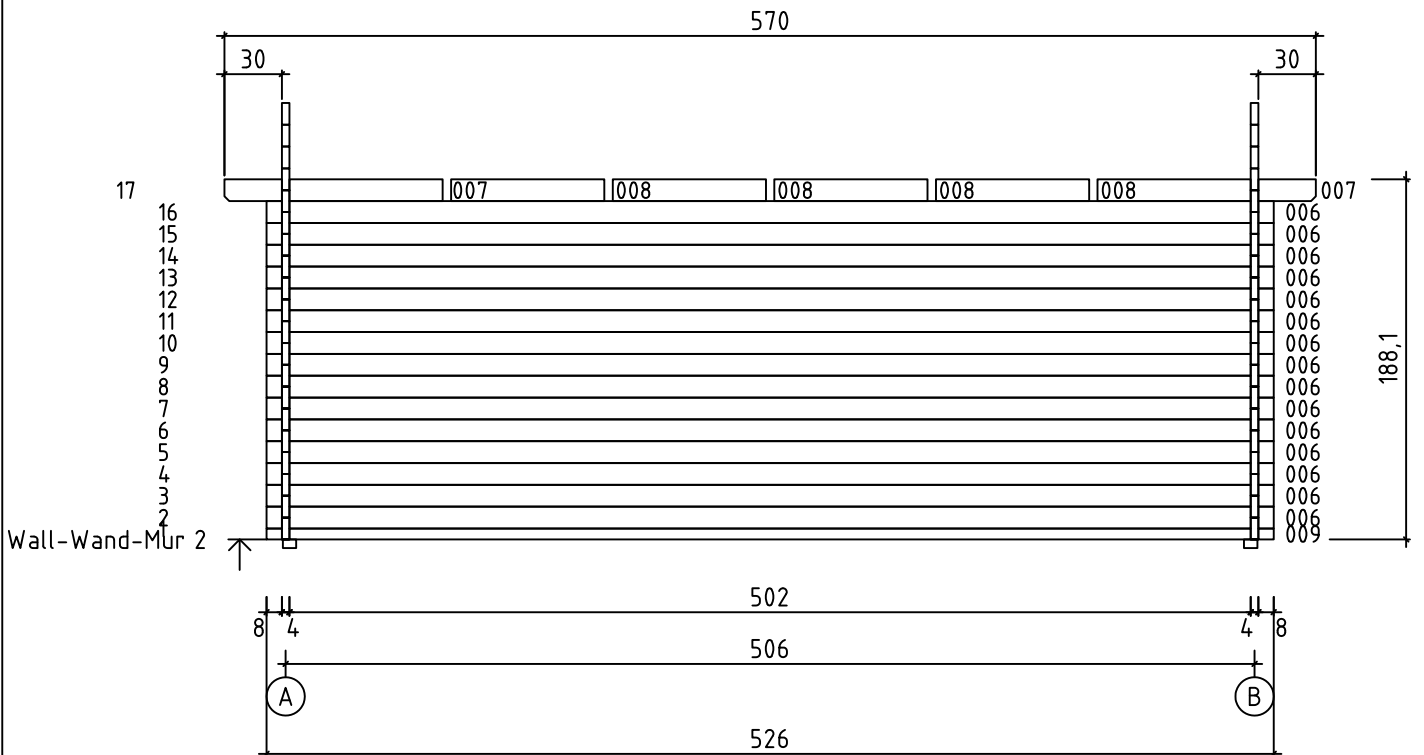
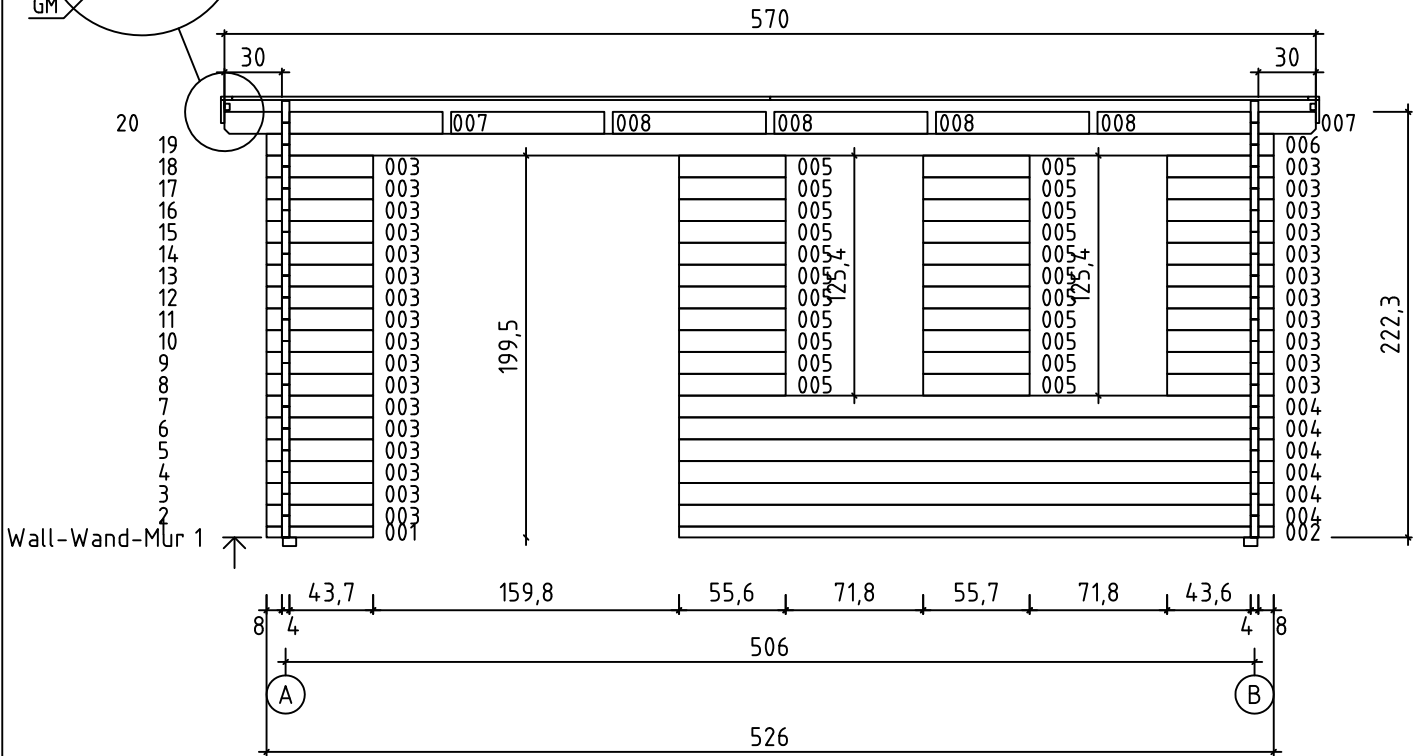
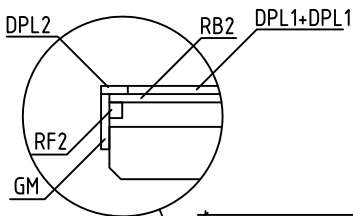

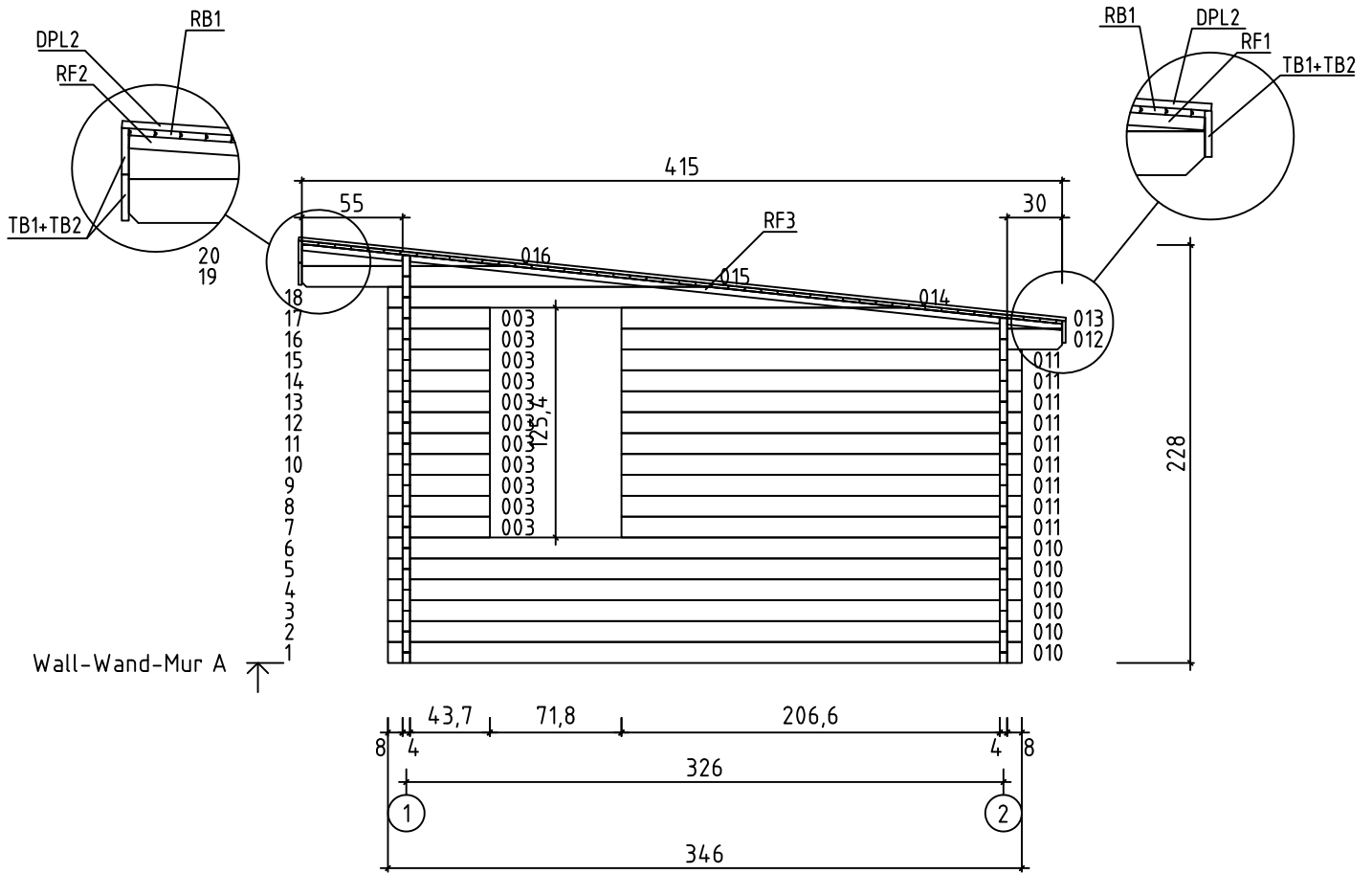



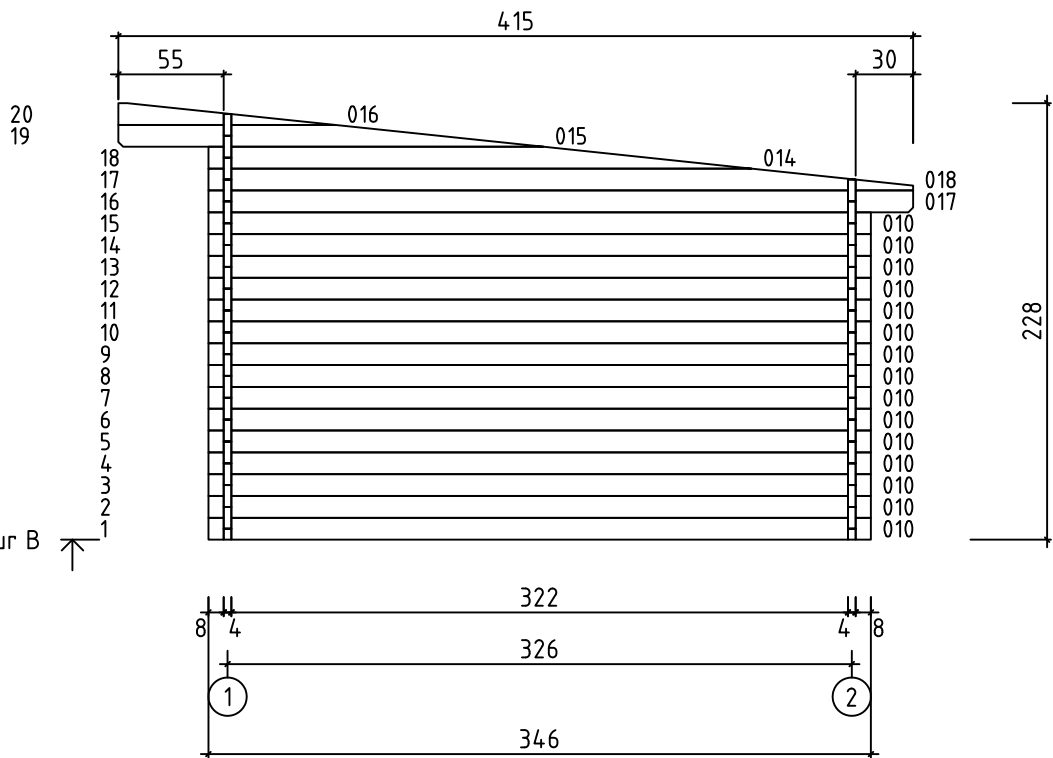



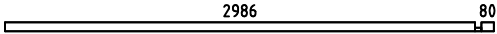

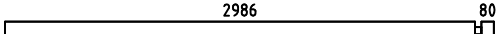

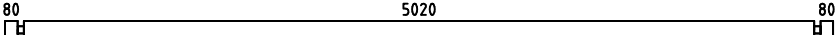
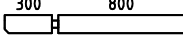
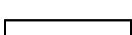
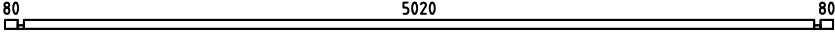
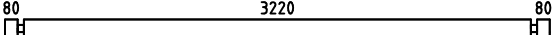
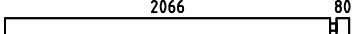
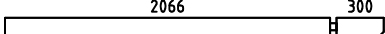
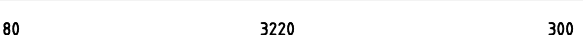
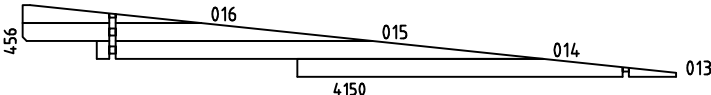
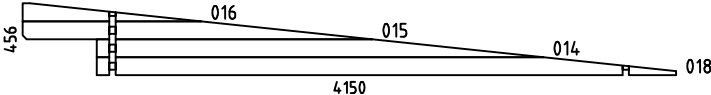







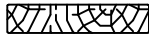
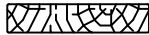



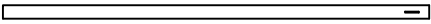
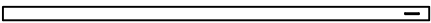
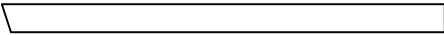

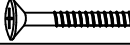

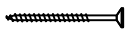
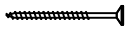
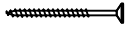

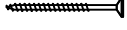

Wall-Wand-Mur A

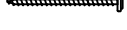
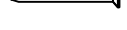
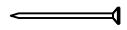

Wall-Wand-Mur B

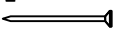
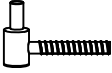
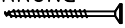
Pos	6/8	Piece list - Stückliste - Liste des pièces Art.Nr. 407999	28.05.2013	Q.	P (mm)	L (mm)
001				1	40x57	557
002				1	40x57	3106
003				39	40x114	557
004				6	40x114	3106
005				22	40x114	557
006				16	40x114	5260
007				4	40x114	1140
008				8	40x114	800
009				1	40x57	5260
010				21	40x114	3460
011				9	40x114	2186
012				1	40x114	2406
017				1	40x114	3680
WA-1				1		
WB-1				1		
IAR2	FOUNDATION - FUNDAMENT - FONDATION			7	70x45	4950
IAR1	FOUNDATION - FUNDAMENT - FONDATION			2	70x45	3290
SR1	RAFTER - DACHSPARREN - CHEVRON			5	44x140	4187
	FLOOR BOARDS - FUSSBODENBRETTER - LAME DE PLANCHER			56	90x18	3216
RB1	ROOF BOARDS - DACHBRETTER - VOLIGES			94	90x18	2850
	FLOOR FILLET-FUSSBODENLEISTE - CORNIERE DE FINITION DU PLANCHER				18x18	16.46
DPL1	ROOFING FELT FILLET - DACHPAPPENLEISTE - BAGUETTE DE FIXATION DU FEUTRE BITUMEUX			2	18x58	2810
DPL2	ROOFING FELT FILLET - DACHPAPPENLEISTE - BAGUETTE DE FIXATION DU FEUTRE BITUMEUX			2	18x58	4210

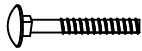
Pos	7/8	Piece list - Stückliste - Liste des pièces Art.Nr. 407999	28.05.2013	Q.	P (mm)	L (mm)
TB1	EAVES BOARD - TRAUFBRETT - BANDEAU DE TOIT		3	18x120	2138	
TB2	EAVES BOARD - TRAUFBRETT - BANDEAU DE TOIT		3	18x120	3598	
RF1	ROOF EDGE REINFORCEMENT - DACHRANDVERSTÄRKUNG - CORNIERE DE RENFORT DE BORD DE TOIT		2	28x34	298	
RF2	ROOF EDGE REINFORCEMENT - DACHRANDVERSTÄRKUNG - CORNIERE DE RENFORT DE BORD DE TOIT		2	28x34	549	
RF3	ROOF EDGE REINFORCEMENT - DACHRANDVERSTÄRKUNG - CORNIERE DE RENFORT DE BORD DE TOIT		2	28x34	3233	
	STORM PROTECTION - STURMLEISTE - LATTE ANTI-TEMPETE		2	22x45	1800	
	STORM PROTECTION - STURMLEISTE - LATTE ANTI-TEMPETE		2	22x45	2100	
GL	GABLE MOULDING - GIEBELLEISTE - PLANCHE DE RIVE		2	18x120	4185	
	WINDOW HANDLE FITTINGS-FENSTERGRIFF - POIGNÉE D'OUVERTURE DE FENETRE		6			
	BOLT FOR WINDOW HANDLE FITTINGS - BOLZEN FÜR FENSTERGRIFF BESCHLAG BOULON POUR POIGNÉE D'OUVERTURE DE FENETRE		12			
	SCREW FOR ROOF BEAMS - SCHRAUBEN FÜR DACHBALKEN - VIS POUR PANNE DE TOIT		16	5x120		
	SCREW FOR 1. WALL BEAM - SCHRAUBE FÜR 1. BOHLENREIHE - VIS DE FIXATION DES FONDATIONS		10	5x90		
	SCREW FOR DOOR JAMB - SCHRAUBE FÜR TÜRRAHMEN - VIS DE FIXATION POUR MONTANT DE PORTE		4	5x90		
	SCREW FOR GABLE MOULDING - SCHRAUBEN FÜR GIEBELLEISTE - VIS DE FIXATION POUR PLANCHE DE RIVE		8	3.5x50		
	SCREW FOR DOOR FILLET - SCHRAUBE ZUR BEFESTIGUNG TÜRLEISTE - VIS D'ASSEMBLAGE DU CADRE DE PORTE		5	3x30		
	SCREW FOR EAVES BOARDS - SCHRAUBEN FÜR TRAUFBRETT - VIS DE FIXATION POUR BANDEAU DE TOIT		54	4x40		
	SCREW FOR FUNDAMENT - SCHRAUBEN ZUR BEFESTIGUNG FUNDAMENT - VIS POUR FONDATION		14	5x120		
	SCREW FOR GABLE - SCHRAUBEN FÜR GIEBEL - VIS POUR FIXATION DES PIGNONS		16	5x120		
	SCREWS FOR DET. 007, 008 - SCHRAUBEN FÜR Det. 006, 007, 008 - VIS DE FIXATION DET. 007, 008		24	6x180		
	ZN NAIL FOR FLOOR FILLET - ZN NÄGEL FÜR FUSSBODENLEISTE - POINTE POUR CORNIERE DE FINITION DU PLANCHER		34	1.4x40		
	DOOR HANDLE FITTINGS-TÜRGRIFF - SET DE GARNITURES DE SERRURE DE PORTE		1			
	HAMMER BLOCK - SCHLAGHOLZ - CALLE DE FRAPPE		1			
	SCREW FOR DOORSTEP - SCHRAUBEN FÜR SWELLE - VIS DE FIXATION DU SEUIL DE PORTE		5	4.5x65		
	ZN NAIL FOR ROOF - ZN NÄGEL FÜR DACHBRETT - POINTE POUR TOIT		396	2x50		
	ZN NAIL FOR FLOOR - ZN NÄGEL FÜR FUSSBODENBRETT - CLOUS POUR PLANCHER		406	2x50		

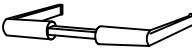
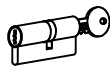
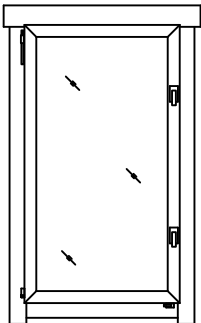
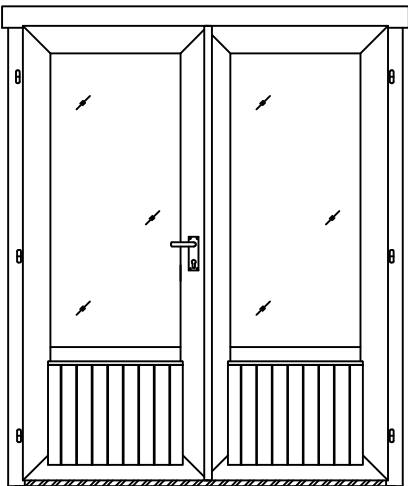
Pos	8/8	Piece list - Stückliste - Liste des pièces Art.Nr. 407999	28.05.2013	Q.	P (mm)	L (mm)
		ZN NAIL FOR ROOFING FELT FILLET - ZN NÄGEL FÜR DACHPAPPENLEISTE - POINTE POUR BAGUETTE FIXATION FEUTRE BITUMEUX		32	2x40	
		MALE BOLT HINGE FOR DOOR - TÜRRIEGEL - PARTIE MALE DE CHARNIERE DE PORTE		6		
		SCREW FOR ROOF EDGE REINFORCEMENT - SCHRAUBEN FÜR DACHRANDVERSTÄRKUNG - VIS POUR RENFORT DE BORD DE TOIT		22	4x40	
		NUT FOR STORM PROTECTION - SCHRAUBENMUTTER FÜR STURMLEISTE - ÉCROU POUR LAME ANTI-TEMPETE		8		
		BOLT FOR STORM PROTECTION - BOLZEN FÜR STURMLEISTE - VIS POUR LAME ANTI-TEMPETE		8		
		WASHER FOR STORM PROTECTION - DICHTSCHEIBE FÜR STURMLEISTE - RONDELLE POUR LAME ANTI-TEMPETE		8		
		DOOR HANDLE FITTINGS-TÜRGRIFF - SET DE GARNITURES DE SERRURE DE PORTE		1		
		CYLINDER LOCK -ZYLINDERSCHLOSS - CYLINDRE DE SERRURE		1		
		WINDOW - FENSTER - FENETRE AK.1.00.PSV.e 710x1224		3		
		DOOR - TÜR - PORTE TUK.2.060.PVV.MMW 1588x1957		1		