

Orkney
Art. Nr. 4413802
1/10

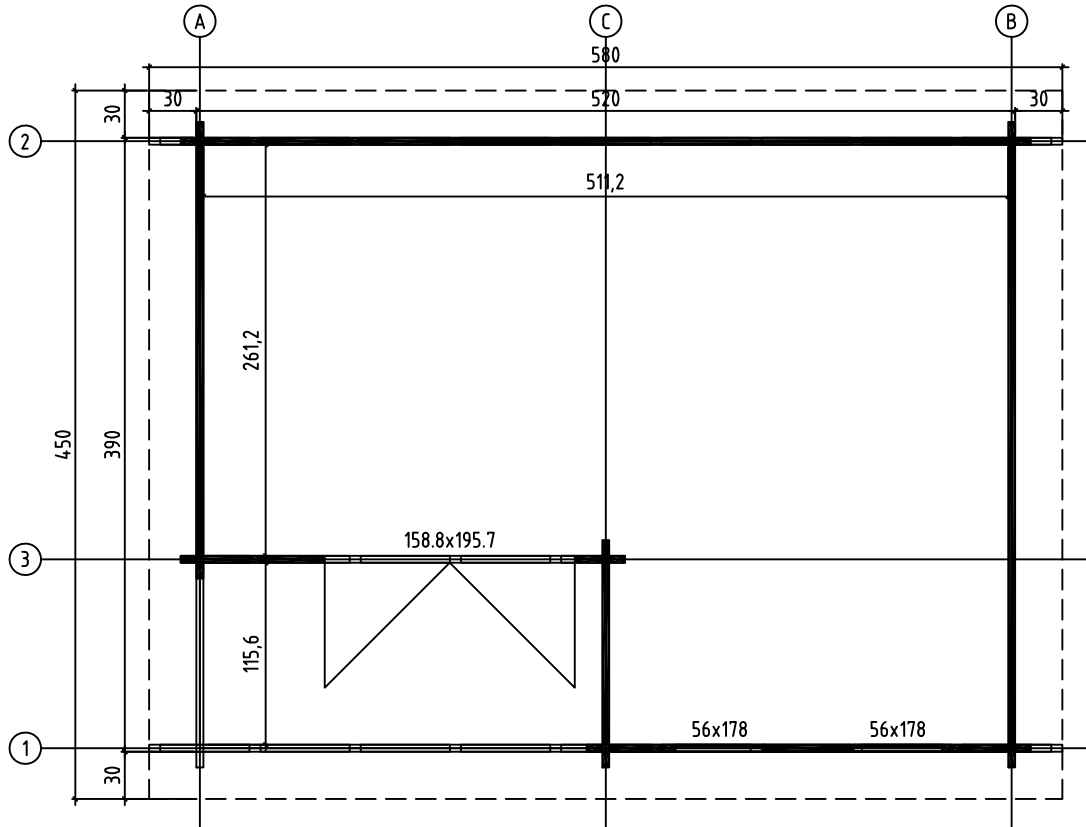

19.11.2015

Art.Nr. 4413802
 GRUNDPLAN - GRUNDPLAN - PLAN DE MASSE



FOUNDATION - FUNDAMENT - FONDATION

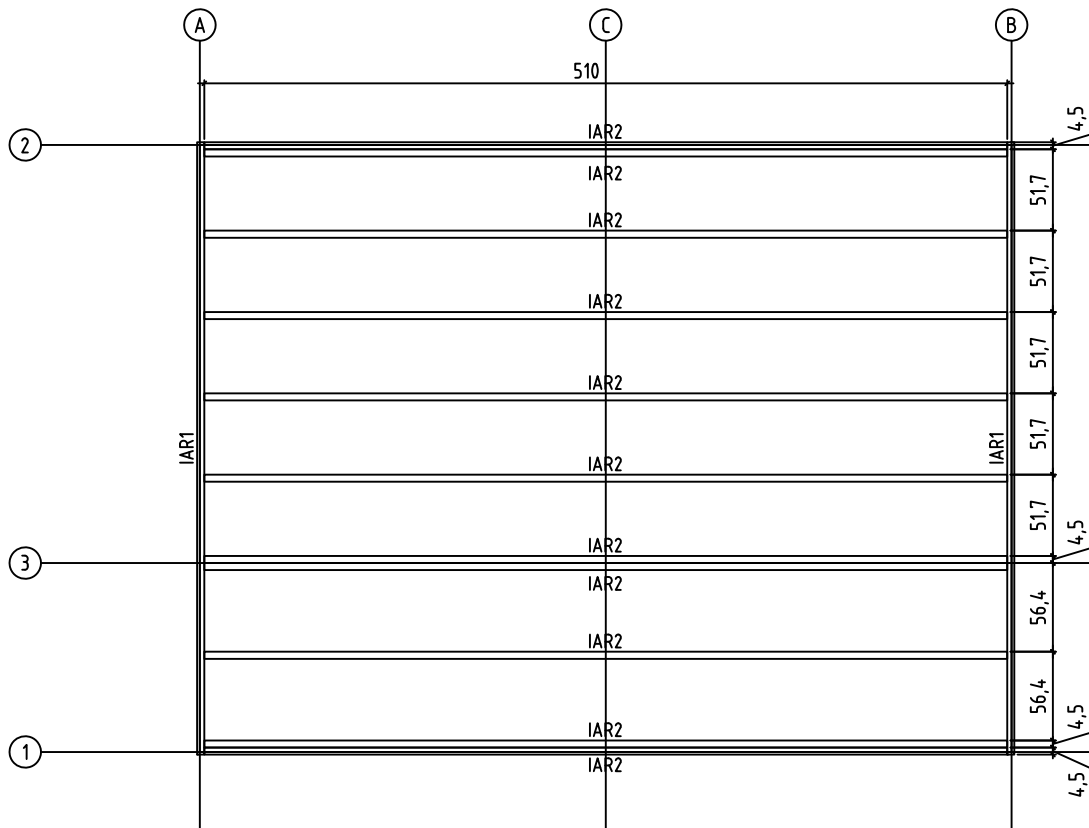

FLOOR BOARDS - FUSSBODENBRETTER - LAME DE PLANCHER
 TERRACE BOARDS - TERRASSENBRETTER - PLANCHER DE TERRASSE

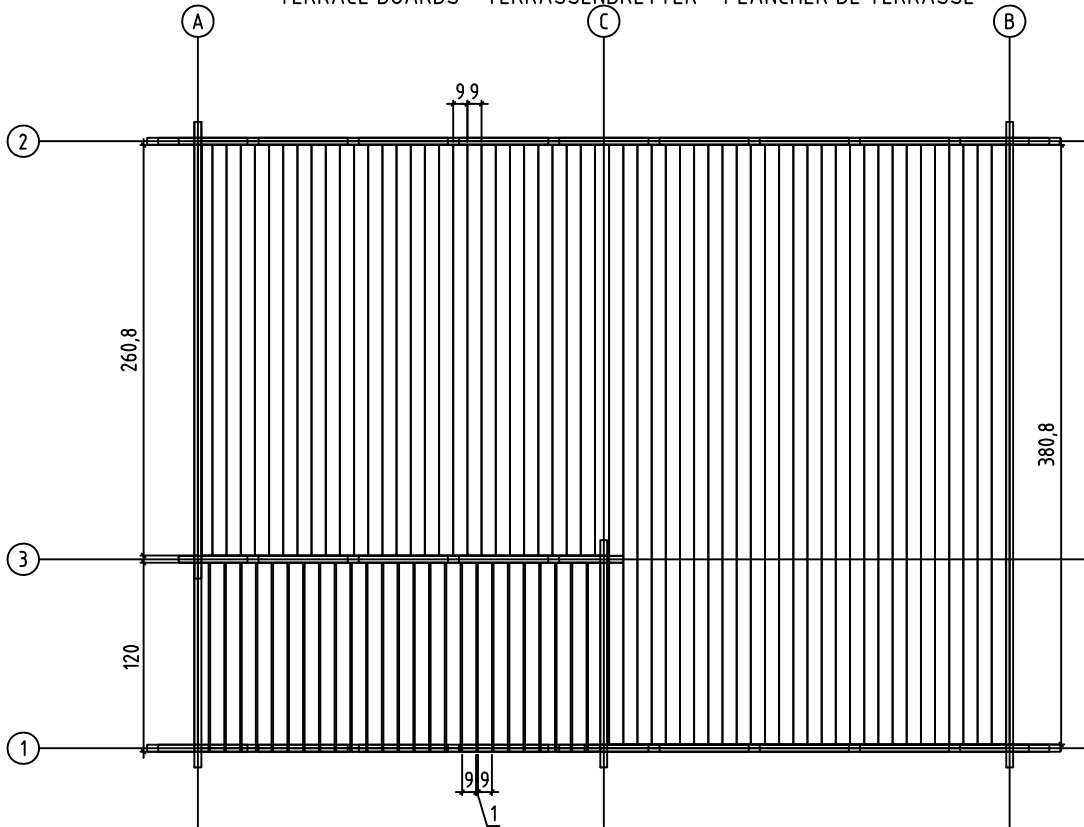

RAFTERS PLAN - DACHSPARREN - PLAN DE CHEVRON

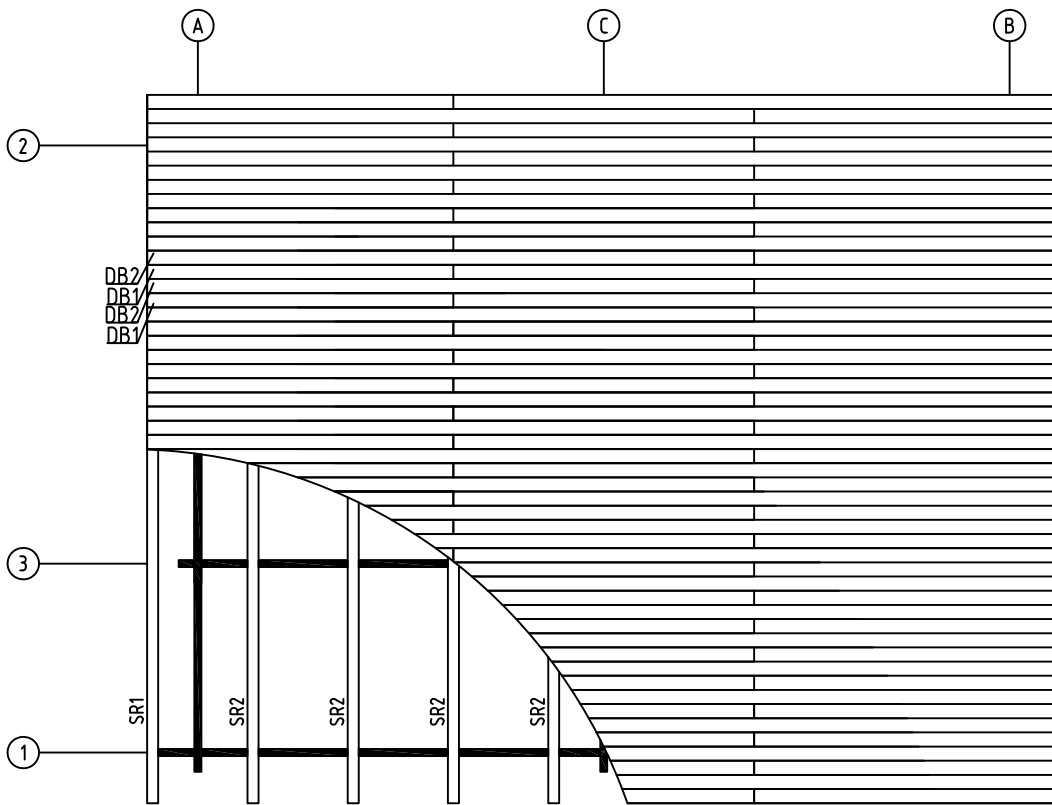

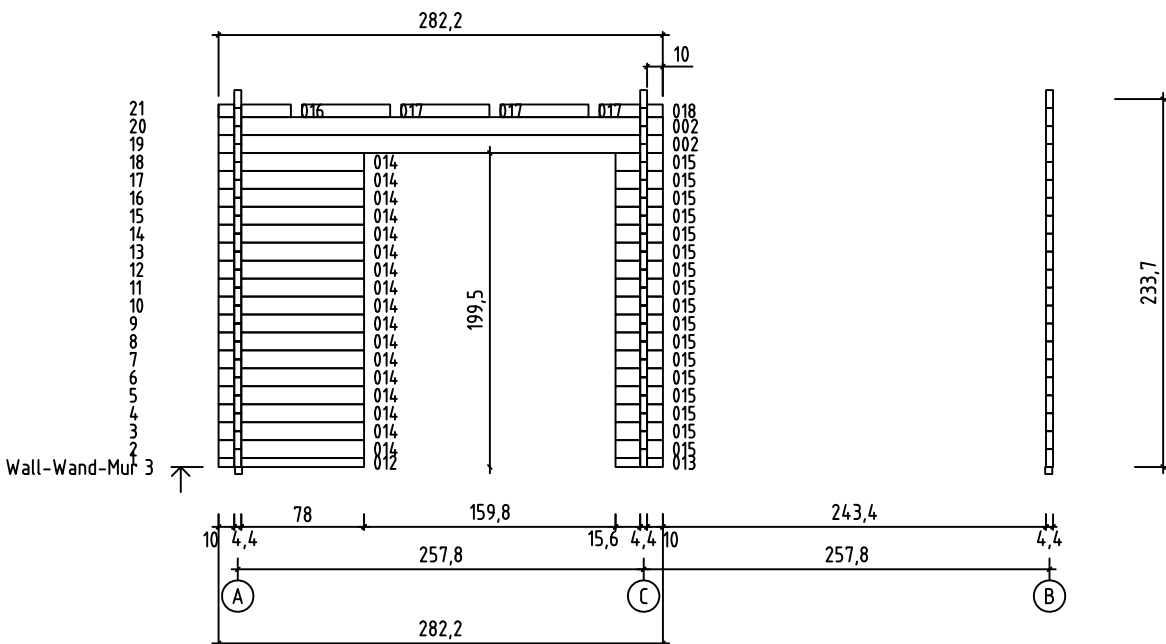
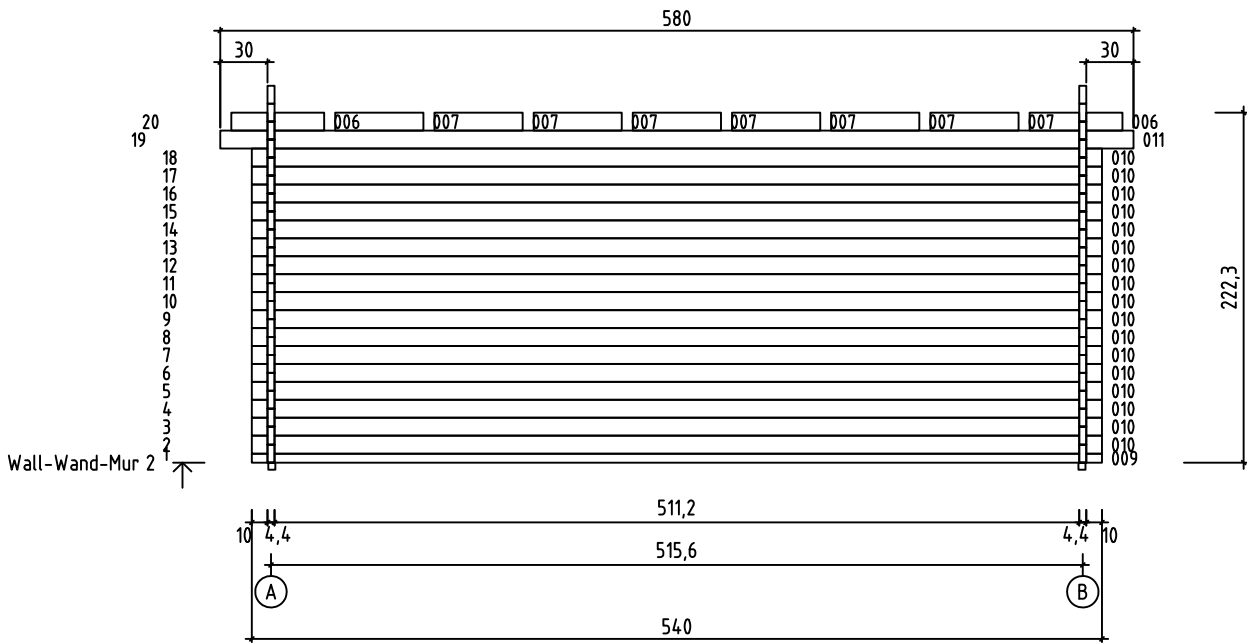
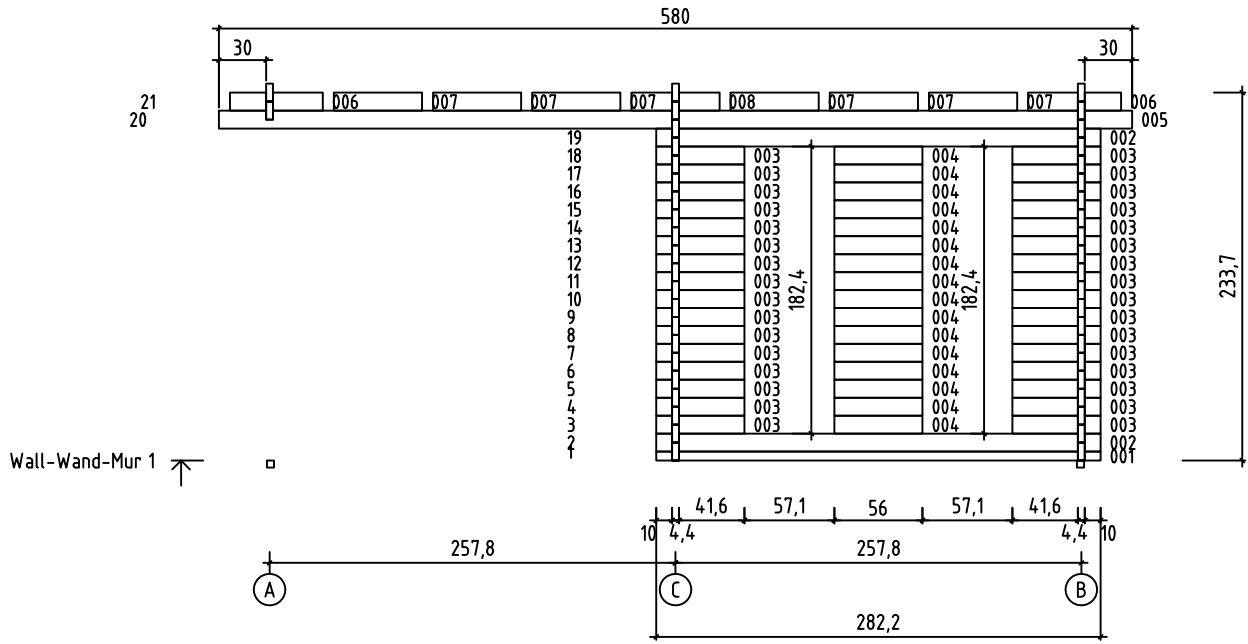

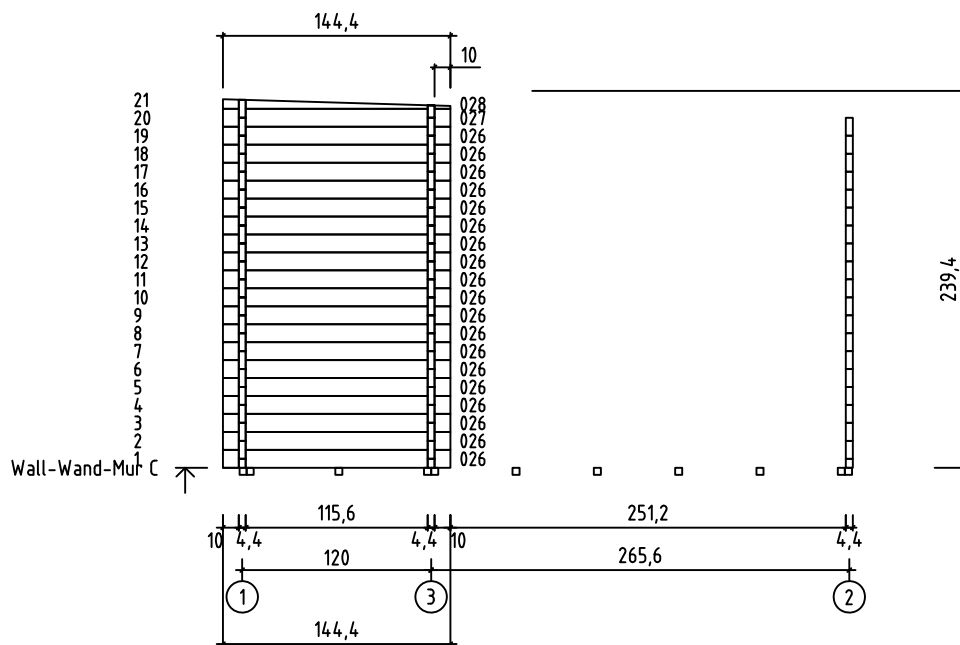
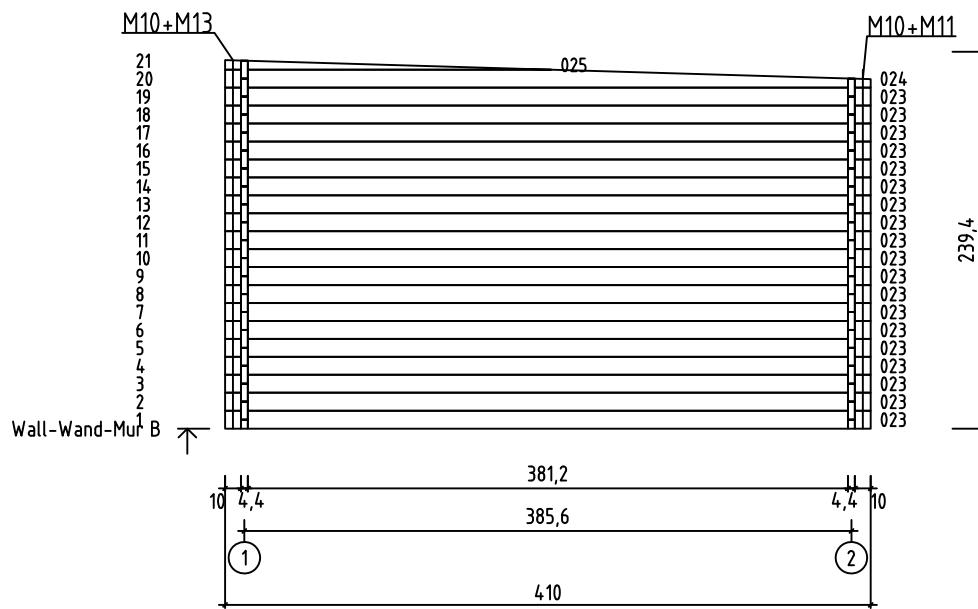
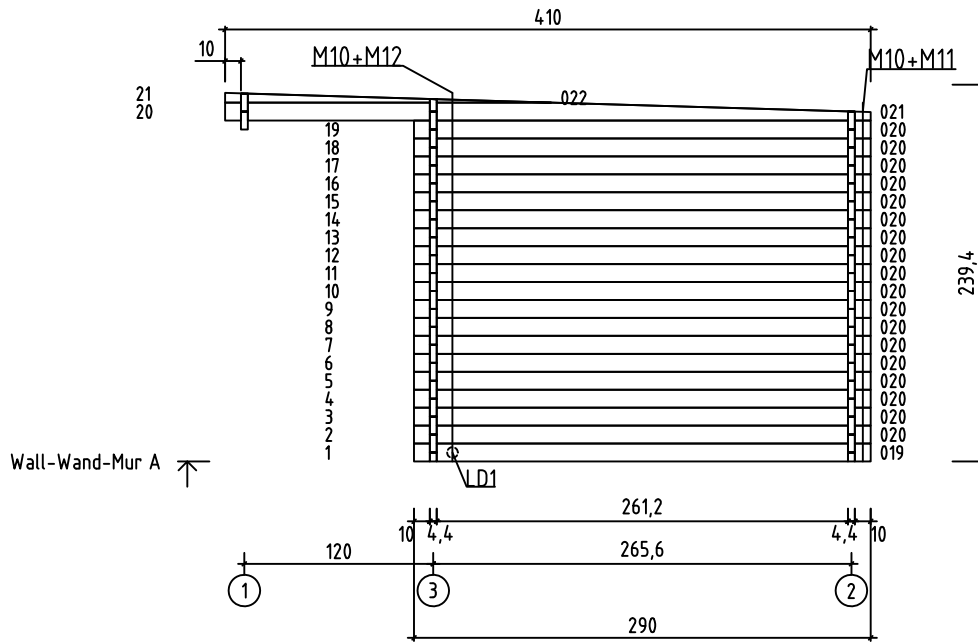

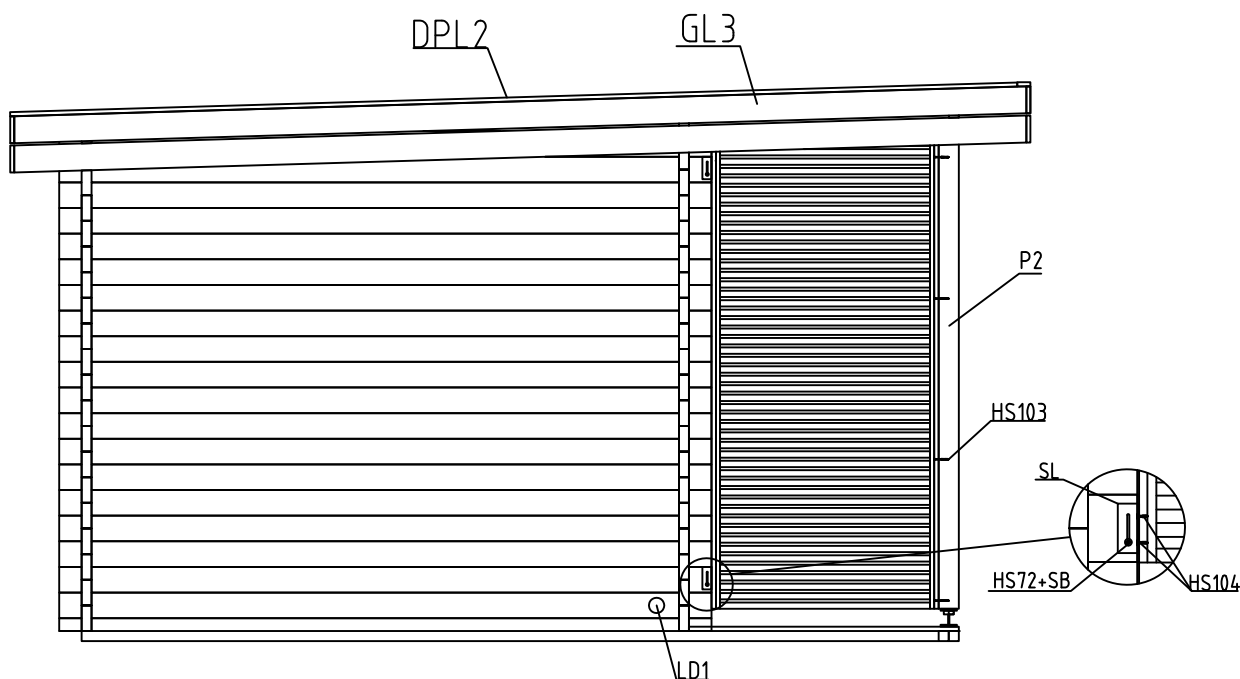
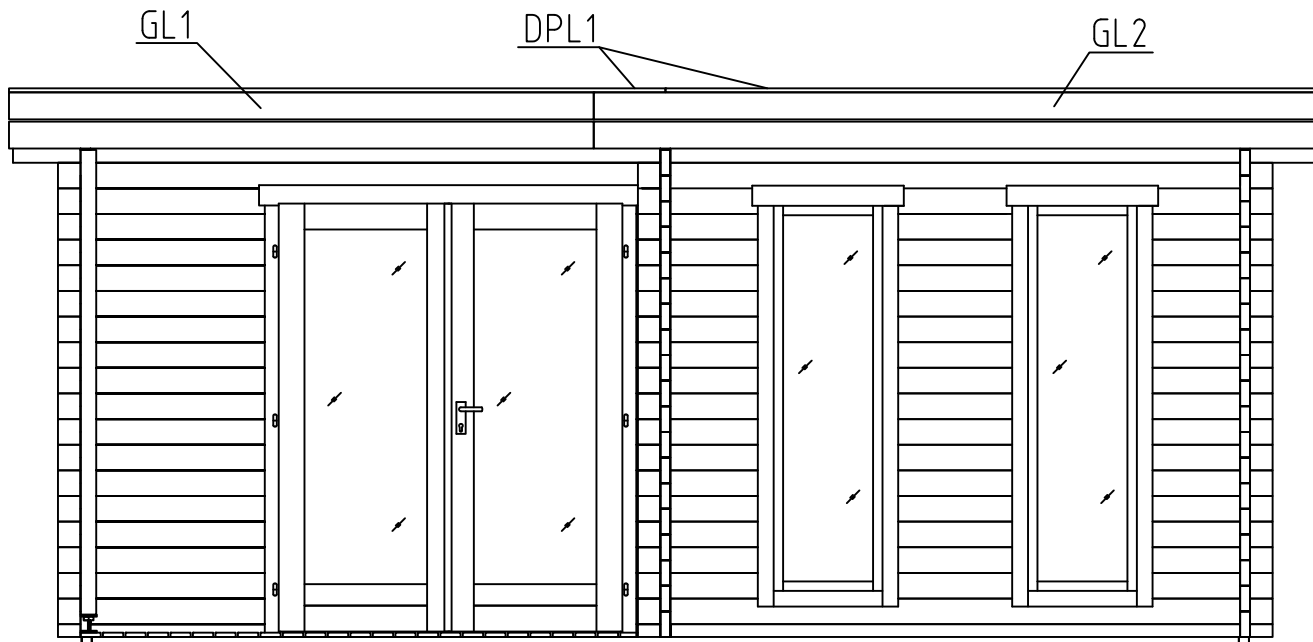



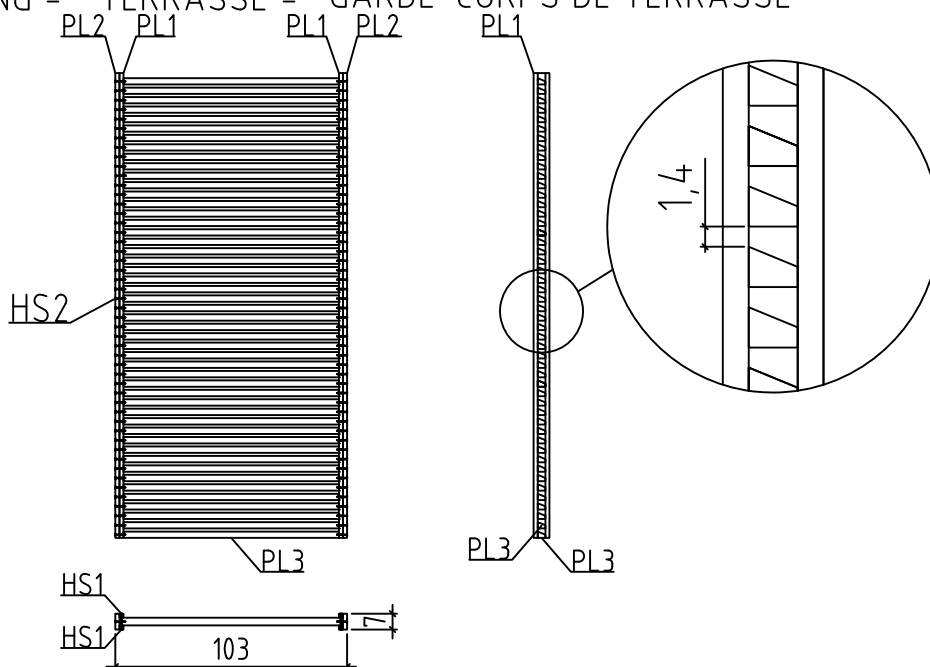

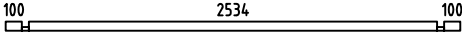
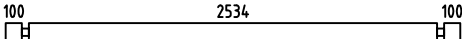

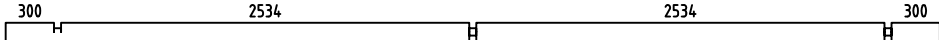



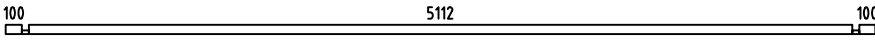
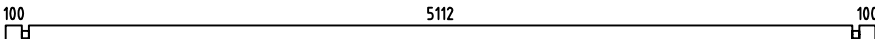
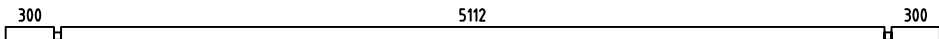
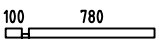

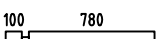



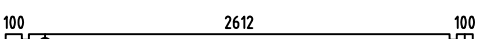
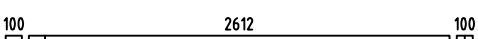
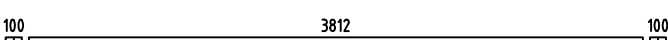
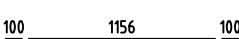
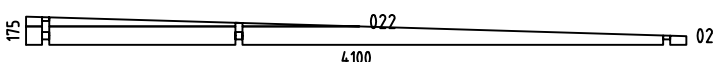
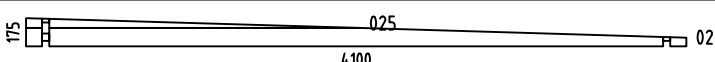
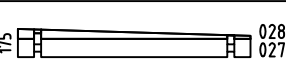

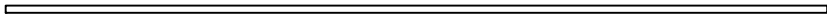
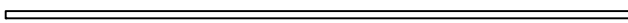
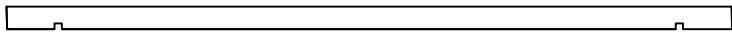
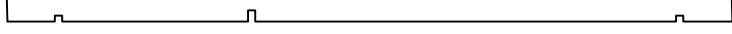

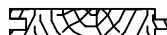

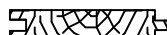













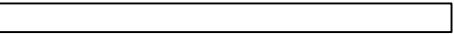
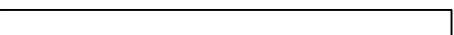

TERRACE RAILING - TERRASSE - GARDE-CORPS DE TERRASSE

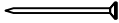

Pos	19.11.2015	Piece list - Stückliste - Liste des pièces Art.Nr. 4413802	7/10	Q.	P (mm)	L (mm)
001				1	44x57	2822
002				4	44x114	2822
003				32	44x114	560
004				16	44x114	560
005				1	44x114	5800
006				4	44x114	590
007				13	44x114	560
008				1	44x114	560
009				1	44x57	5400
010				17	44x114	5400
011				1	44x114	5800
012				1	44x57	924
013				1	44x57	300
014				17	44x114	924
015				17	44x114	300
016	□ 			1	44x80	460
017	□ 			3	44x80	560
018	□ 			1	44x80	402
019				1	44x114	2900
020				18	44x114	2900
023				19	44x114	4100
026				19	44x114	1444
WA-1				1		
WB-1				1		
WC-1				1		

Pos	19.11.2015	Piece list - Stückliste - Liste des pièces Art.Nr. 4413802	8/10	Q.	P (mm)	L (mm)
IAR2		FOUNDATION - FUNDAMENT - FONDATION 		11	45x45	5100
IAR1		FOUNDATION - FUNDAMENT - FONDATION 		2	45x45	3890
SR1		RAFTER - DACHSPARREN - CHEVRON 		6	70x140	4506
SR2		RAFTER - DACHSPARREN - CHEVRON 		4	70x140	4506
		FLOOR BOARDS - FUSSBODENBRETTER - LAME DE PLANCHER 		29	90x18	3808
		FLOOR BOARDS - FUSSBODENBRETTER - LAME DE PLANCHER 		28	90x18	2608
DB2		ROOF BOARDS - DACHBRETTER - VOLIGES 		51	90x18	3845
DB1		ROOF BOARDS - DACHBRETTER - VOLIGES 		51	90x18	1955
SV		TERRACE BOARDS - TERRASSENBRETTER - PLANCHER DE TERRASSE 		26	90x19	1200
FL		FLOOR FILLET-FUSSBODENLEISTE - CORNIERE DE FINITION DU PLANCHER 			18x18	17.83
DPL1		ROOFING FELT FILLET - DACHPAPPENLEISTE - BAGUETTE DE FIXATION DU FEUTRE BITUMEUX 		2	18x58	2860
DPL2		ROOFING FELT FILLET - DACHPAPPENLEISTE - BAGUETTE DE FIXATION DU FEUTRE BITUMEUX 		2	18x58	4542
M11		TREADED ROD M10 - GEWINDESTANGE M10 - TIGE FILETÉE M10 		2		250
M12		TREADED ROD M10 - GEWINDESTANGE M10 - TIGE FILETÉE M10 		1		270
M13		TREADED ROD M10 - GEWINDESTANGE M10 - TIGE FILETÉE M10 		1		370
M10		TREADED ROD M10 - GEWINDESTANGE M10 - TIGE FILETÉE M10 		4		2000
PL1		FILLE FOR TERRACE RAILING - LEISTE FÜR TERRASSE - BAGUETTE POUR CORPS DE TERRASSE 		4	18x18	2067
PL2		FILLE FOR TERRACE RAILING - LEISTE FÜR TERRASSE - BAGUETTE POUR CORPS DE TERRASSE 		2	18x70	2067
PL3		FILLE FOR TERRACE RAILING - LEISTE FÜR TERRASSE - BAGUETTE POUR CORPS DE TERRASSE 		49	28x34	994
P		POST - PFOSTEN - POTEAU 		1	70x70	2067
GL3		EAVES BOARD - TRAUFBRETT - BANDEAU DE TOIT 		4	18x120	4506
GL1		GABLE MOULDING - GIEBELLEISTE - PLANCHE DE RIVE 		4	18x120	2600
GL2		GABLE MOULDING - GIEBELLEISTE - PLANCHE DE RIVE 		4	18x120	3236
		WINDOW HANDLE FITTINGS-FENSTERGRIF - POIGNÉE D'OUVERTURE DE FENETRE 		4		
LD1		LID FOR TREADED ROD HOLE - ABDECKUNG FÜR GEWINDESTANGENÖFFNUNG - COUVERCLE POUR ACCÈS RÉGLAGÉ TIGE FILETÉE 		1		

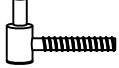
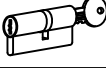
Pos	19.11.2015	Piece list - Stückliste - Liste des pièces Art.Nr. 4413802	9/10	Q.	P (mm)	L (mm)
		LENGTHENING BOLT FOR TREADED ROD - VERLÄNGERUNGSMUTTER FÜR GEWINDESTANGE - MANCHON DE RACCORDEMENT DE TIGE FILETÉE		5		
		DRIVE NUT TREADED ROD - EINSHLAGMUTTER FÜR GEWINDESTANGE - ÉCROU A FRAPPER POUR TIGE FILITÉE		5		
		NUT FOR TREADED ROD - MUTTER FÜR GEWINDESTANGE - ÉCROU POUR TIGE FILETÉE		5		
		PLAIN WASHER TREADED ROD - UNTERLEGSSCHEIBE FÜR GEWINDESTANGE - RONDELLE PLATE POUR TIGE FILETÉE		5		
HS104		SCREW FOR SLIDING WALL TIE - SCHRAUBEN FÜR WAND SCHIEBEREGLER - VIS DE SABOT METALLIQUE POR FIXATION MUR		8	3.5x20	
HS1		SCREW FOR FIXING TERRACE RAILING - SCHRAUBE FÜR TERRASSE VIS DE FIXATION DE GARDE-CORPS DE TERRASSE		24	3X30	
		SCREW FOR GABLE MOULDING - SCHRAUBEN FÜR GIEBELLEISTE - VIS DE FIXATION POUR PLANCHE DE RIVE		96	3.5x50	
		SCREW FOR DOOR FILLET - SCHRAUBE ZUR BEFESTIGUNG TÜRLEISTE - VIS D'ASSEMBLAGE DU CADRE DE PORTE		5	3x30	
HS103		SCREW FOR FIXING TERRACE RAILING - SCHRAUBE FÜR TERRASSE VIS DE FIXATION DE GARDE-CORPS DE TERRASSE		4	4.5x80	
		SCREW FOR POST - SCHRAUBEN FÜR PFOSTEN - VIS DE FIXATION DES POTEAUX		2	4.5x80	
		SCREW FOR FIXING TERRACE RAILING - SCHRAUBE FÜR TERRASSE VIS DE FIXATION DE GARDE-CORPS DE TERRASSE		98	4x40	
		SCREW FOR EAVES BOARDS - SCHRAUBEN FÜR TRAUFBRETTER - VIS DE FIXATION POUR BANDEAU DE TOIT		80	4x40	
		SCREW FOR ROOF BEAMS - SCHRAUBEN FÜR DACHBALKEN - VIS POUR PANNE DE TOIT		24	5x120	
		SCREW FOR GABLE - SCHRAUBEN FÜR GIEBEL - VIS POUR FIXATION DES PIGNONS		8	5x120	
		SCREW FOR FUNDAMENT - SCHRAUBEN ZUR BEFESTIGUNG FUNDAMENT - VIS POUR FONDATION		22	5x90	
		SCREW FOR POS. 006-009; 017-019 - SCHRAUBEN FÜR POS. 006-009; 017-019 VIS POUR FIXATION DERNIÈRE RANGÉE MADRIERS (MURS AVANT ET ARRIÈRE)		46	6x180	
HS72		SCREW FOR SLIDING WALL TIE - SCHRAUBEN FÜR WAND SCHIEBEREGLER - VIS DE SABOT METALLIQUE POR FIXATION MUR		2	6x40	
		SCREW FOR POST HEIGHT ADJUSTMENT - SCHRAUBEN FÜR REGULIERUNGSSCHRAUBE FÜR PFOSTEN - VIS DE FIXATION DE SUPPORT REGLABLE DE POTEAU		8	6x50	
		ZN NAIL FOR TERRACE - ZN NÄGEL FÜR TERRASSENBRETTER - POINTE POUR PLANCHER DE TERRASSE		156	2.1x50	
		ZN NAIL FOR FLOOR FILLET - ZN NÄGEL FÜR FUSSBODENLEISTE - POINTE POUR CORNIÈRE DE FINITION DU PLANCHER		44	1.4x40	
		HAMMER BLOCK - SCHLAGHOLZ - CALLE DE FRAPPE		1		
		SCREW FOR DOORSTEP - SCHRAUBEN FÜR TÜRSCHWELLE - VIS DE FIXATION DU SEUIL DE PORTE		3	4.5x65	
		ZN NAIL FOR ROOFING FELT FILLET - ZN NÄGEL FÜR DACHPAPPENLEISTE - POINTE POUR BAGUETTE FIXATION FEUTRE BITUMEUX		34	2x40	
		BOLT FOR WINDOW HANDLE FITTINGS - BOLZEN FÜR FENSTERGRIFF BESCHLAG BOULON POUR POIGNÉE D'OUVERTURE DE FENETRE		8		
SB		PLAIN WASHER - UNTERLEGSSCHEIBE - RONDELLE PLATE		2		

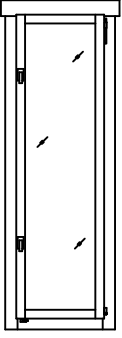
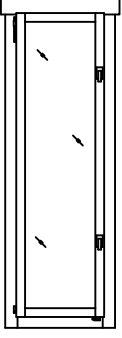
Pos	19.11.2015	Piece list - Stückliste - Liste des pièces Art.Nr. 4413802	10/10	Q.	P (mm)	L (mm)
SL	SLIDING WALL TIE - SCHIEBEREGLER FÜR WAND - SABOT MÉTALLIQUE POUR FIXATION MUR			2		
	ZN NAIL FOR ROOF - ZN NÄGEL FÜR DACHBRETTER - POINTE POUR TOIT			645	2x50	
	ZN NAIL FOR FLOOR - ZN NÄGEL FÜR FUSSBODENBRETTER - CLOUS POUR PLANCHER			450	2x50	
	DOOR HANDLE FITTINGS-TÜRGRIF - SET DE GARNITURES DE SERRURE DE PORTE			1		
	SET OF DOOR LOCK COVERS - SCHLOSSBLENDEN - SET DE GARNITURES DE SERRURE DE PORTE			1		
	MALE BOLT HINGE FOR DOOR - TÜRRIEGEL - PARTIE MALE DE CHARNIERE DE PORTE			6		
	CYLINDER LOCK -ZYLINDERSCHLOSS - CYLINDRE DE SERRURE			1		
	POST HEIGHT ADJUSTMENT - REGULIERUNGSSCHRAUBE FÜR PFOSTEN - SUPPORT RÉGLABLE DE POTEAU			1		
	WINDOW - FENSTER - FENETRE 560x1780 AK.1.100.PSP	DGP		1		
						
	WINDOW - FENSTER - FENETRE 560x1780 AK.1.100.PSV	DGP		1		
						
	DOOR - TÜR - PORTE 1588x1957 TUK.1.100.PVP.MM	DGP		1		
	