

Jamaica
Art. Nr. 442400

1/11

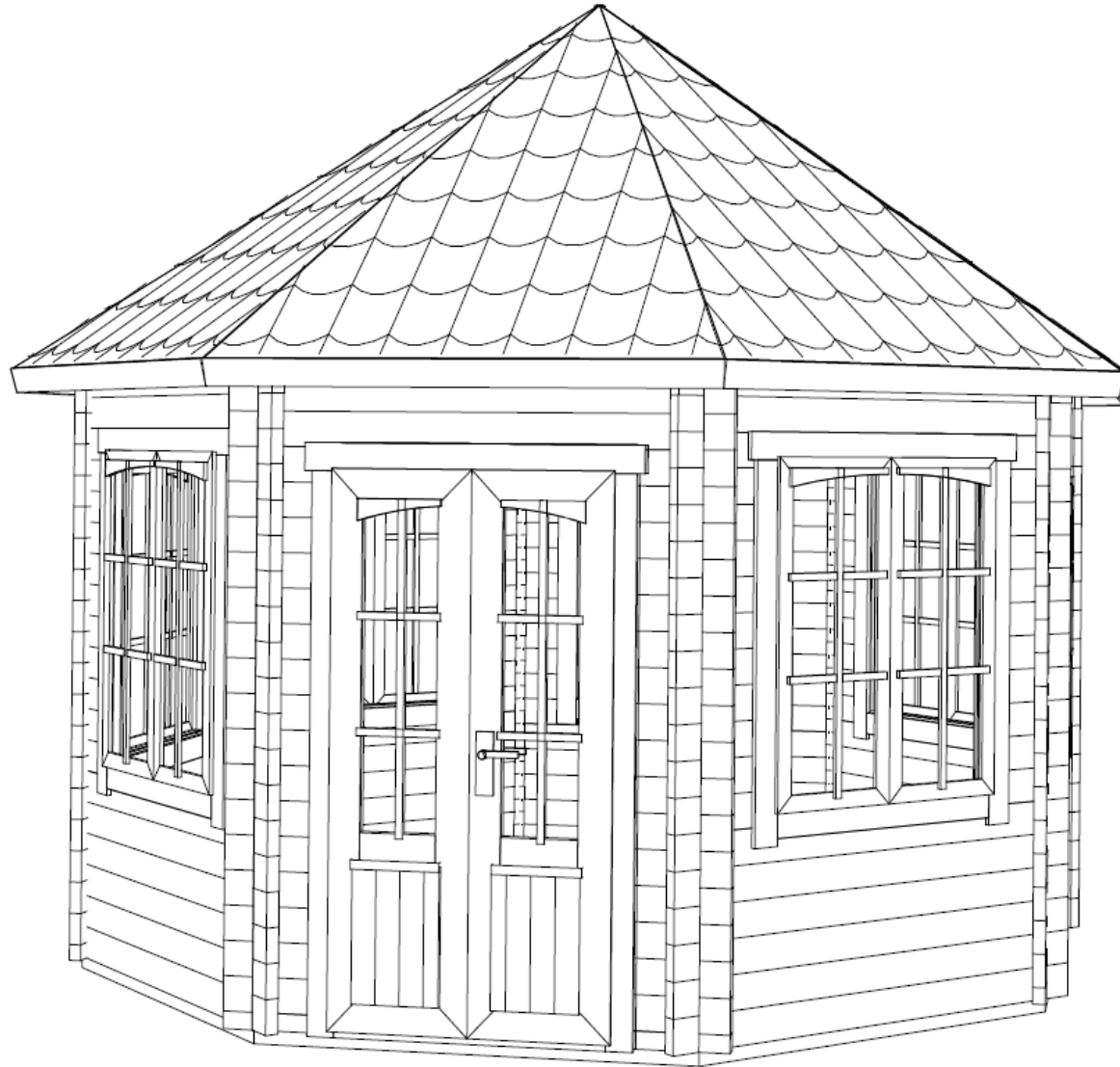

30.09.2014

GROUNDPLAN - GRUNDPLAN - PLAN DE MASSE

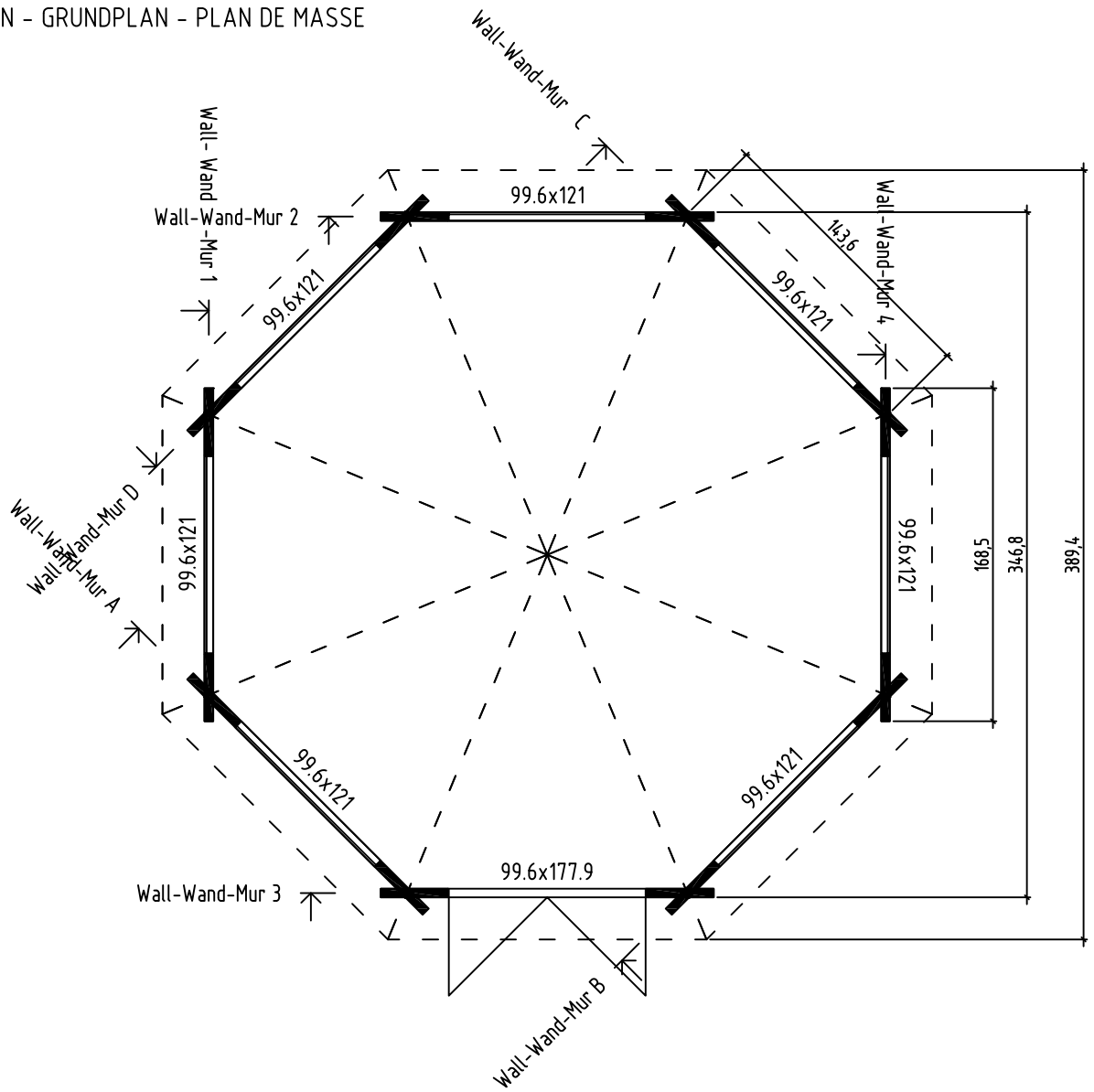

FOUNDATION - FUNDAMENT - FONDATION

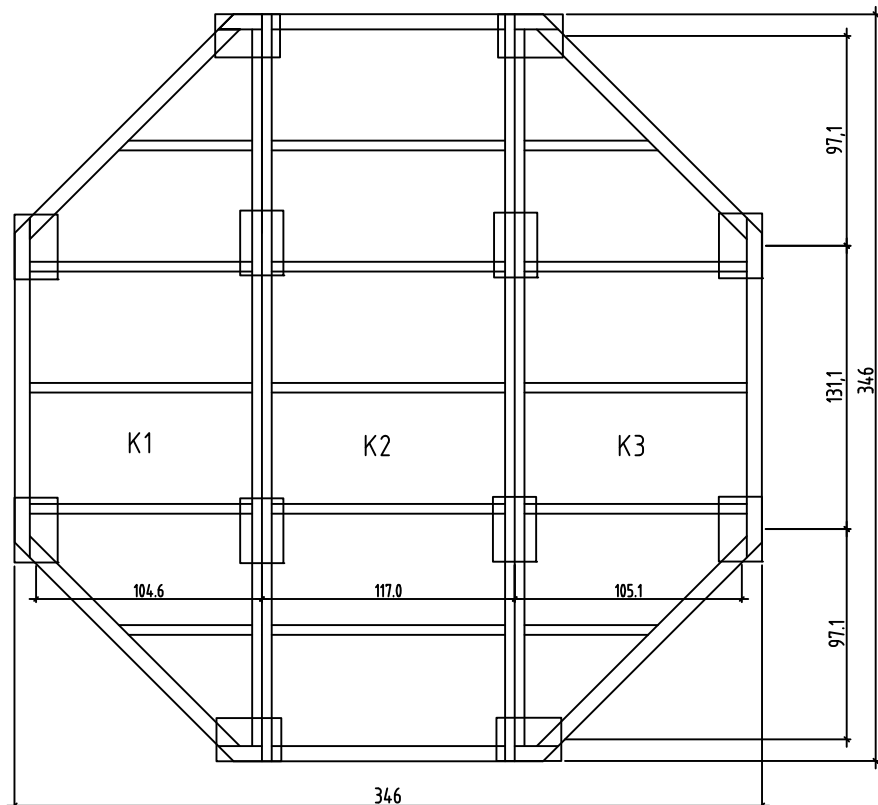

FLOOR BOARDS - FUSSBODENBRETTER - PLAN POSE PLANCHER

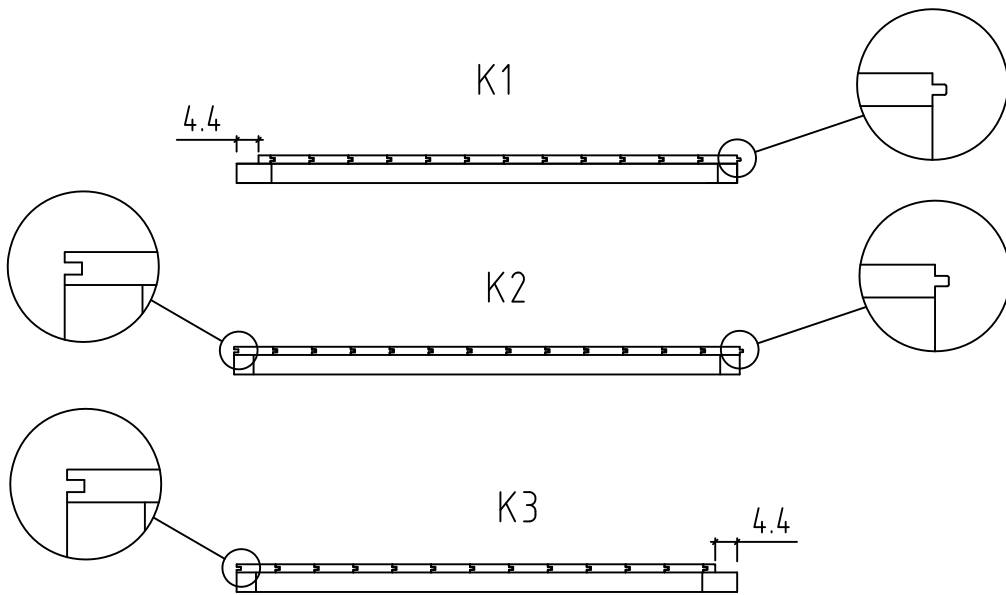
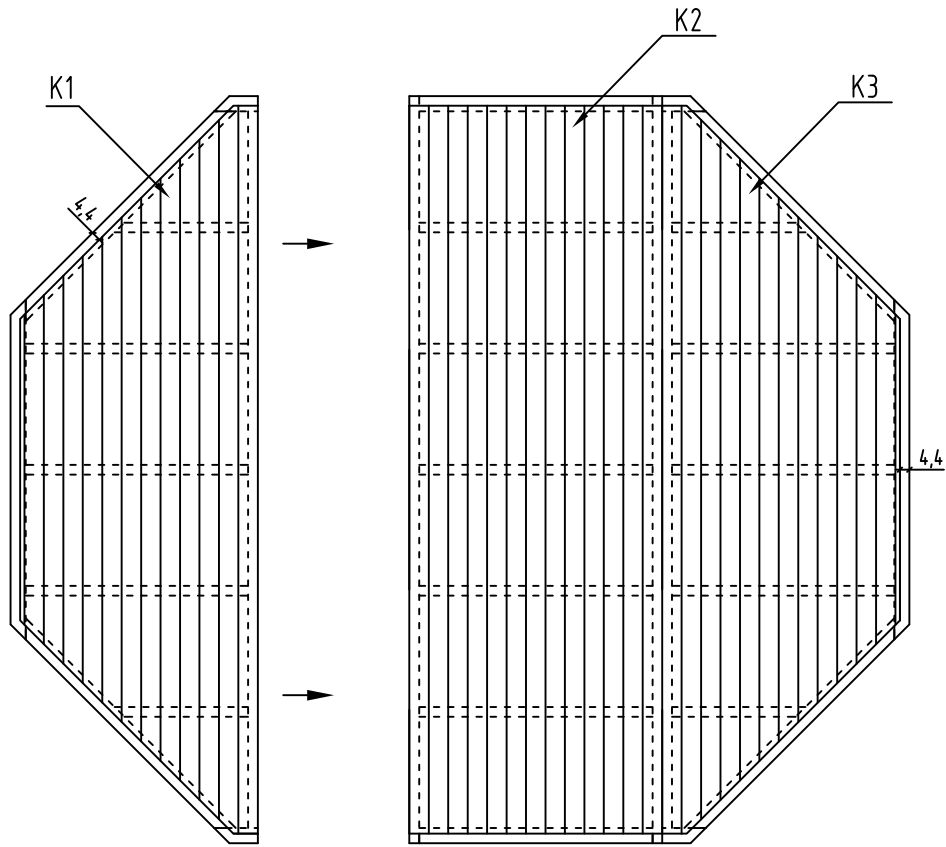

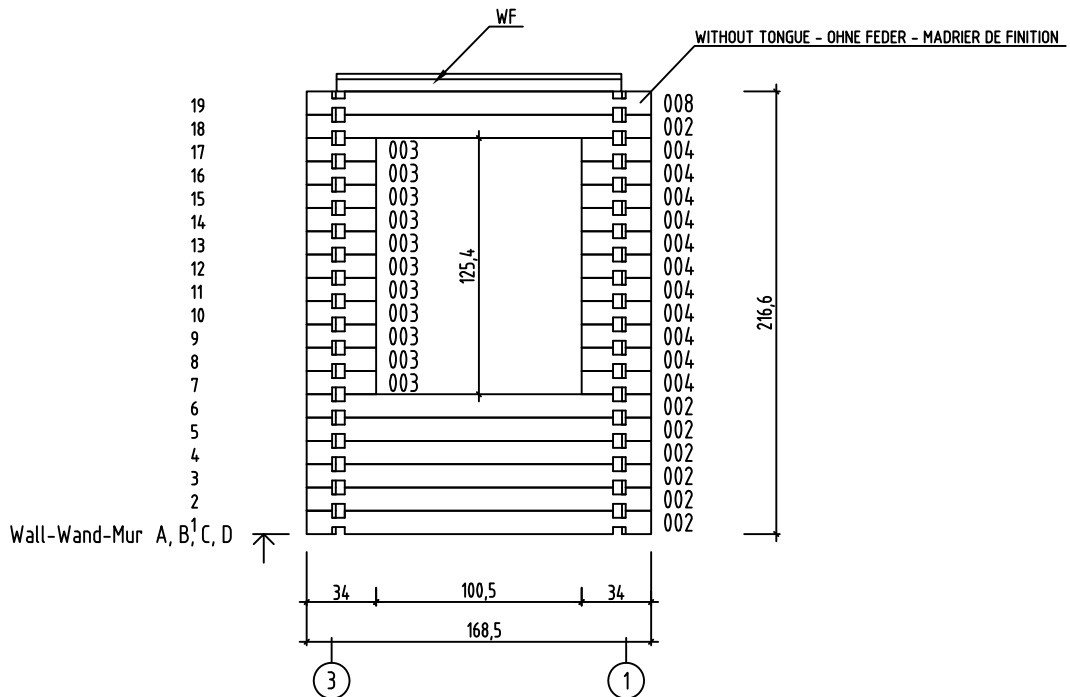
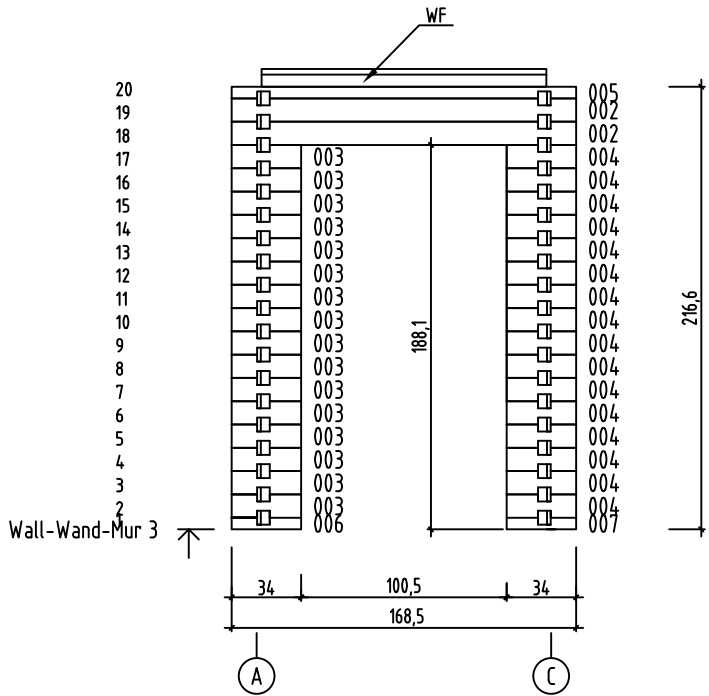
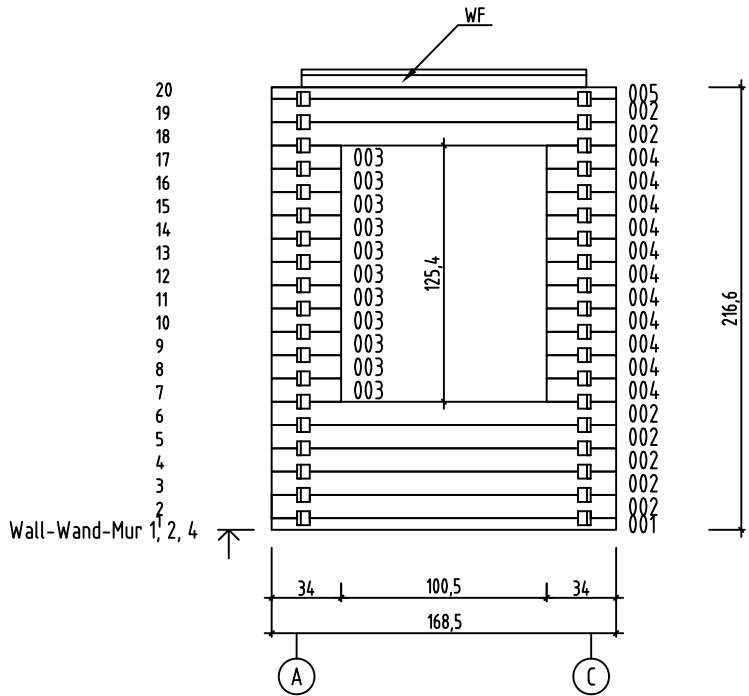

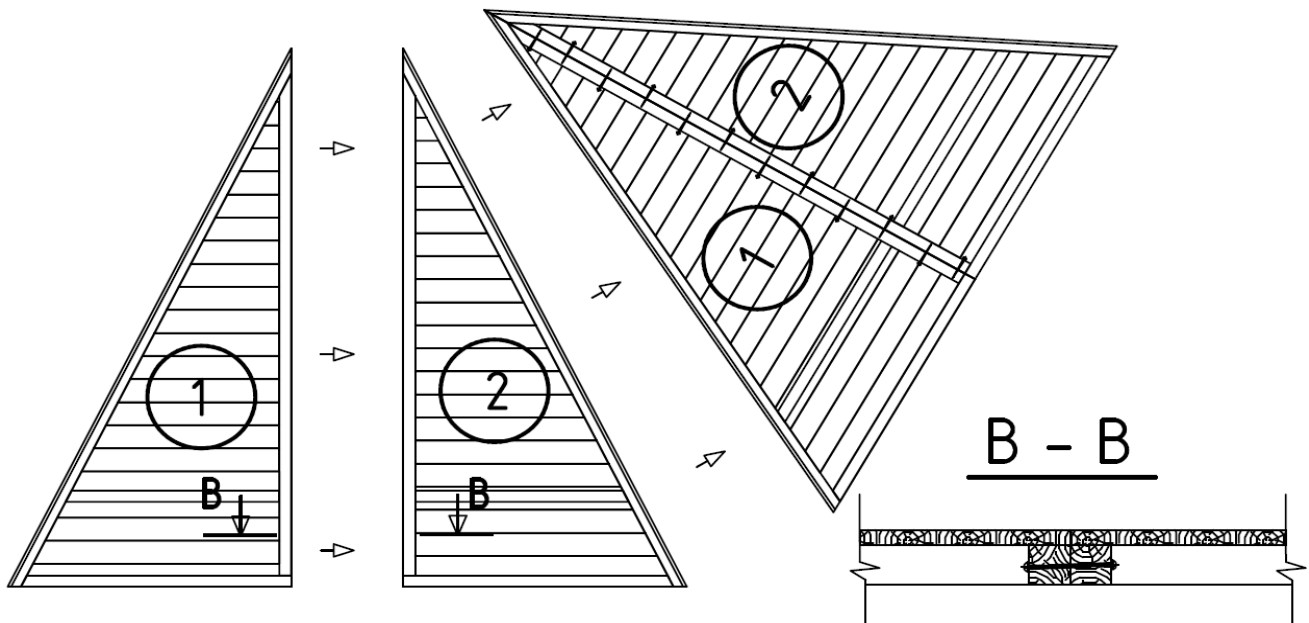

ATTACH LEFT AND RIGHT (1 & 2) ROOF PANELS TOGETHER, USING 2 SCREWS HS1 (12 PCS TOTAL) AT THE LOWEST PART (B-B). THEN AT REGULAR INTERVALS USING THE REMAINING 10 SCREWS, ATTACHING THEM ON ALTERNATING SIDES.

VERBINDEN SIE DIE LINKE UND RECHTE (1 & 2) DACHFLÄCHE MIT DEN SCHRAUBEN HS1 (12 STÜCK INSGESAMT) BEGINNEND AN DER TIEFSTEN STELLE (BB). DANN IN REGELMÄßIGEN ABSTÄNDEN DIE RESTLICHEN SCHRAUBEN VON BEIDEN SEITEN BIS HIN ZUR SPITZE ANBRINGEN.

ASSEMBLER LES PANNEAUX DE TOIT 1 ET 2 AVEC LES VIS (HS1 - 12 VIS AU TOTAL) EN LES RÉPARTISSANT À INTERVALLE RÉGULIER COMME LE MONTRE LE DESSIN CI-DESSOUS.

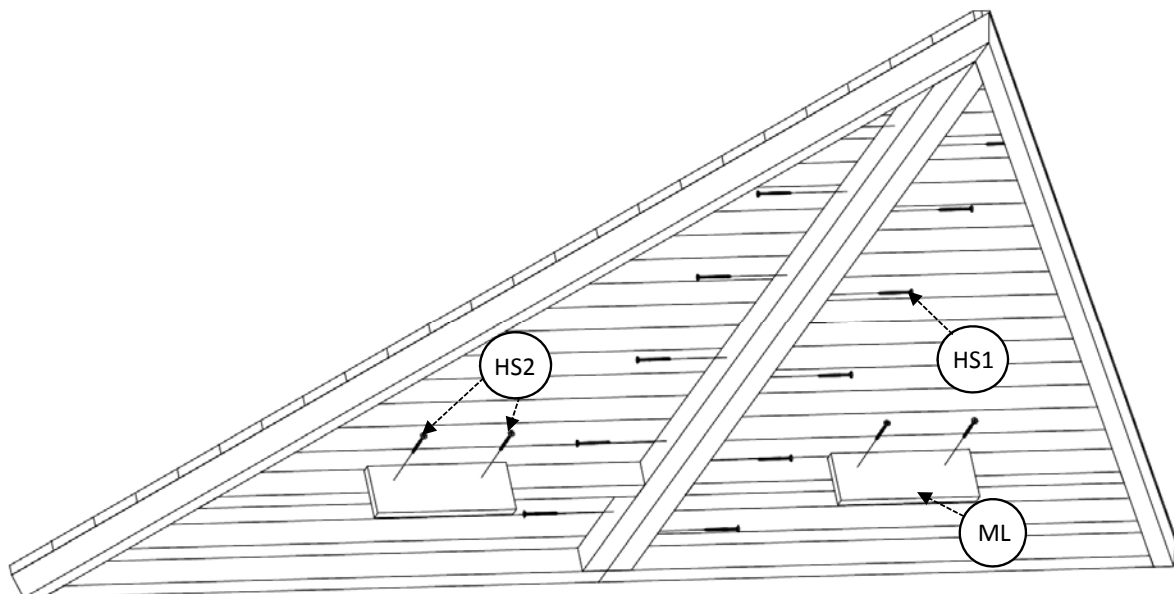

USING 2 SCREWS (HS2) ATTACH ML TO THE LOWER PART CROSS BATTEN ON THE UNDERSIDE OF THE ROOF PANEL (THESE ARE TEMPORARY SUPPORTS).

MIT DEN ZWEI SCHRAUBEN (HS2) BEFESTIGEN SIE DIE KOMPONENTE ML AUF DEM UNTEREN RAHMENTEIL. HIERBEI HANDELT ES SICH UM STÜTZEN ZUR BEFESTIGUNG DER DACHFLÄCHEN.

POUR LA MISE EN PLACE DES PANNEAUX DE TOIT, VEUILLEZ VISSER TEMPORAIREMENT LES DÉTAILS ML AUX TRAVERSES INTERMÉDIAIRES AVEC LES 2 VIS (HS2) POUR CHAQUE DÉTAIL ML. UNE FOIS LA MISE EN PLACE DE LA TOITURE TERMINÉE, VOUS POURREZ LES ENLEVER.

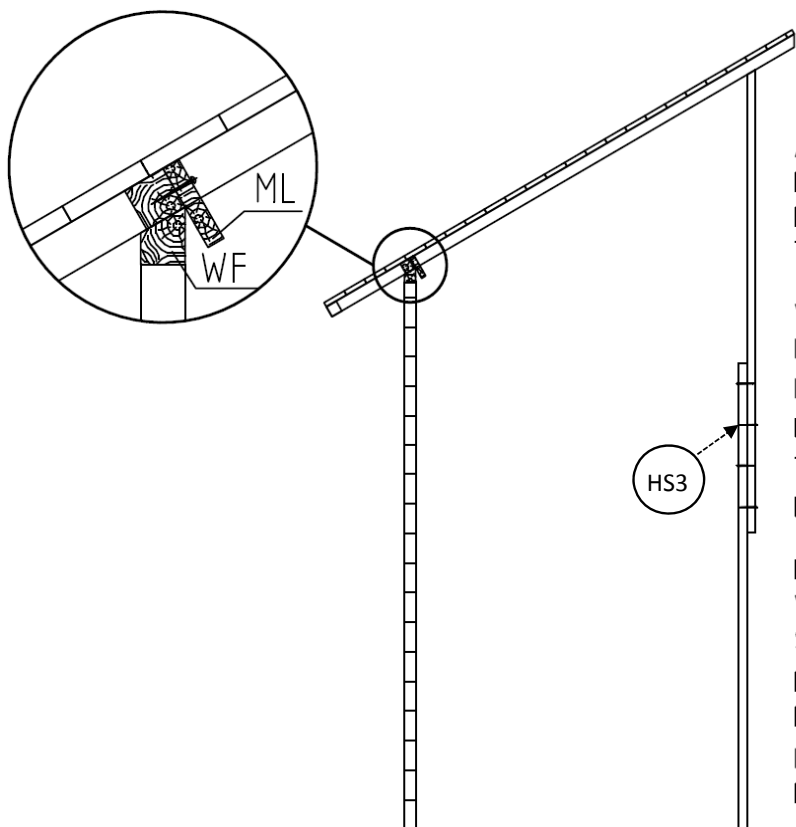

ATTACH TOGETHER PARTS AB SO THAT THE ENTIRE LENGTH IS 3230 MM USING 4 SCREWS PROVIDED HS3. THIS IS A TEMPORARY SUPPORT TO HELP YOU MOUNT THE ROOF.

VERBINDEN SIE DIE BEIDEN KOMPONENTEN A & B MITTELS DER VIER SCHRAUBEN HS3 MITEINANDER. SO DASS DIE LÄNGE 3.230 MM BETRÄGT. HIERBEI HANDELT ES SICH UM EINE TEMPORÄRE STÜTZE ZUR INSTALLATION DER DACHFLÄCHEN.

POUR LA MISE EN PLACE DES PANNEAUX DE TOIT, VEUILLEZ VISSER AVEC 4 VIS (HS3) LES SUPPORTS DE MAINTIEN DE TOIT AB ENSEMBLE DE TELLE SORTE À OBTENIR UN POTEAU D'UNE HAUTEUR TOTALE DE 3 230 MM. UNE FOIS LA MISE EN PLACE DE LA TOITURE TERMINÉE, VOUS POURREZ L'ENLEVER.

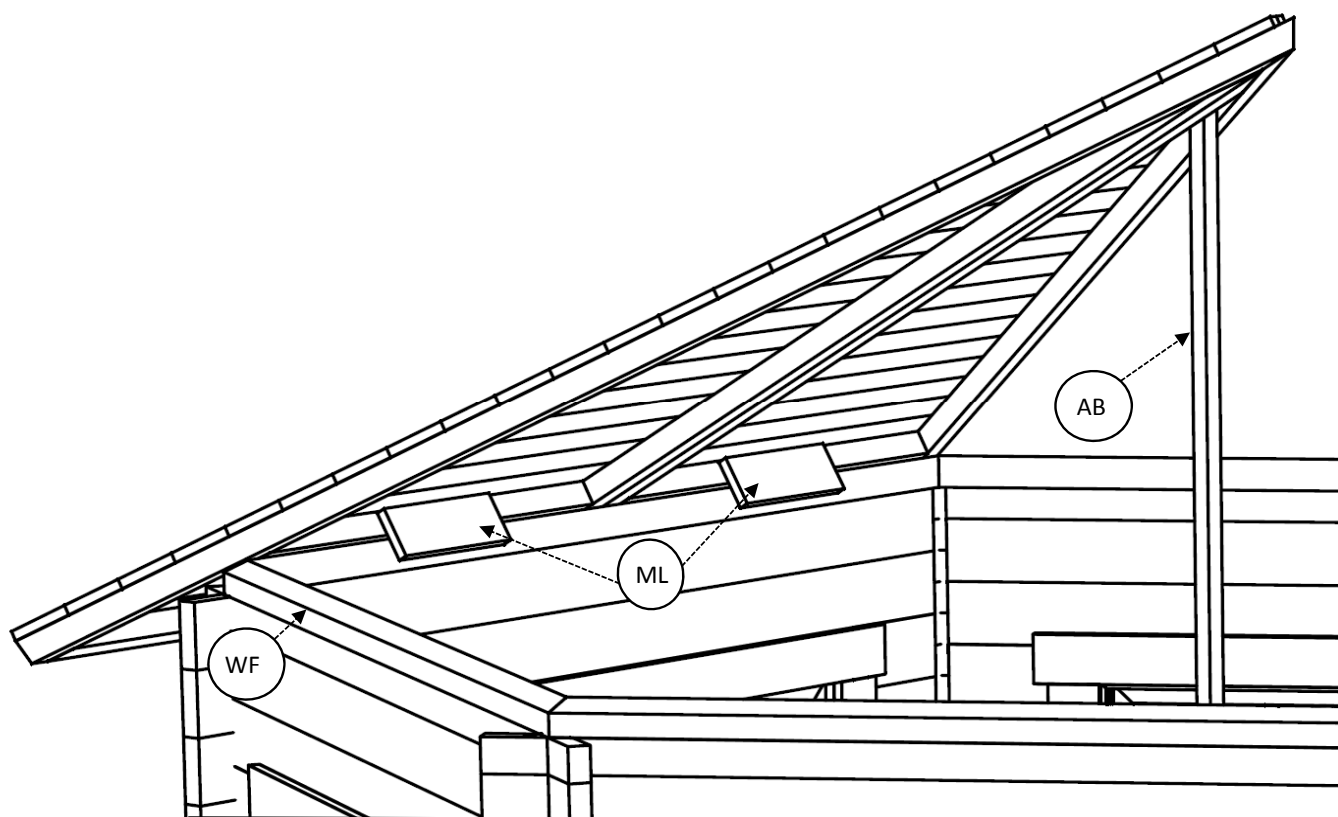

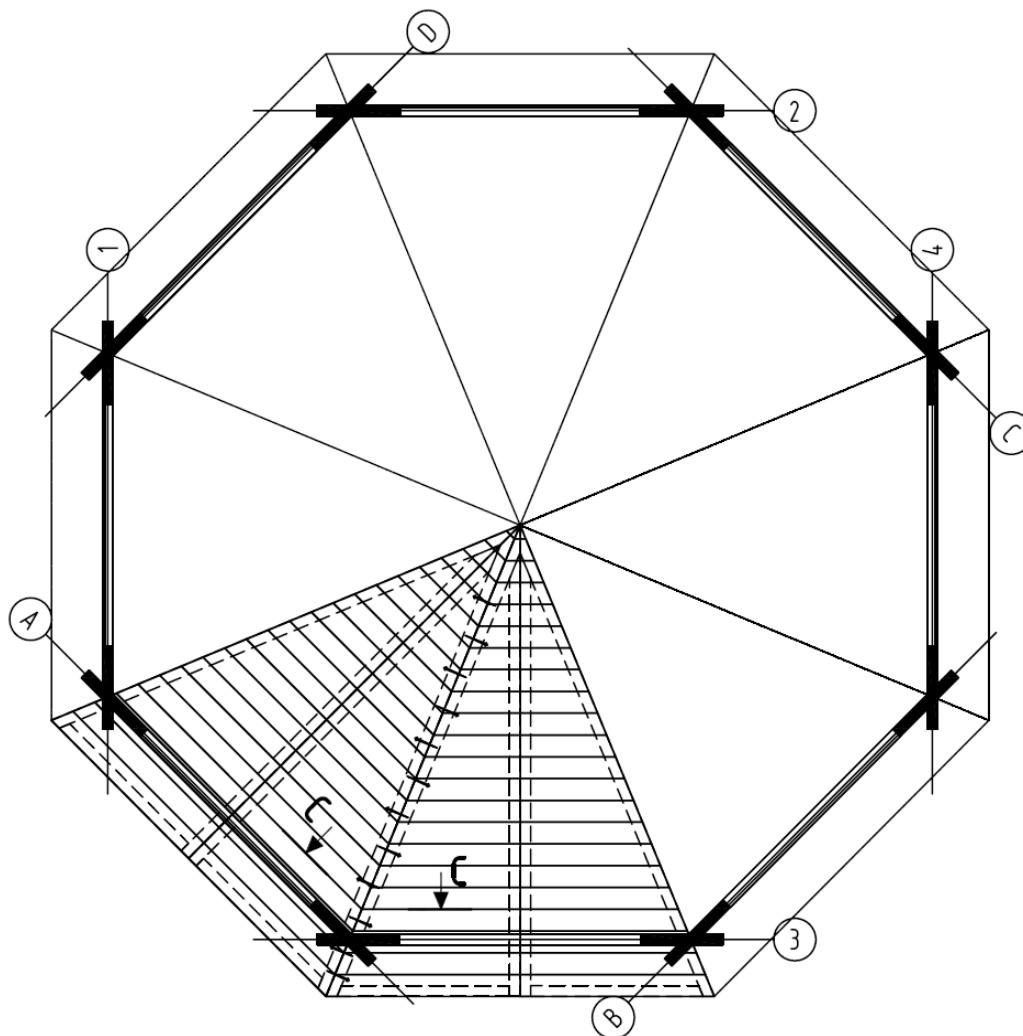

MOUNT THE FIRST ROOF SECTION YOU HAVE CREATED NEXT TO THE SECOND ONE (C-C), (WITH THE HELP OF ROOF SUPPORT AB) - MAKING SURE THEY ARE ALIGNED AND USING SCREWS HS1 (12 PCS) SCREW ALTERNATE SIDES ALL THE WAY UP, (DO NOT TIGHTEN UNTIL ALL PANELS HAVE BEEN ATTACHED, YOU MAY NEED TO ADJUST THE POSITIONING AND HEIGHT AT THE END). ONCE THE CORRECT POSITIONING HAS BEEN ACHIEVED TIGHTEN ALL SCREWS.

MONTIEREN SIE NUN NACHEINANDER DIE EINZELNEN DACHFLÄCHENDREIECKE UNTER ZUHLFFENAHME DER STÜTZE AB. VERBIDNEN SIE DIE EINZELNEN DREIECKE WIEDER MIT DEN SCHRAUBEN HS1 (12 ST.) VOM BODEN BIS ZUR SPITZE. DIE SCHRAUBEN BITTE NICHT SOFORT FEST ANZIEHEN, SO DASS SIE DIE DACHELEMENTE GGF. NOCH JUSTIERT WERDEN KÖNNEN. NACHDEM ALLE DREIECKE AN SEINER KORREKTEN POSITION SIND UND DAS DACH JUSTIERT WURDE, BITTE DIE SCHRAUBEN FEST ANZIEHEN.

PLACER SUR LE TOIT LES ÉLÉMENTS DE TOIT PRÉASSEMBLÉS CÔTE À CÔTE (C - C) , EN VOUS AIDANT DU POTEAU DE MAINTIEN DE TOIT AB. ASSUREZ-VOUS DE LEUR BON ALIGNEMENT ET VISSER LES ENSEMBLE À INTERVALLE RÉGULIER EN UTILISANT LES VIS HS1 (12 VIS POUR FIXER À CHAQUE FOIS 2 PANNEAUX). ATTENTION, NE PAS VISSER À FOND TANT QUE TOUS LES PANNEAUX NE SONT PAS MIS EN PLACE, CAR VOUS AUREZ PEUT-ÊTRE BESOIN D'AJUSTER LE POSITIONNEMENT DE CERTAINS D'ENTRE EUX. UNE FOIS TOUS LES PANNEAUX DE TOIT MIS EN PLACE CORRECTEMENT, ALORS VISSER À FOND.

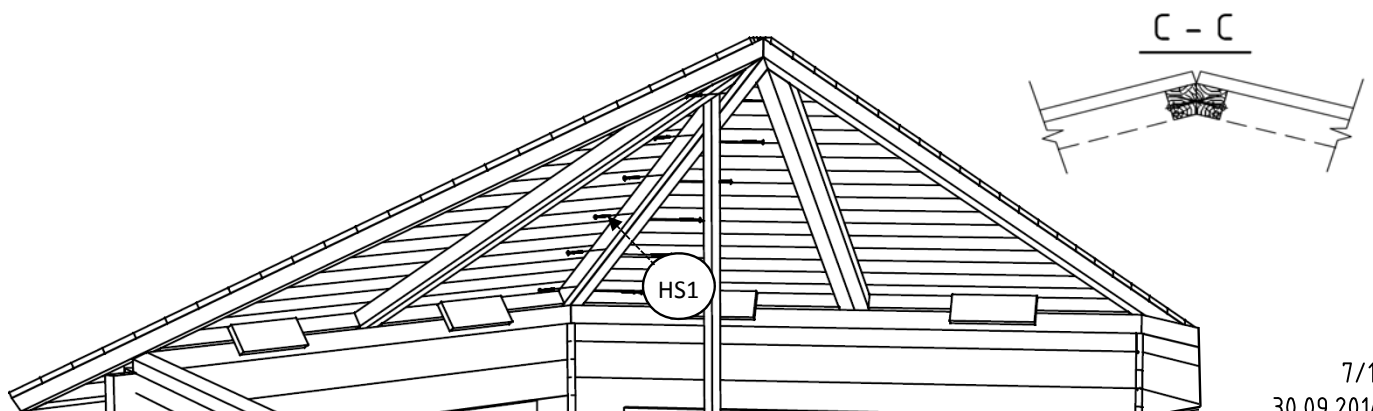

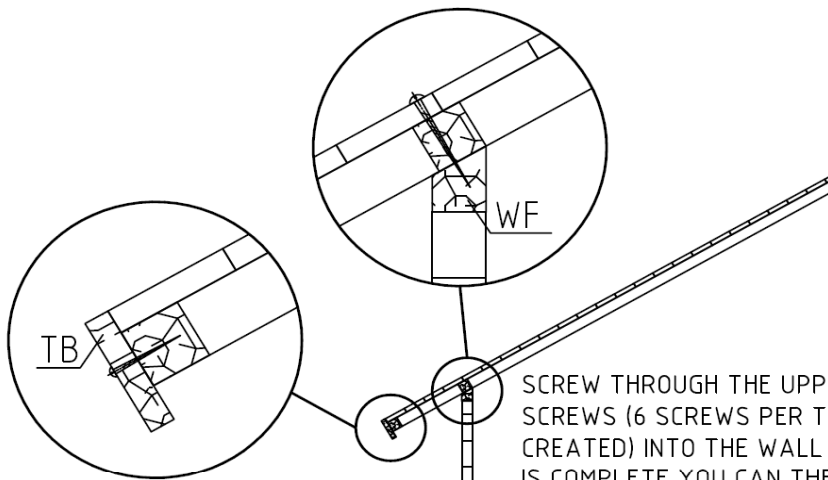

UNDER THE EAVES OF THE ROOF EDGE ATTACH THE FASCIA BOARD TB USING SCREWS PROVIDED HS5 (3 PCS).

ANSCHLIEßEND BRINGEN SIE BITTE DIE UMLAUFENDEN ABSCHLUßBRETTER (TB) MITTELS DER DREI SCHRAUBEN HS5 JEWELS AM UNTEREN RAHMENTEIL DER DACHFLÄCHENDREIECKE AN.

FIXER LES PLANCHES DE RIVES TB AUX EXTRÉMITÉS VISIBLES DES PANNEAUX DE TOIT AVEC LES VIS HS5 (3 VIS PAR PLANCHE).

SCREW THROUGH THE UPPER PART OF THE ROOFING USING HS4 SCREWS (6 SCREWS PER THE DOUBLE PANEL SECTION YOU CREATED) INTO THE WALL SECTION UNDERNEATH (WF). ONCE THIS IS COMPLETE YOU CAN THEN REMOVE THE TEMPORARY SUPPORTS ML AND HS3.

SCHRAUBEN SIE NUN DURCH DIE DACHELEMENTE (B/B, C/C ETC.) DIE SCHRAUBEN HS4 (6 SCHRAUBEN JE DOPPELDREIECK) IN DIE DARUNTER LIEGENDE KOMPONENTE WF UM DIE DACHFLÄCHEN MIT DEN WÄNDEN ZU VERBINDEN. SOBALD DIES ABGESCHLOSSEN IST, KÖNNEN DIE TEMPORÄREN STÜTZEN ML UND A/B ENTFERNT WERDEN.



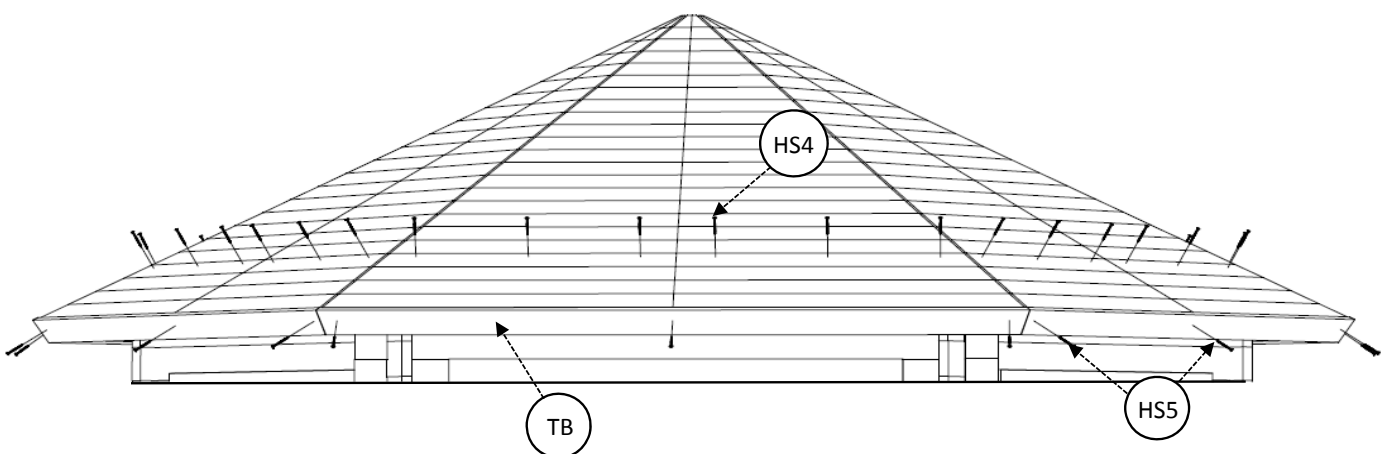







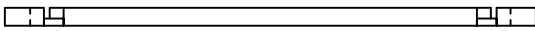

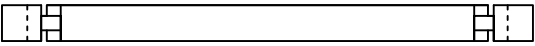



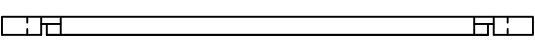

VISSEZ LES PANNEAUX DE TOIT EN PLACE AUX MADRIERS SUPÉRIEURS DE FINITION (WF) EN UTILISANT LES VIS HS4 (6 VIS PAR PANNEAUX PRÉASSEMBLÉS). UNE FOIS TERMINÉE, VOUS POUVEZ ENLEVER LES SUPPORTS ML DE CHAQUE PANNEAU ET LE POTEAU DE MAINTIEN DE TOIT AB.

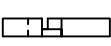

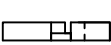

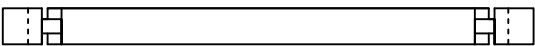

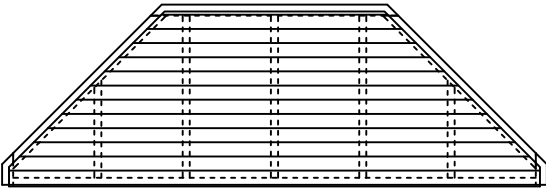
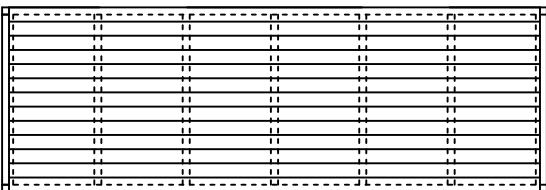
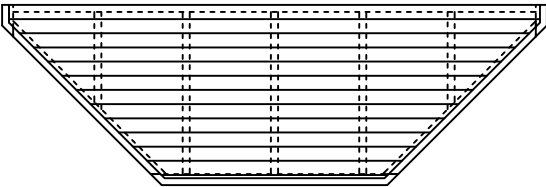

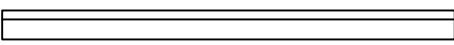
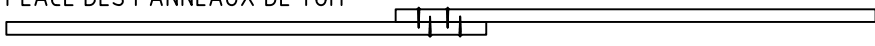
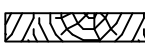
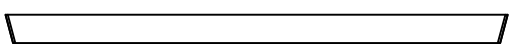

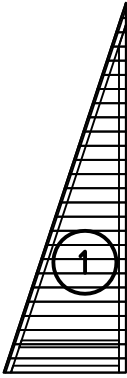
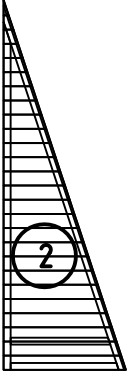

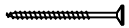
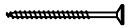

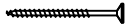
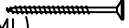
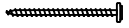
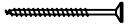
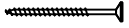
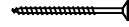
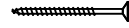
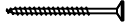
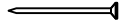
THEN YOU ARE READY TO APPLY SHINGLES OR FELT (NOT SUPPLIED).

NUN KÖNNEN SIE DAMIT BEGINNEN DIE DACHEINDECKUNG ZU VERLEGEN (NICHT IM LIFERUMFANG ENTHALTEN).

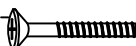
VOUS POUVEZ MAINTENANT PROCÉDER À LA MISE EN PLACE DE LA FINITION DE TOITURE (FOURNIE SÉPARÉMENT EN OPTION).

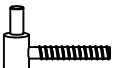
Pos	30.09.2014	ART.NR. 442400	9/11	St.	Profile (mm)	Lenght (mm)
001				3	44x57	1685
002				51	44x114	1685
003				93	44x114	340
004				93	44x114	340
005				4	44x57	1685
006				1	44x114	340
007				1	44x114	340
008				4	44x114	1685
K1	FLOOR ELEMENT - BODENELEMENT - PLANCHER PRÉMONTÉ			1	63x3458x1170	
K2	FLOOR ELEMENT - BODENELEMENT - PLANCHER PRÉMONTÉ			1	63x3458x1144	
K3	FLOOR ELEMENT - BODENELEMENT - PLANCHER PRÉMONTÉ			1	63x3458x1170	
	FLOOR FILLET - FUSSBODENLEISTE - CORNIERE DE FINITION DU PLANCHER				18x18	12.0
WF	WALL FINISHING BOARD - ABSCHLUSSBOHLE - - MADRIER SUPÉRIEUR DE FINITION			8	44x92	1436
AB	ASSEMBLY BATTEN-MONTAGELATTE - BAGUETTES DE MAINTIEN, NÉCESSAIRES À LA - - MISE EN PLACE DES PANNEAUX DE TOIT			2	28x34	1800
ML	ASSEMBLY BATTEN - MONTAGELATTE - BAGUETTES DE MAINTIEN, NÉCESSAIRES À LA MISE EN PLACE DES PANNEAUX DE TOIT			16	18x90	
TB	FASCIA BOARD - TRAUFBRETT - BANDEAU DE TOIT			8	18x90	1581

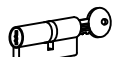
Pos	30.09.2014	ART.NR. 442400	10/11	St.	Profile (mm)	Lenght (mm)
	ROOF ELEMENT - DACHELEMENT - PANNEAU DE TOIT PRÉMONTÉ			8	62x776x2348	
	ROOF ELEMENT - DACHELEMENT - PANNEAU DE TOIT PRÉMONTÉ			8	62x776x2348	
	STORM PROTECTION WIRE CABLES - DRAHTSEILE FÜR STURMSICHERUNG - CABLES MÉTALLIQUE ANTI-TEMPETE			4		6100
	WINDOW HANDLE FITTINGS - FENSTERGRIFF - POIGNÉE D'OUVERTURE DE FENETRE			6		
	SCREW FOR DOOR/WINDOW FILLET - SCHRAUBE ZUR BEFESTIGUNG TÜR- UND FENSTERLEISTE - VIS D'ASSEMBLAGE DU CADRE DE PORTE, FENETRE			14	3x30	
HS3	SCREW FOR ASSEMBLY BATTEN - SCHRAUBEN FÜR MONTAGELATTE - VIS DE FIXATION DES BAGUETTES DE MAINTIEN POUR MISE EN PLACE DU TOIT			4	4x60	
HS1	SCREW FOR FIXING ROOF ELEMENTS - SCHRAUBE FÜR BEFESTIGUNG DACH-ELEMENTEN - VIS DE FIXATION DES PANNEAUX DE TOIT			192	4.5x80	
HS5	SCREW FOR FASCIA BOARDS - SCHRAUBEN FÜR TRAUFBRETTER - VIS DE FIXATION POUR BANDEAU DE TOIT			24	4x40	
HS2	SCREW FOR ASSEMBLY BATTEN (ML) - SCHRAUBEN FÜR MONTAGELATTE (ML) - VIS DE FIXATION DES BAGUETTES DE MAINTIEN POUR MISE EN PLACE DU TOIT (ML)			32	4x40	
	SCREW FOR DOORSTEP - SCHRAUBEN FÜR TÜRSWELLE - VIS DE FIXATION DU SEUIL DE PORTE			3	4.5x65	
	SCREW FOR WALL FINISHING BOARD WF - SCHRAUBE FÜR ABSCHLUSSBOHLE WF VIS D'ASSEMBLAGE DES MADRIERS SUPÉRIEUR DE FINITION WF			32	5x120	
	SCREW FOR 1. WALL BEAM - SCHRAUBE FÜR 1. BOHLENREIHE - VIS DE FIXATION DES FONDATIONS			10	5x90	
	SCREW FOR FUNDAMENT - SCHRAUBEN ZUR BEFISTIGUNG FUNDAMENT VIS POUR FONDATION			12	5x90	
	SCREW FOR DOOR JAMB - SCHRAUBE FÜR TÜRRAHMEN - VIS DE FIXATION POUR MONTANT DE PORTE			4	5x90	
HS4	SCREW FOR FIXING ROOF ELEMENTS WITH WF - SCHRAUBE FÜR BEFESTIGUNG DACHELEMENTEN (WF) - VIS DE FIXATION DES PANNEAUX DE TOIT (WF)			48	5x90	
	ZN NAIL FOR FLOOR FILLET - ZN NÄGEL FÜR FUSSBODENLEISTE - POINTE POUR CORNIERE DE FINITION DU PLANCHER			24	1.4x40	
	HAMMER BLOCK - SCHLAGHOLZ - CALLE DE FRAPPE			1		

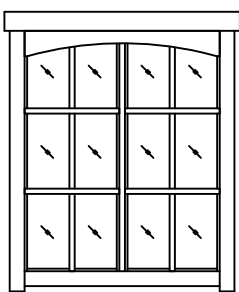
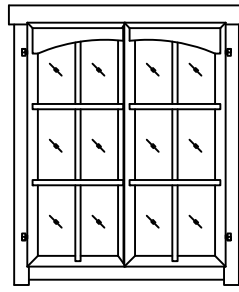
Pos	30.09.2014	ART.NR. 442400	11/11	St.	Profile (mm)	Lenght (mm)
	BOLT FOR WINDOW HANDLE FITTINGS - BOLZEN FÜR FENSTERGRIFF BESCHLAG - BOULON POUR POIGNÉE D'OUVERTURE DE FENETRE			12		
	SCREW-EYELETS FOR STORM PROTECTION - SCHRAUBÖSEN FÜR STURMSICHERUNG - - OEILLETS DE VISSAGE POUR LAME ANTI-TEMPETE			8		
	CLAMPS FOR STORM PROTECTION - KLEMMEN FÜR STURMSICHERUNG - COLLIER POUR LAME ANTI-TEMPETE			16		
	TURNBUCKLES FOR STORM PROTECTION - SPANNSCHLÖSSER FÜR STURMSICHERUNG - - TENDEUR A VIS POUR LAME ANTI-TEMPETE			4		
	SET OF DOOR LOCK COVERS - SCHLOSSBLENDEN - SET DE GARNITURES DE SERRURE DE PORTE			1		
	MALE BOLT HINGE FOR DOOR - TÜRRIEGEL - PARTIE MALE DE CHARNIERE DE PORTE			6		
	DOOR HANDLE FITTINGS - TÜRGRIFF - SET DE GARNITURES DE SERRURE DE PORTE			1		
	CYLINDER - ZYLINDERSCHLOSS - CYLINDRE DE SERRURE			1		
	SCREW FOR GEORGIAN BARS - SCHRAUBE FÜR SPROSSEN - VIS DE BARRES GEORGIENNE			152	2.5x20	
	WINDOW-FENSTER - FENETRE 996x1210 SGC		TAK.1.106.SM0.Ke	4		
						
	WINDOW - FENSTER - FENETRE 996x1210 SGC		TAK.1.106.SVP.Ke	3		
						
	DOOR-TÜR - PORTE 996x1850 SGC		TUK.2.066.SVP.MMKd	1		
	