

*Barbados 4*  
*Art. Nr. 446602*  
*1/9*



28.11.2013

Art.Nr. 446602

GROUNDPLAN - GRUNDPLAN - PLAN DE MASSE

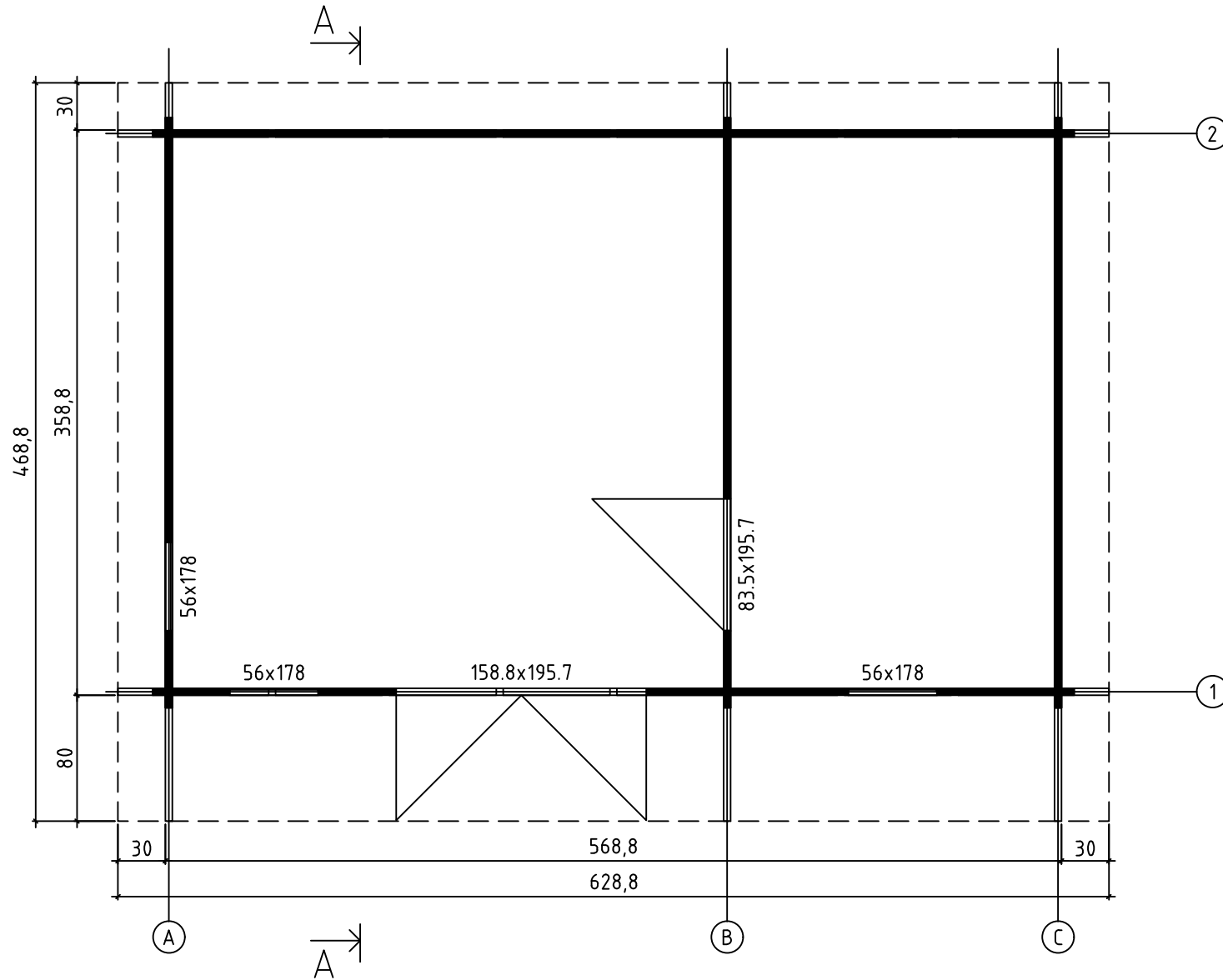

FOUNDATION - FUNDAMENT - FONDATION

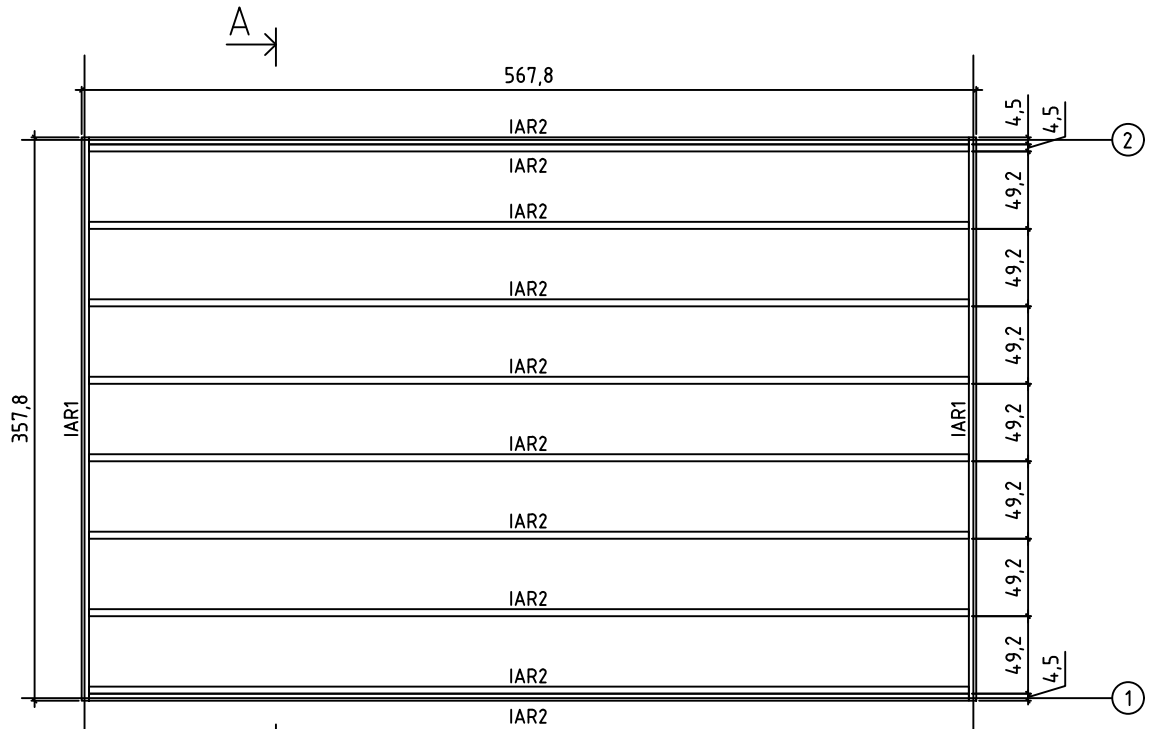



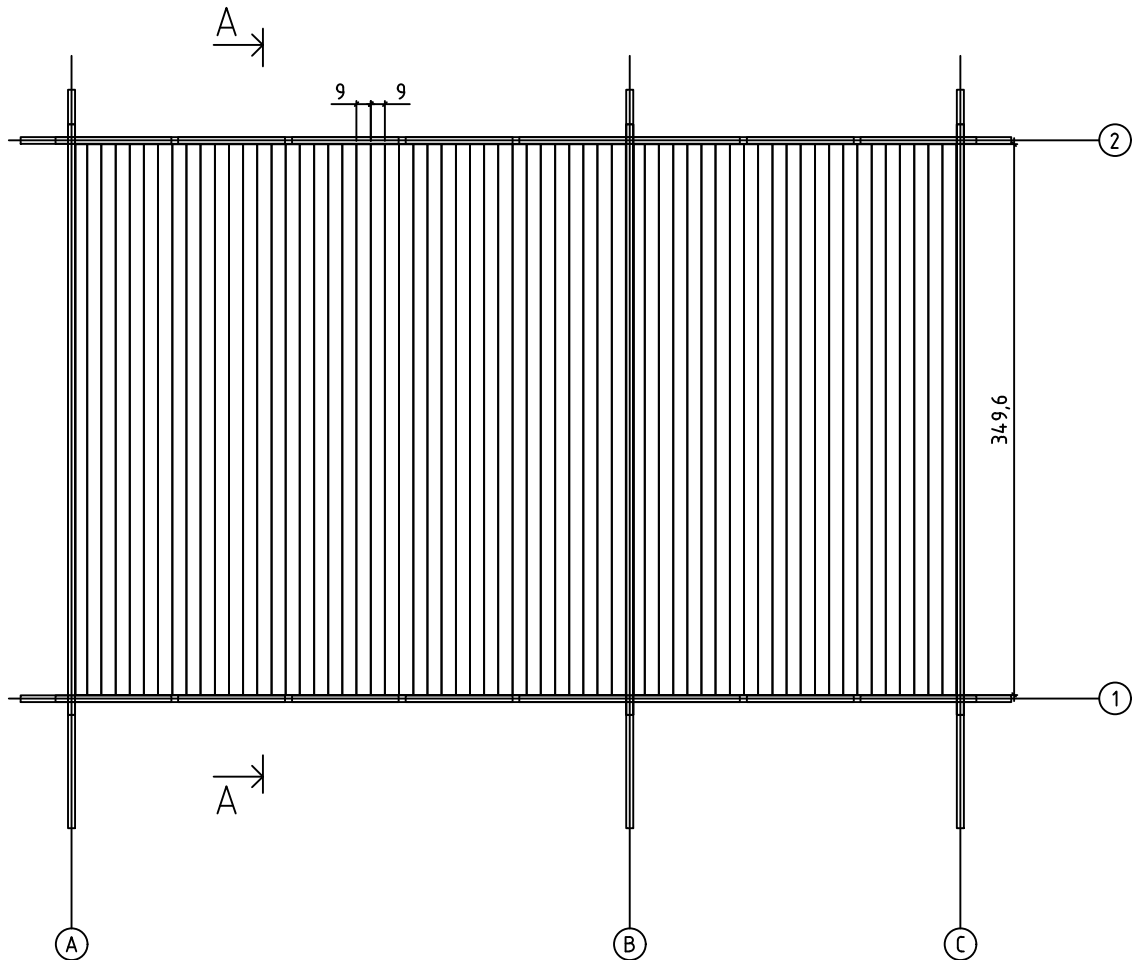

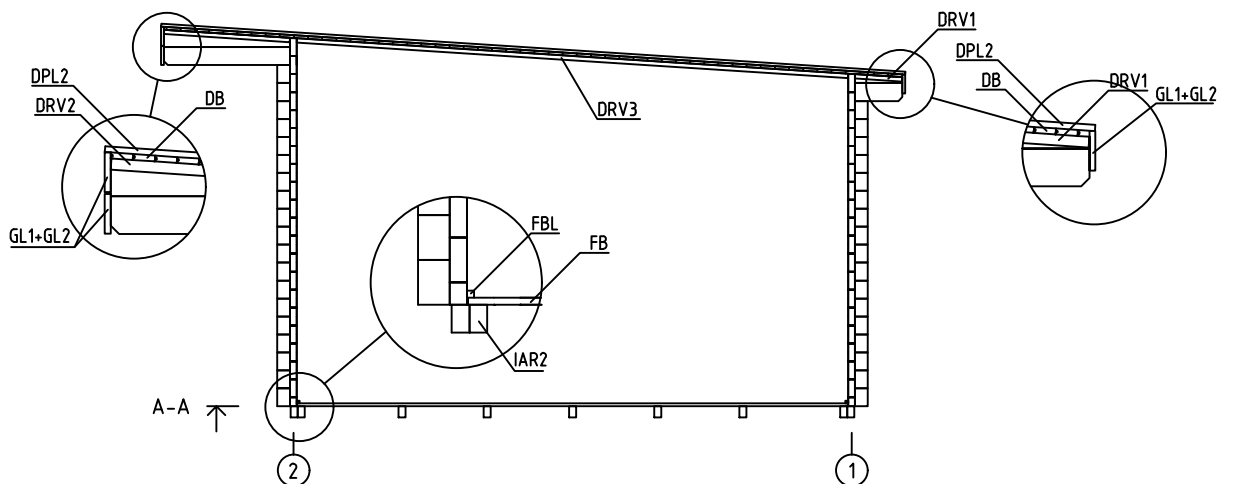
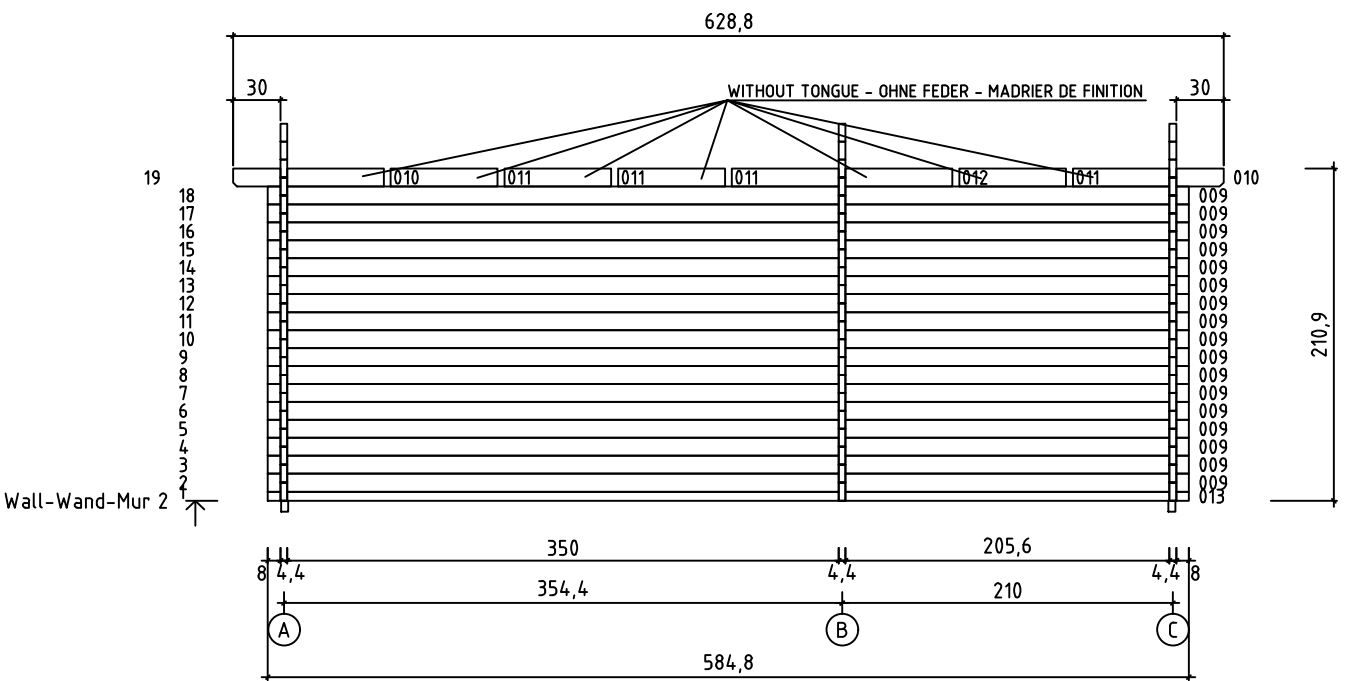
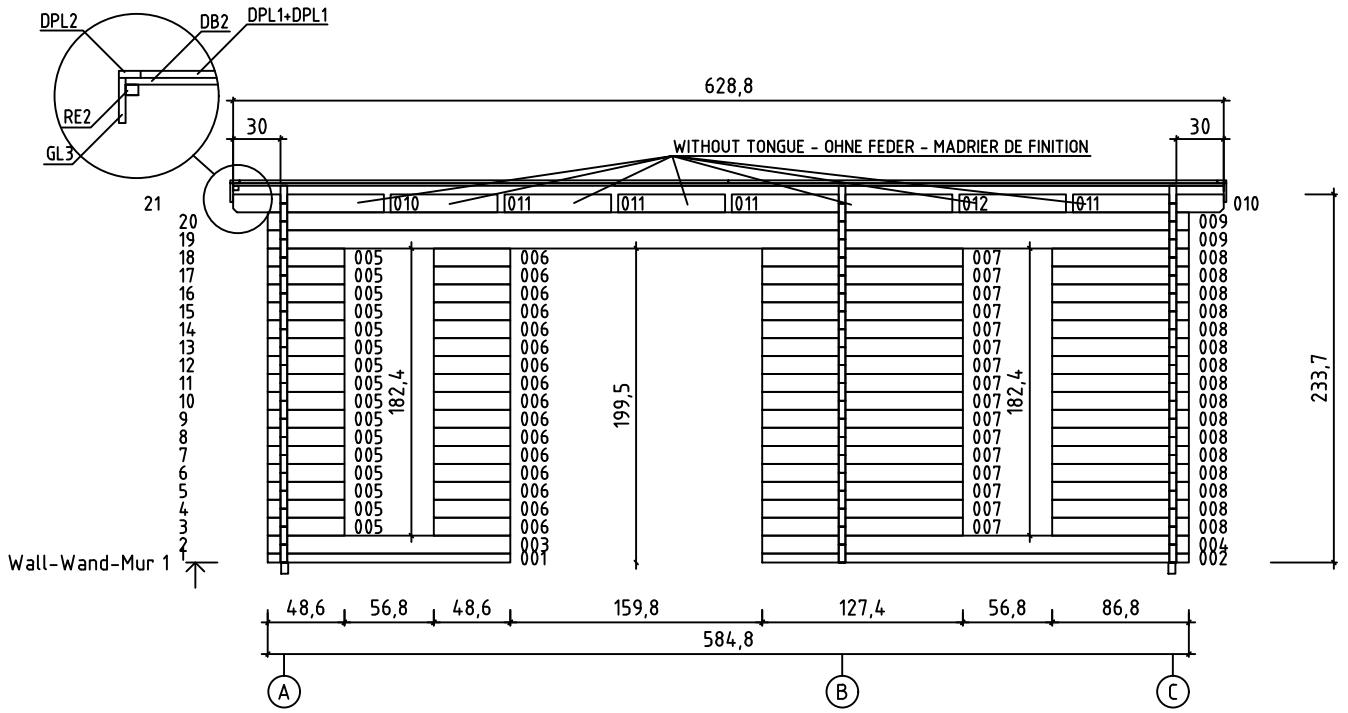

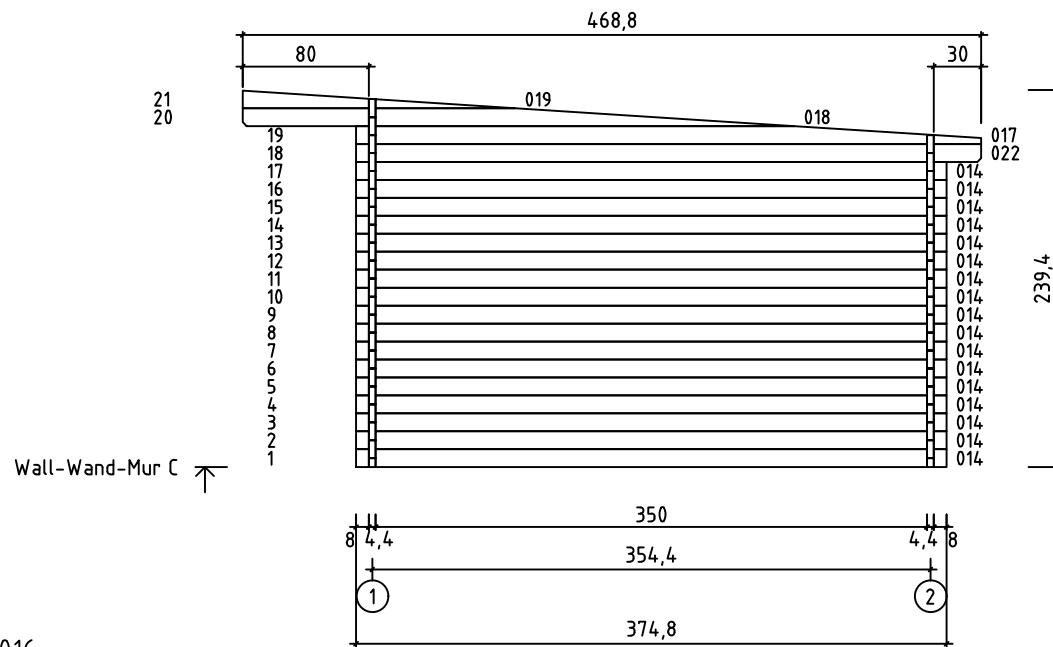
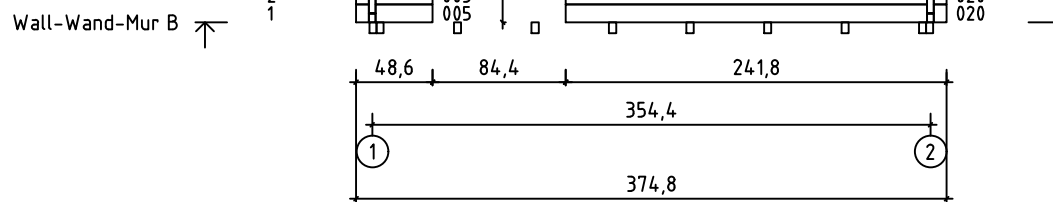
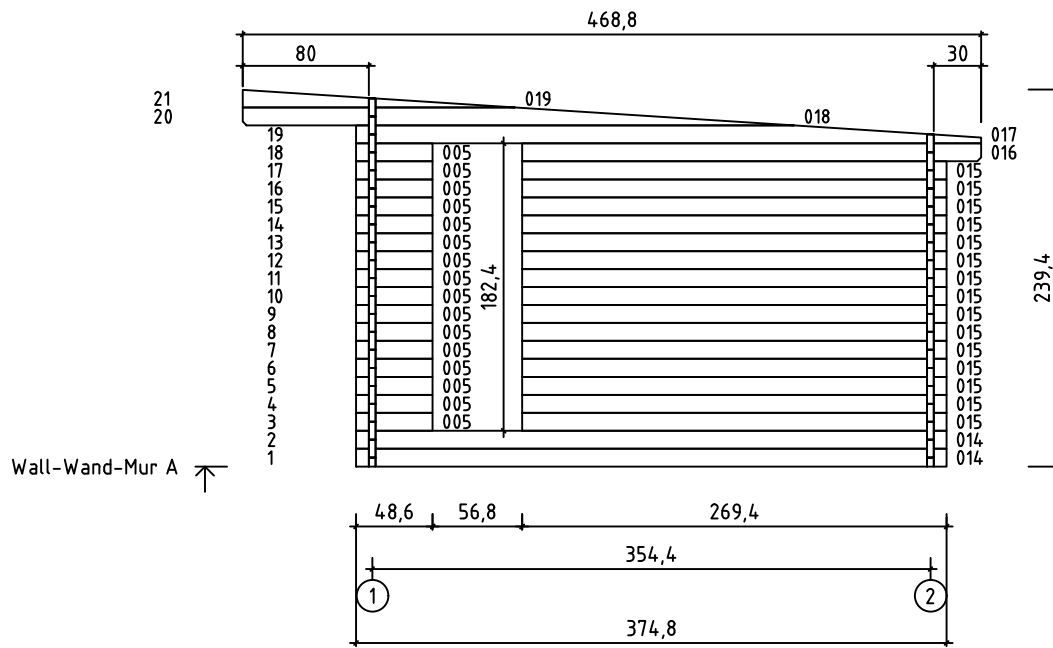

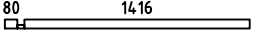
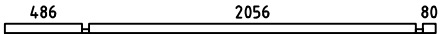
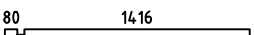
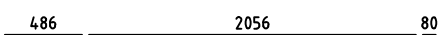

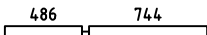
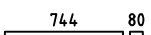

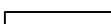

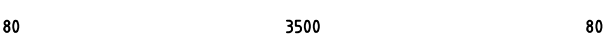
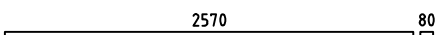
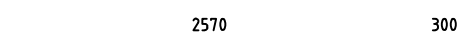
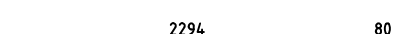
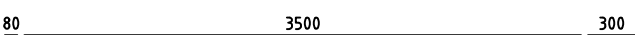
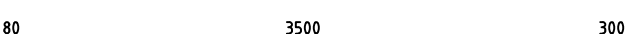
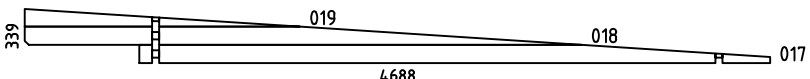
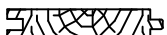









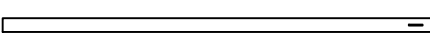
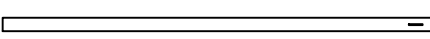

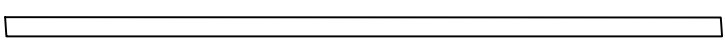
FLOOR BOARDS - FUSSBODENBRETTER - PLAN POSE PLANCHER









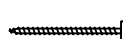
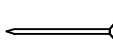

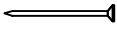
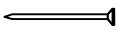
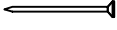
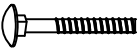

Pos	27.05.2016	Piecelist - Stücklist - Liste des composants Art.Nr. 446602	6/9	Q.	P. (mm)	L. (mm)
001				1	44x57	1540
002				1	44x57	2710
003				1	44x114	1540
004				1	44x114	2710
005				49	44x114	486
006				16	44x114	486
007				16	44x114	1274
008				16	44x114	868
009				19	44x114	5848
010				4	44x114	956
011				8	44x114	678
012				2	44x114	1400
013				1	44x57	5848
014				19	44x114	3748
015				15	44x114	2694
016				1	44x114	2914
020				17	44x114	2418
021				1	44x114	3968
022				1	44x114	3968
WA-1 WB-1 WC-1				1 1 1		
IAR2	FOUNDATION - FUNDAMENT - FONDATION			10	45x70	5588
IAR1	FOUNDATION - FUNDAMENT - FONDATION			2	45x70	3578
SR1	RAFTER - DACHSPARREN - CHEVRON			6	44x140	4707
FB	FLOOR BOARDS - FUSSBODENBRETT - LAME DE PLANCHER			62	90x18	3496

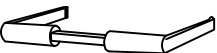
Pos	27.05.2016	Piecelist - Stücklist - Liste des composants Art.Nr. 446602	7/9	Q.	P. (mm)	L. (mm)
DB1		ROOF BOARDS - DACHBRETTER - VOLIGES		53	90x18	3866
DB2		ROOF BOARDS - DACHBRETTER - VOLIGES		53	90x18	2422
FBL		FLOOR FILLET-FUSSBODENLEISTE - CORNIERE DE FINITION DU PLANCHER			18x18	25.08
DPL1		ROOFING FELT FILLET - DACHPAPPENLEISTE - BAGUETTE DE FIXATION DU FEUTRE BITUMEUX		2	18x58	3104
DPL2		ROOFING FELT FILLET - DACHPAPPENLEISTE - BAGUETTE DE FIXATION DU FEUTRE BITUMEUX		2	18x58	4734
DRV1		ROOF EDGE REINFORCEMENT - DACHRANDVERSTÄRKUNG - CORNIERE DE RENFORT DE BORD DE TOIT		2	28x34	299
DRV2		ROOF EDGE REINFORCEMENT - DACHRANDVERSTÄRKUNG - CORNIERE DE RENFORT DE BORD DE TOIT		2	28x34	800
DRV3		ROOF EDGE REINFORCEMENT - DACHRANDVERSTÄRKUNG - CORNIERE DE RENFORT DE BORD DE TOIT		2	28x34	3505
KFS-1		STORM PROTECTION - STURMLEISTE - - LATTE ANTI-TEMPETE		2	22x45	2050
KFS-2		STORM PROTECTION - STURMLEISTE - - LATTE ANTI-TEMPETE		2	22x45	2500
GL1		GABLE MOULDING - GIEBELLEISTE - - PLANCHE DE RIVE		3	18x120	2440
GL2		GABLE MOULDING - GIEBELLEISTE - - PLANCHE DE RIVE		3	18x120	3884
GL3		GABLE MOULDING - - GIEBELLEISTE - - PLANCHE DE RIVE		2	18x120	4705
FS2		WINDOW HANDLE FITTINGS - FENSTERGRIFF - POIGNÉE D'OUVERTURE DE FENETRE		3	FG10.AL	
HS9		SCREW FOR GABLE MOULDING - SCHRAUBEN FÜR GIEBELLEISTE - VIS DE FIXATION POUR PLANCHE DE RIVE		86	3.5x50	
HS4		SCREW FOR DOOR FILLET - SCHRAUBE ZUR BEFESTIGUNG TÜRLEISTE - VIS D'ASSEMBLAGE DU CADRE DE PORTE		5	3x30	
HS12		SCREW FOR ROOF EDGE REINFORCEMENT - SCHRAUBEN FÜR DACHRANDVERSTÄRKUNG - VIS POUR RENFORT DE BORD DE TOIT		26	4x40	
HS18		SCREW FOR ROOF BEAMS - SCHRAUBEN FÜR DACHBALKEN - VIS POUR PANNE DE TOIT		18	5x120	
HS18		SCREW FOR GABLE - SCHRAUBEN FÜR GIEBEL - VIS POUR FIXATION DES PIGNONS		9	5x120	
HS16		SCREW FOR 1. WALL BEAM - SCHRAUBE FÜR 1. BOHLENREIHE - VIS DE FIXATION DES FONDATIONS		8	5x90	
HS16		SCREW FOR FUNDAMENT - SCHRAUBEN ZUR BEFESTIGUNG FUNDAMENT - VIS POUR FONDATION		28	5x90	
HS16		SCREW FOR DOOR JAMB - SCHRAUBE FÜR TÜRRAHMEN - VIS DE FIXATION POUR MONTANT DE PORTE		4	5x90	
HS23		SCREW FOR POS 010-012 - SCHRAUBEN FÜR für POS 010-012 - VIS POUR FIXATION DERNIÈRE RANGÉE MADRIERS (MURS AVANT ET ARRIÈRE)		16	6x180	
HS25		SCREW FOR DOORSTEP - SCHRAUBEN FÜR SWELLE - VIS DE FIXATION DU SEUIL DE PORTE		3	4.5x65	
NF2		ZN NAIL FOR FLOOR FILLET - ZN NÄGEL FÜR FUSSBODENLEISTE - POINTE POUR CORNIERE DE FINITION DU PLANCHER		58	1.4x40	

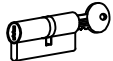
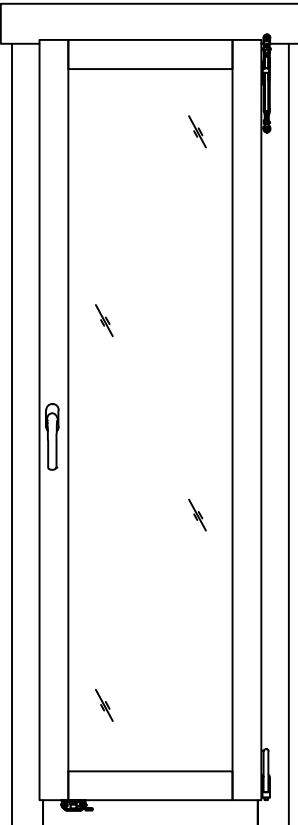
Pos	27.05.2016	Piecelist - Stücklist - Liste des composants Art.Nr. 446602	8/9	Q.	P. (mm)	L. (mm)
SH44	HAMMER BLOCK - SCHLAGHOLZ - CALLE DE FRAPPE			1		
SFS	NUT FOR STORM PROTECTION - SCHRAUBENMUTTER FÜR STURMLEISTE - ÉCROU POUR LAME ANTI-TEMPETE			8	D8	
NF4	ZN NAIL FOR ROOF - ZN NÄGEL FÜR DACHBRETTER - POINTES DE FIXATIONS DES VOLIGES DE TOIT			540	2x50	
NF4	ZN NAIL FOR FLOOR - ZN NÄGEL FÜR FUSSBODENBRETTER - CLOUS POUR PLANCHER			512	2x50	
NF5	ZN NAIL FOR ROOFING FELT FILLET - ZN NÄGEL FÜR DACHPAPPENLEISTE - POINTE POUR BAGUETTE FIXATION FEUTRE BITUMEUX			38	2x40	
BFS	BOLT FOR STORM PROTECTION - BOLZEN FÜR STURMLEISTE - VIS POUR LAME ANTI-TEMPETE			8	8x80	
	MALE BOLT HINGE FOR DOOR - TÜRRIEGEL - PARTIE MALE DE CHARNIERE DE PORTE			6	14x80	
DFS	WASHER FOR STORM PROTECTION - DICHTSCHEIBE FÜR STURMLEISTE - RONDELLE POUR LAME ANTI-TEMPETE			8	D8	
TL4	DOOR HANDLE FITTINGS - TÜRGRIF - SET DE GARNITURES DE SERRURE DE PORTE			2		
TL5	SET OF DOOR LOCK COVERS - SCHLOSSBLENDEN - SET DE GARNITURES DE SERRURE DE PORTE			2		
	CYLINDER LOCK - ZYLINDERSCHLOSS - CYLINDRE DE SERRURE			2	30x35	
	WINDOW - FENSTER - FENETRE 560x1780 DGP+		AK.1.100.PSP	3		
						

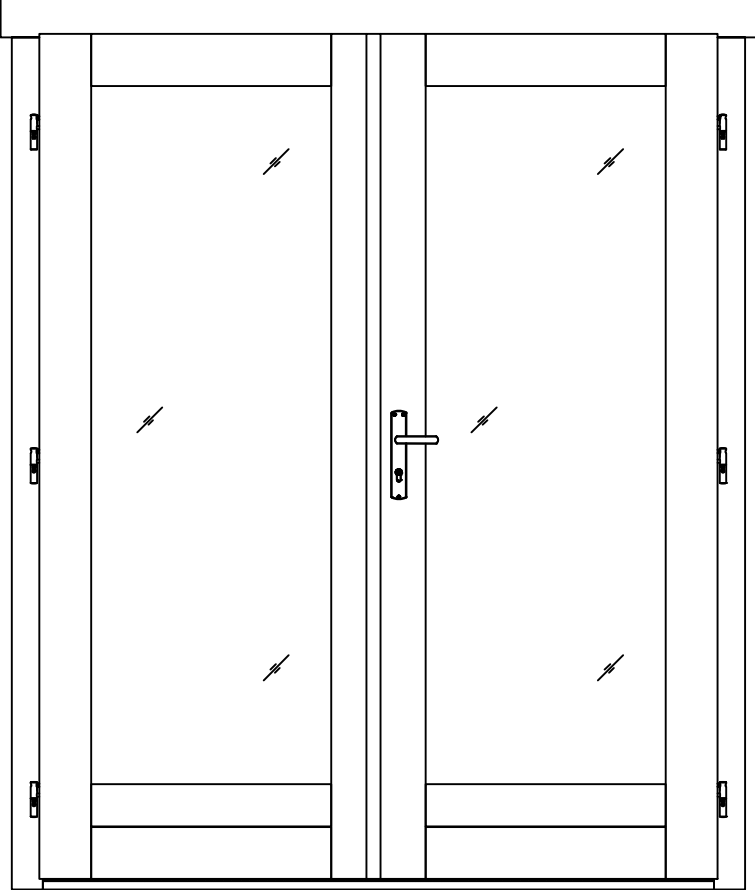
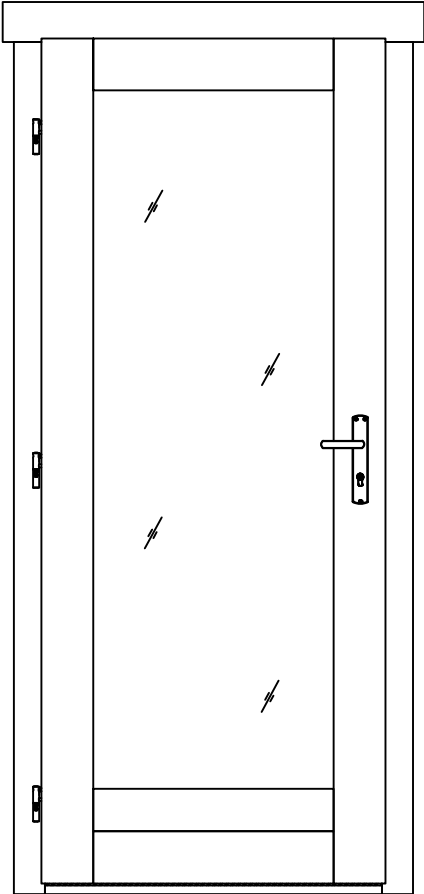

Pos	27.05.2016 Piecelist - Stücklist - Liste des composants Art.Nr. 446602	9/9	Q.	P. (mm)	L. (mm)
	<p>DOOR - TÜR - PORTE 1588x1957 DGP+ <span style="float: right;">TUK.1.100.PVP.MM</span></p> 	1			
	<p>DOOR - TÜR - PORTE 835x1957 DGP+ <span style="float: right;">UK.1.100.PVV.MM</span></p> 	1			