

Ganges
Art.No. 702244

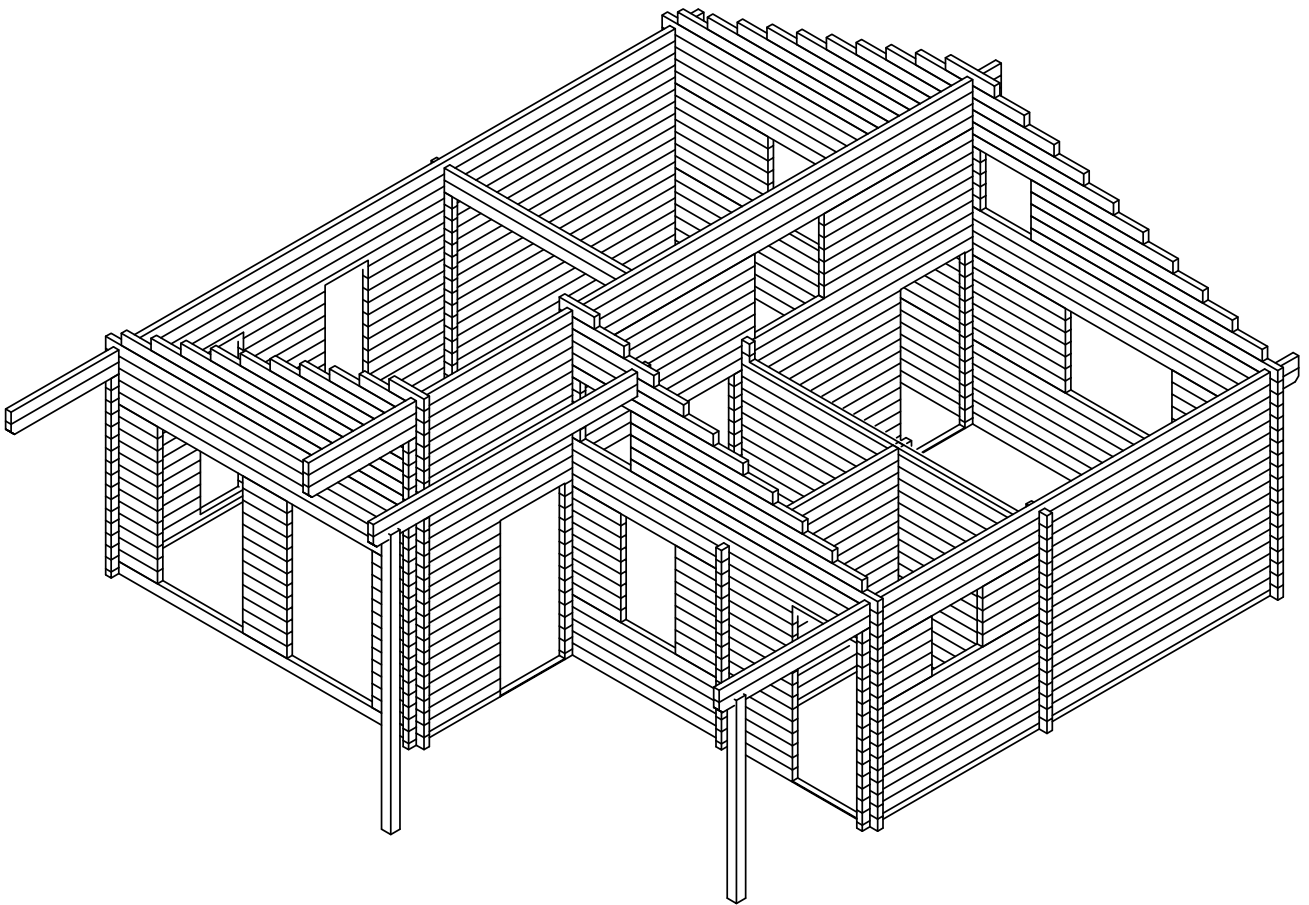

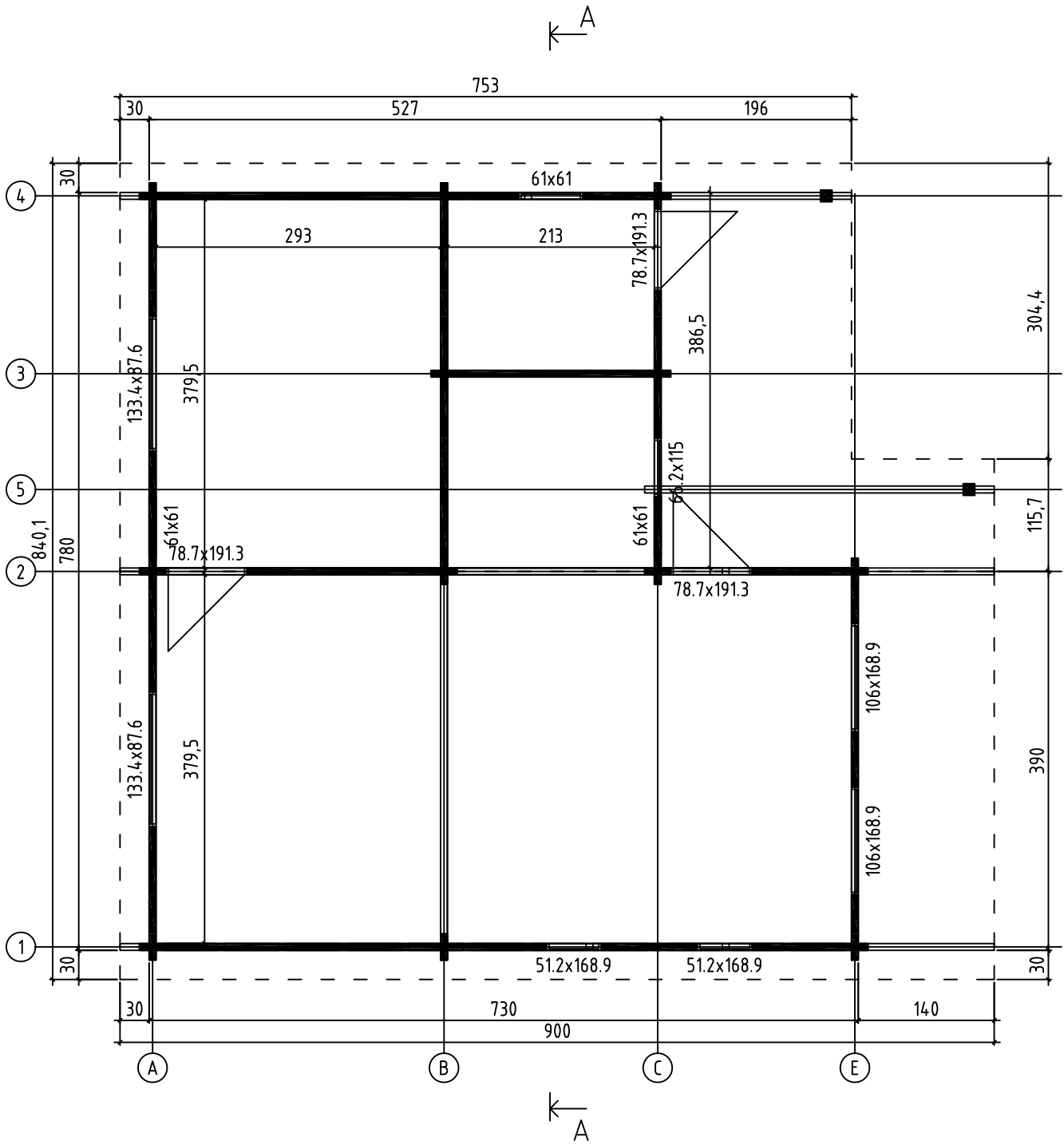

GANGES, Art.No.702244
GROUNDPLAN FIRST FLOOR - GRUNDPLAN ERSTE STOCK - PLAN DE MASSE PREMIER ETAGE

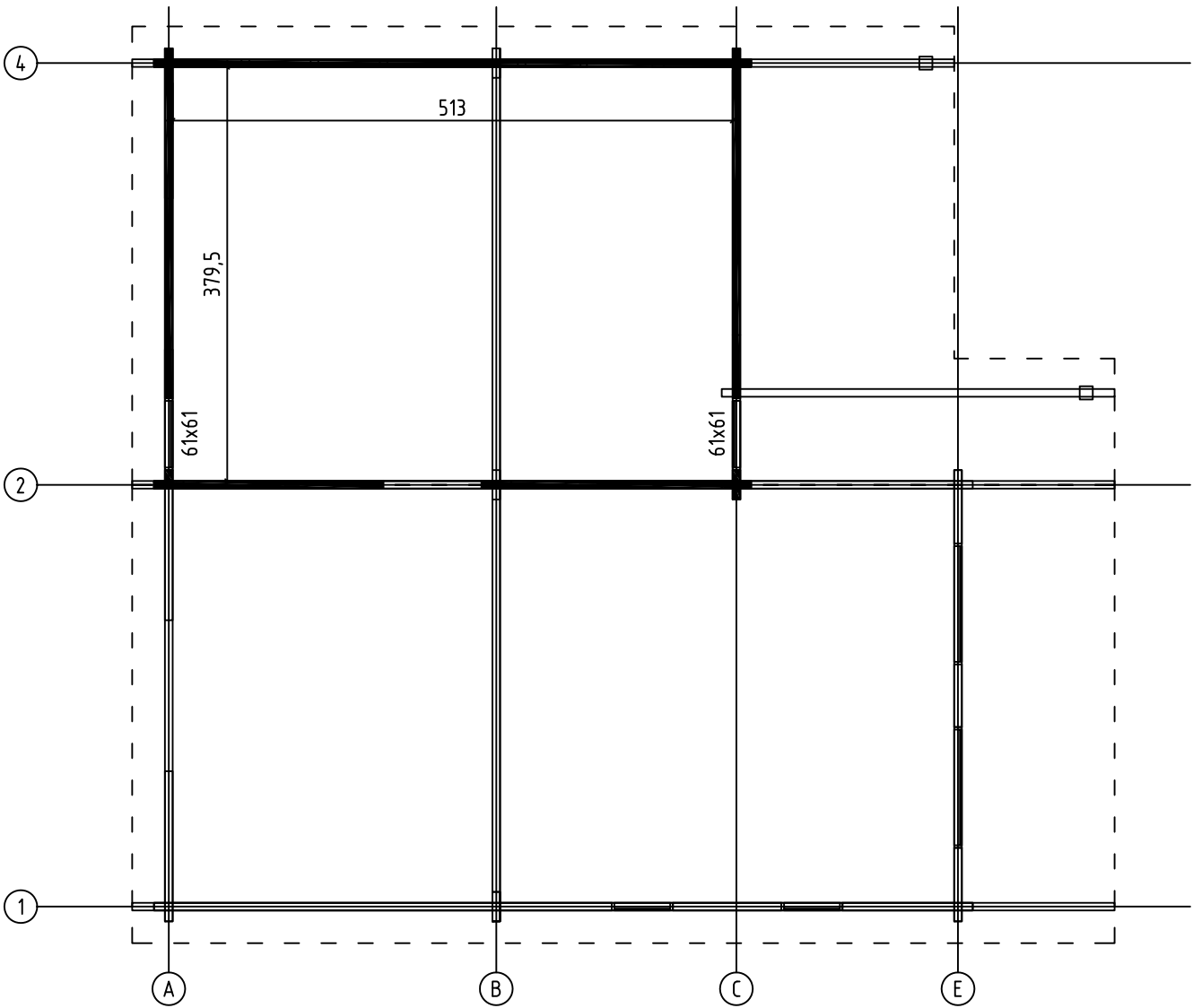

GANGES, Art.No.702244
FOUNDATION - FUNDAMENTBALKEN - FONDATION

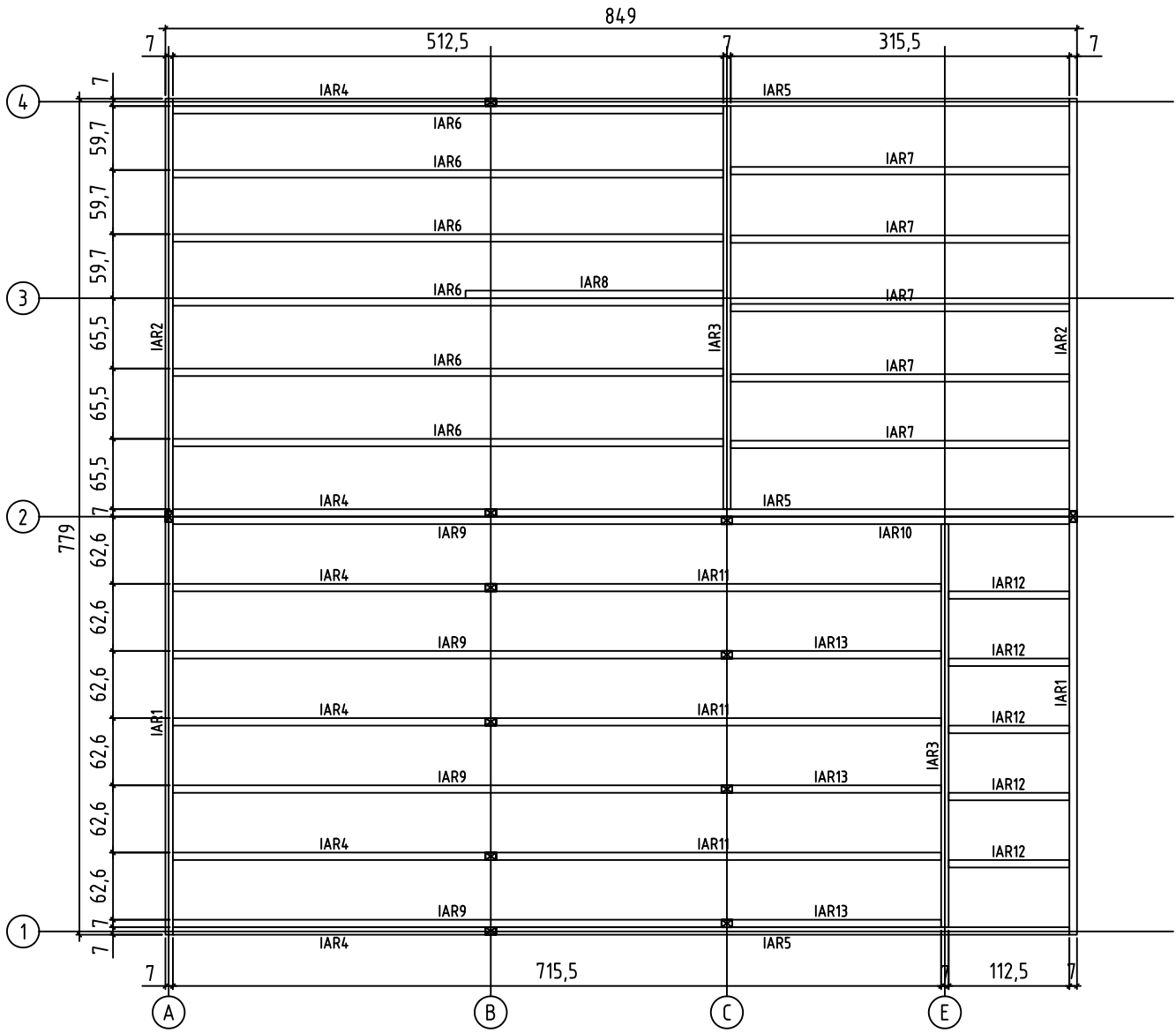

GANGES, Art.No.702244
 RAFTERS PLAN - DACHSPARREN - PLAN DE CHEVRON

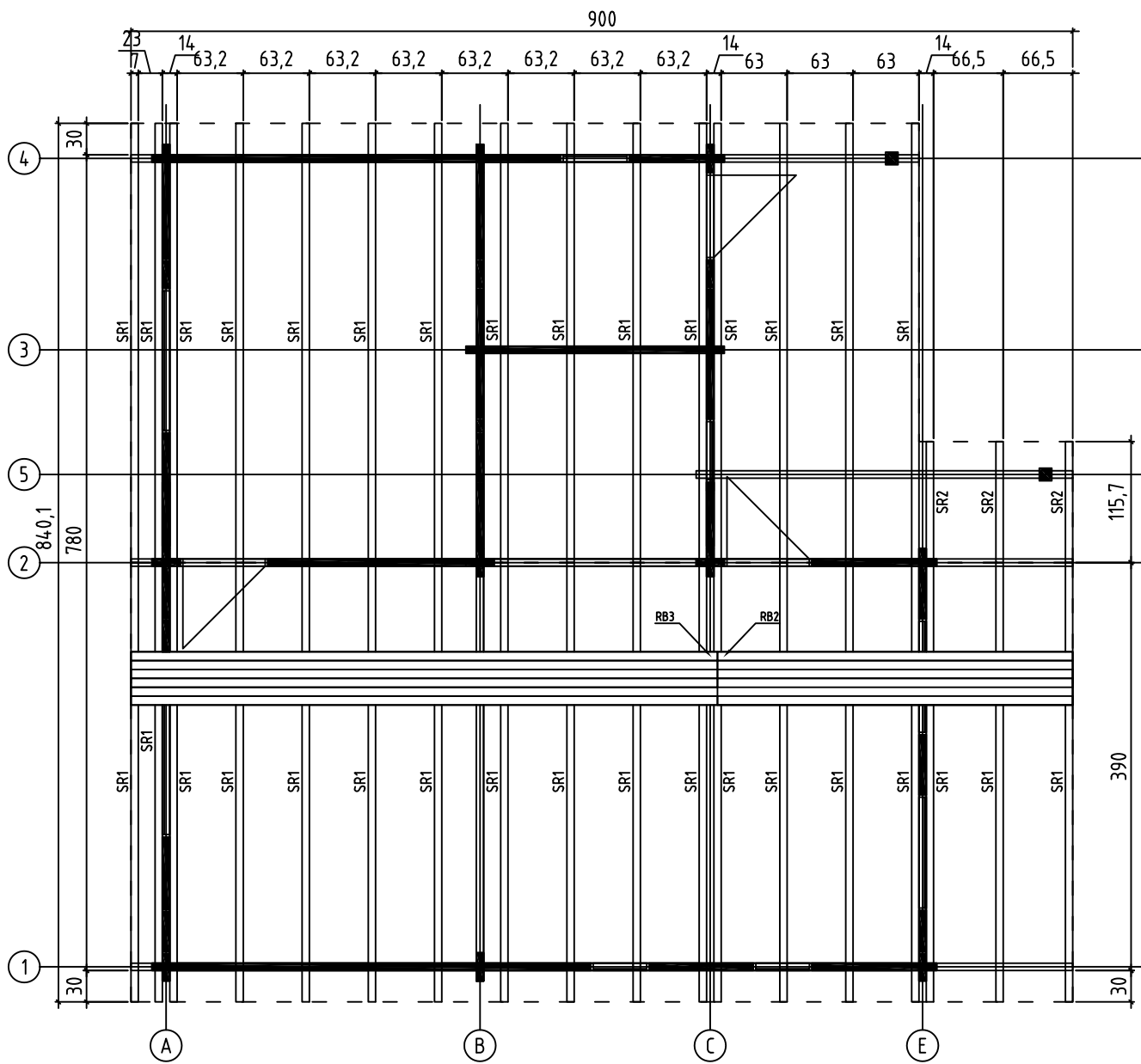

GANGES, Art.No.702244
 MEZZANINE FLOOR JOISTS - HALBGESCHOSS BALKEN - SOLIVES DE PLANCHER MEZZANINE

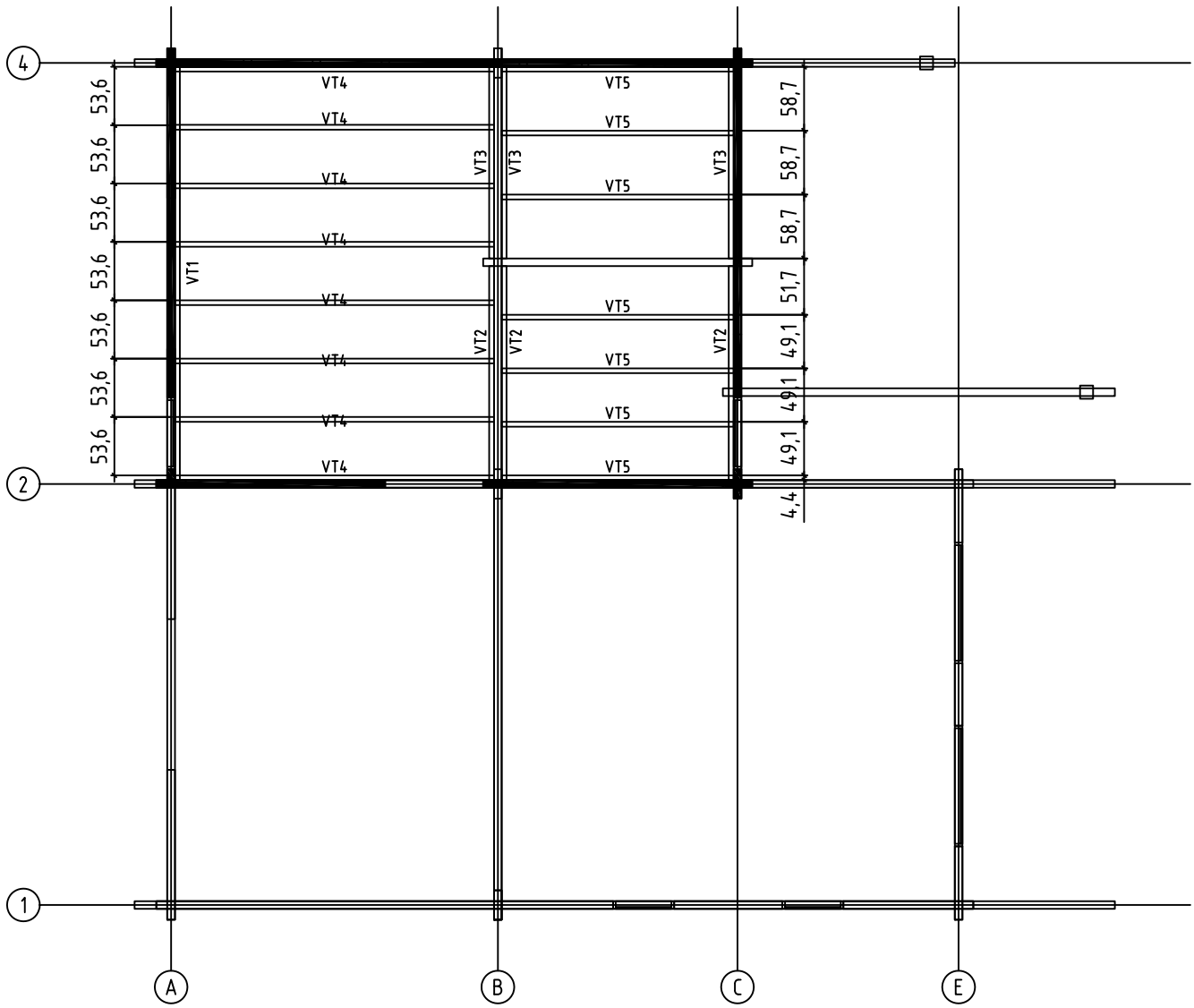

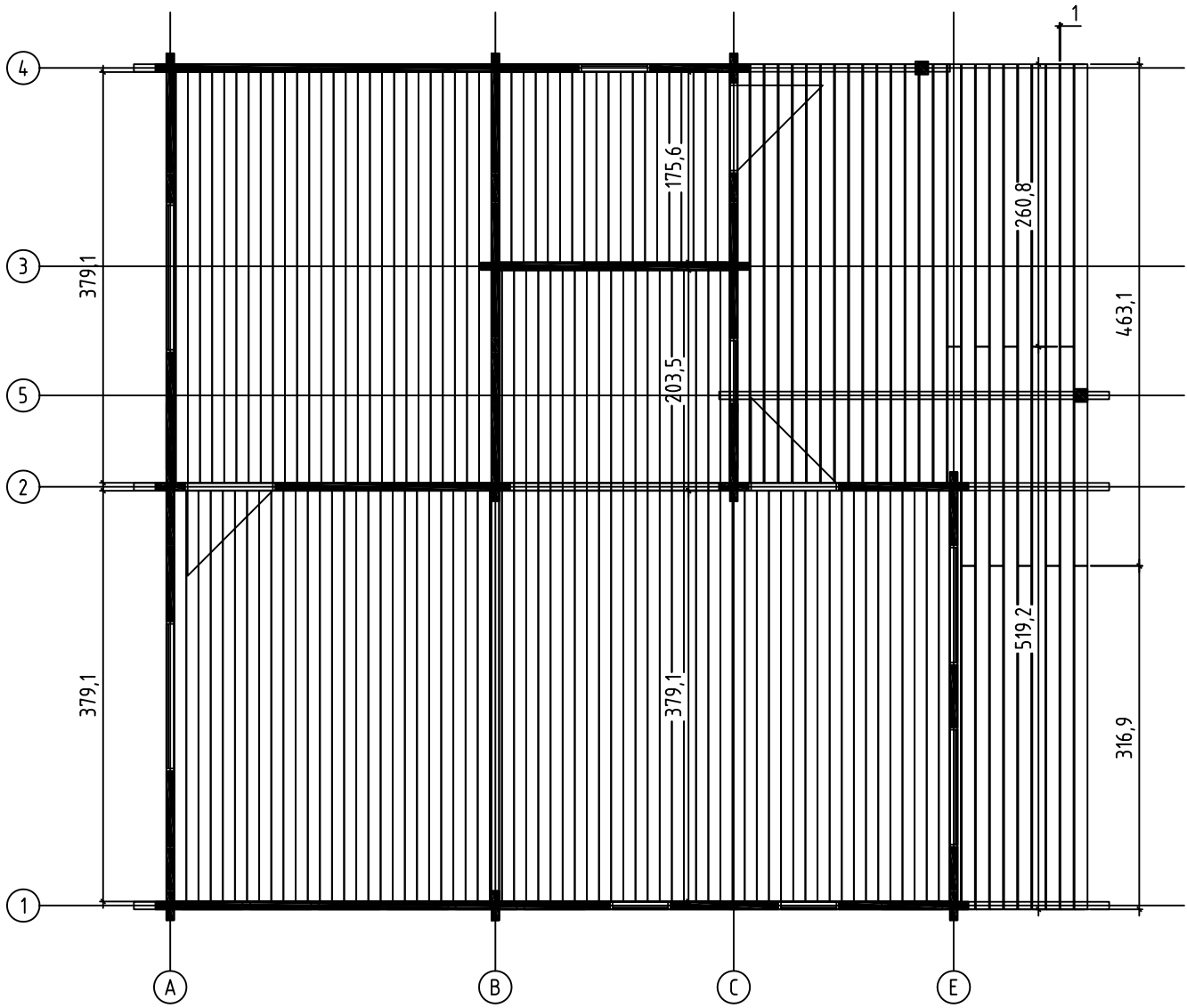

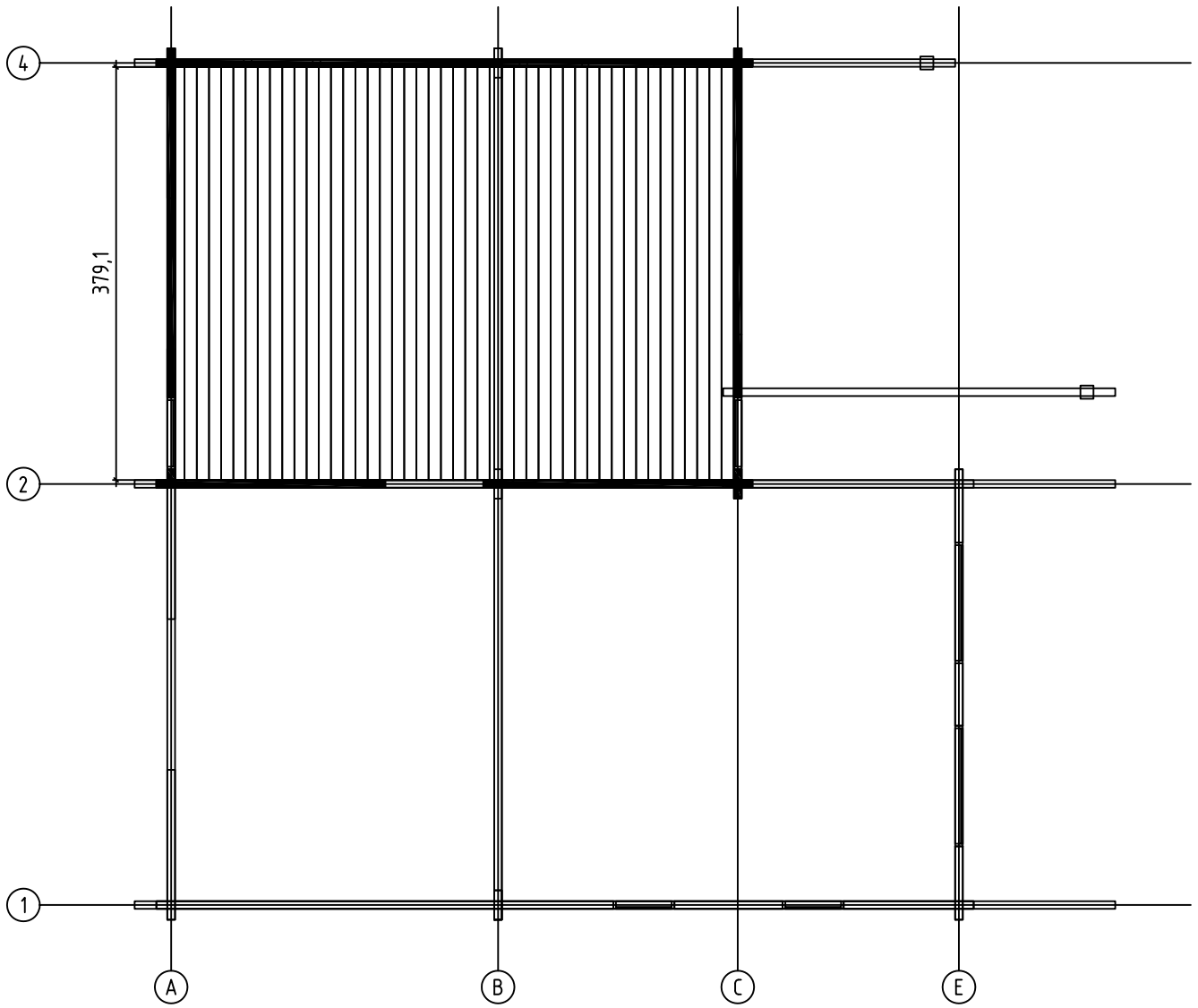

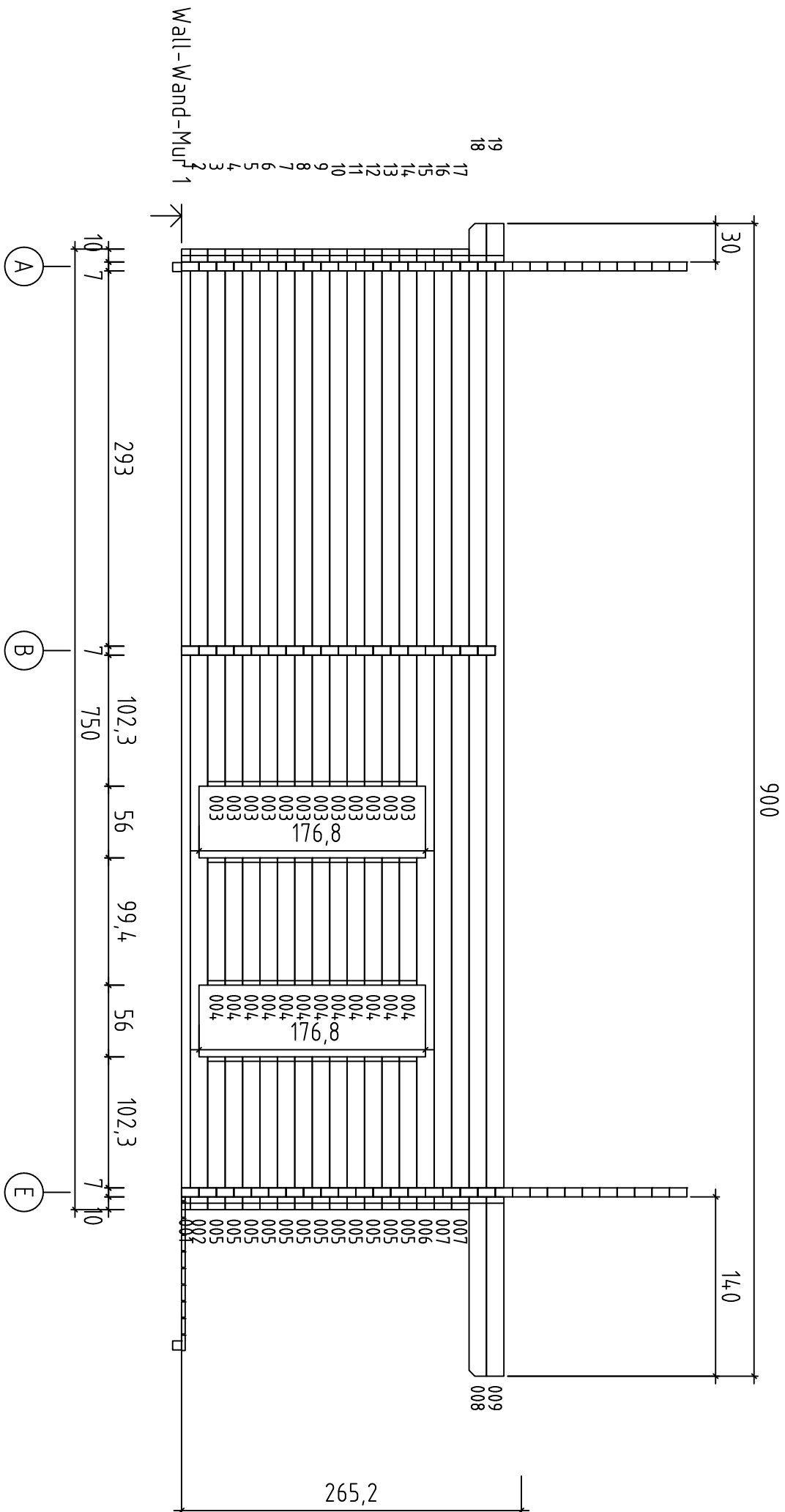

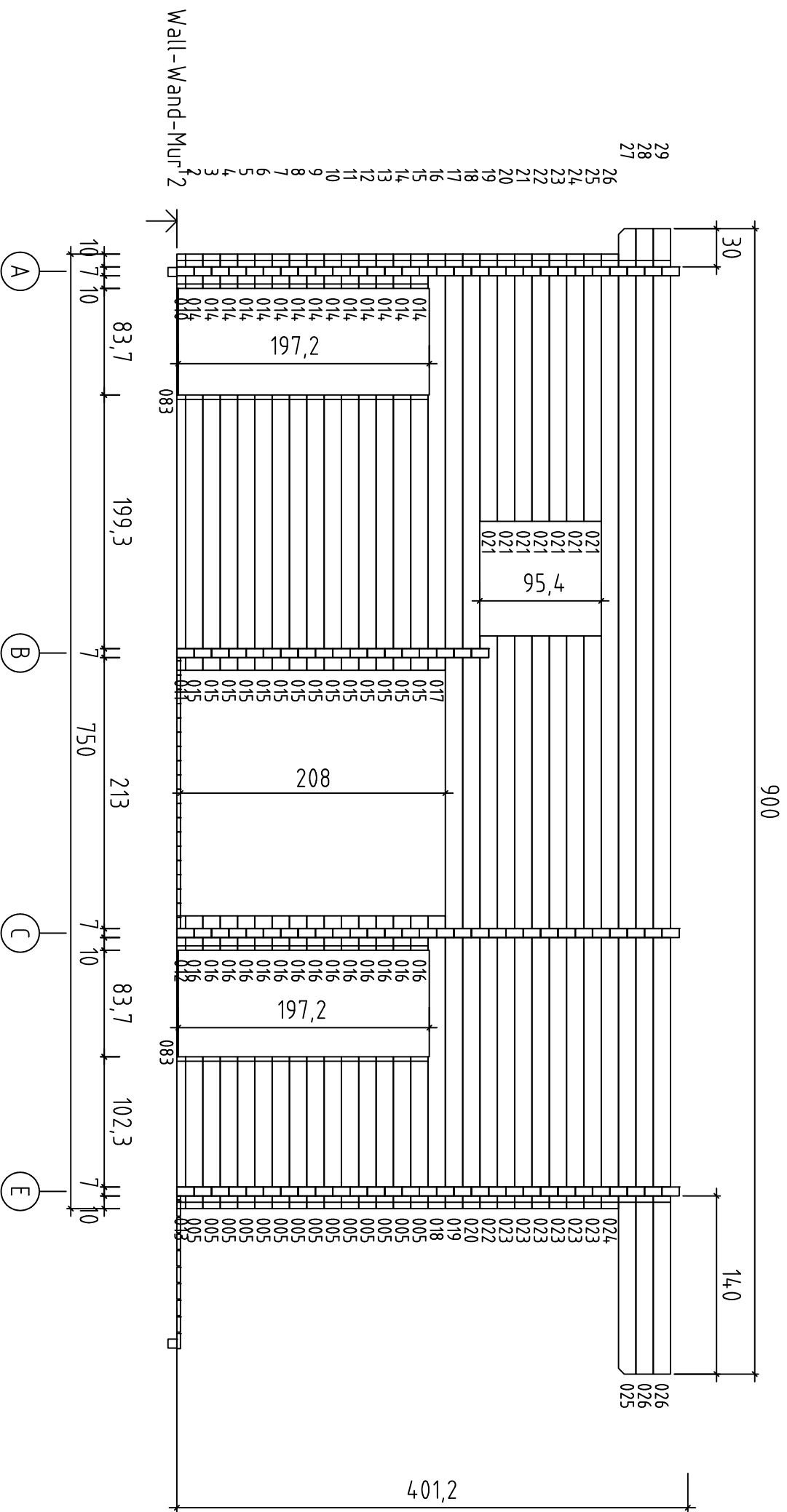

Wall - Wand - Mur 2

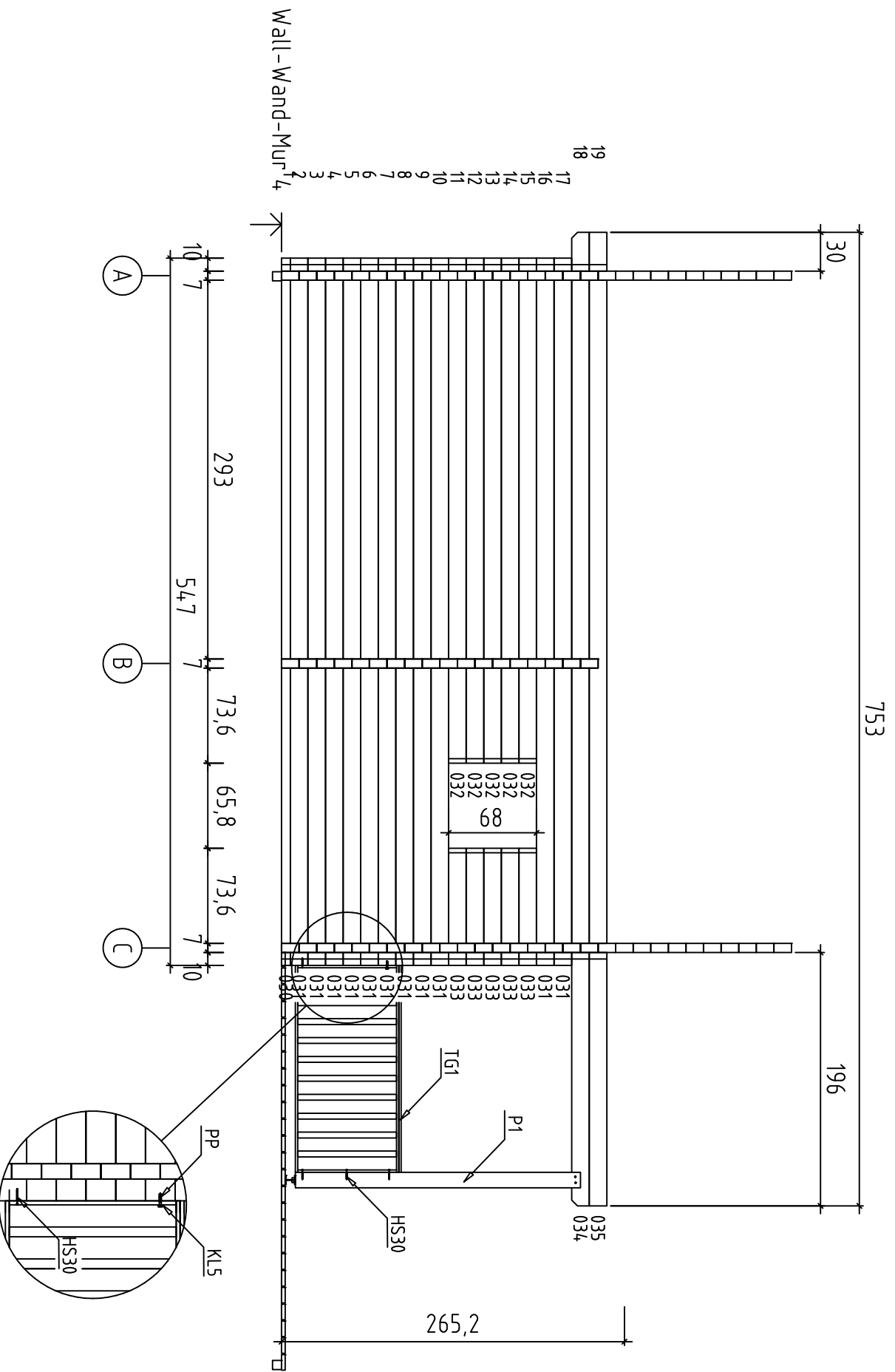

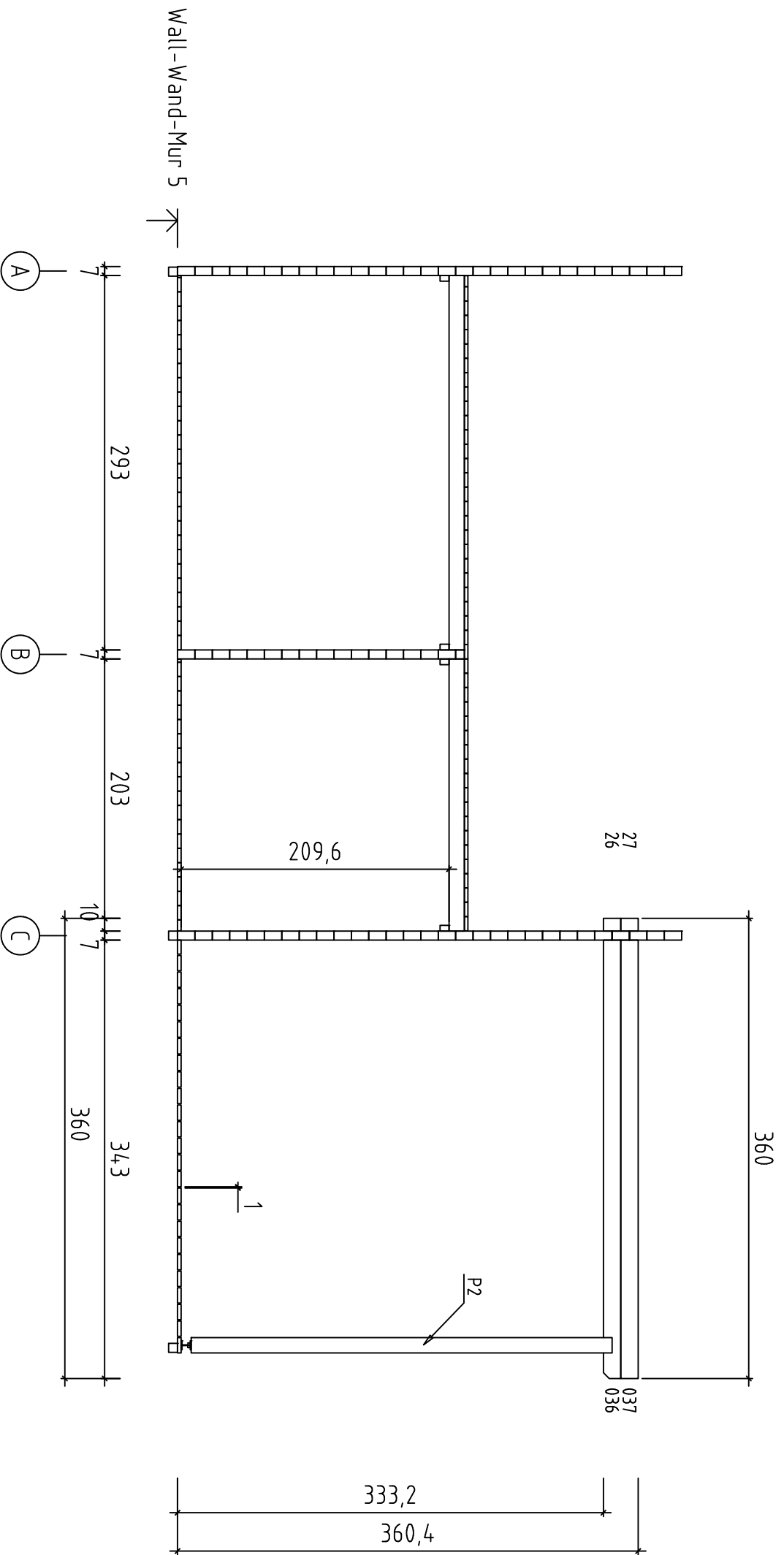

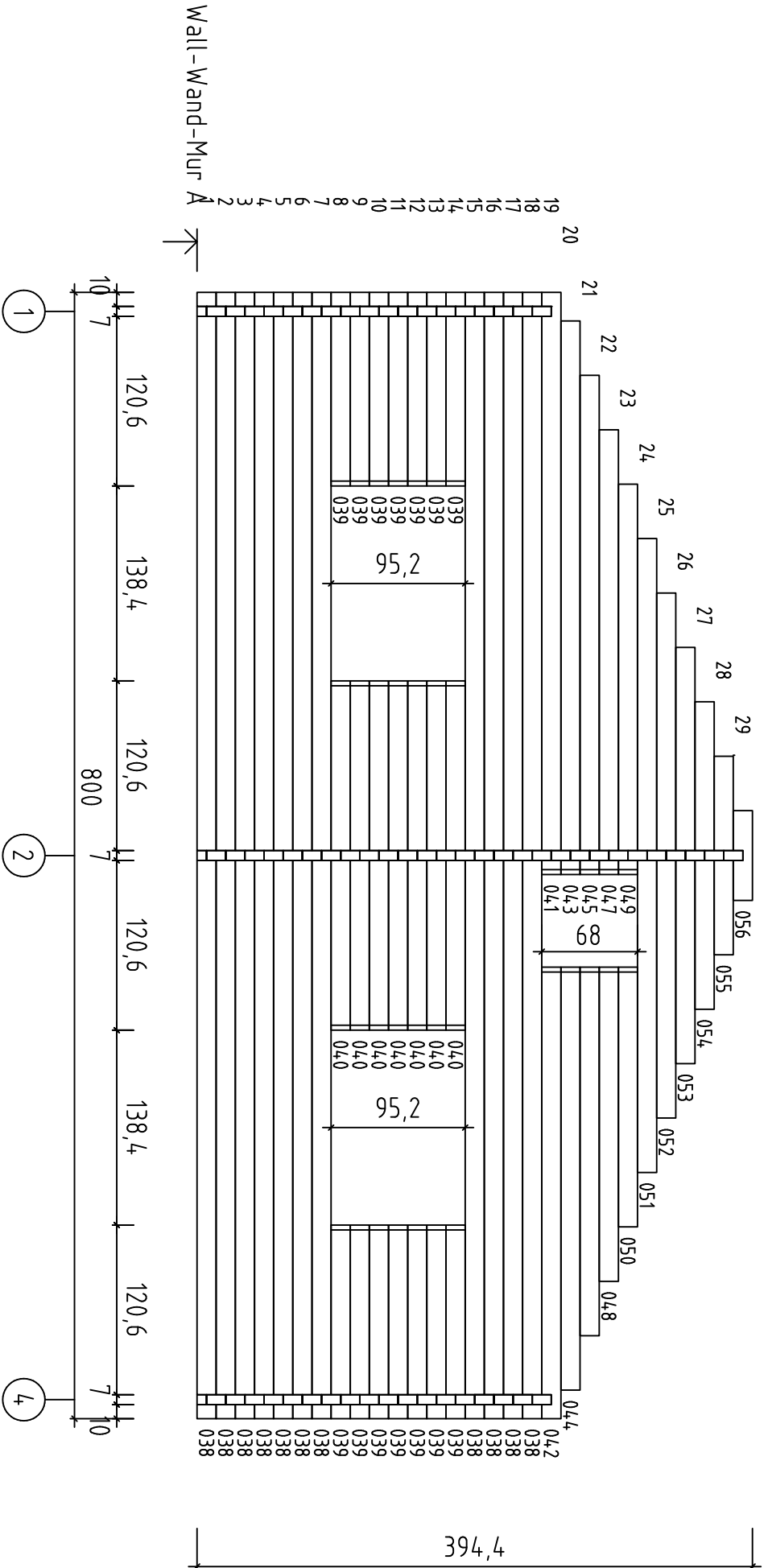

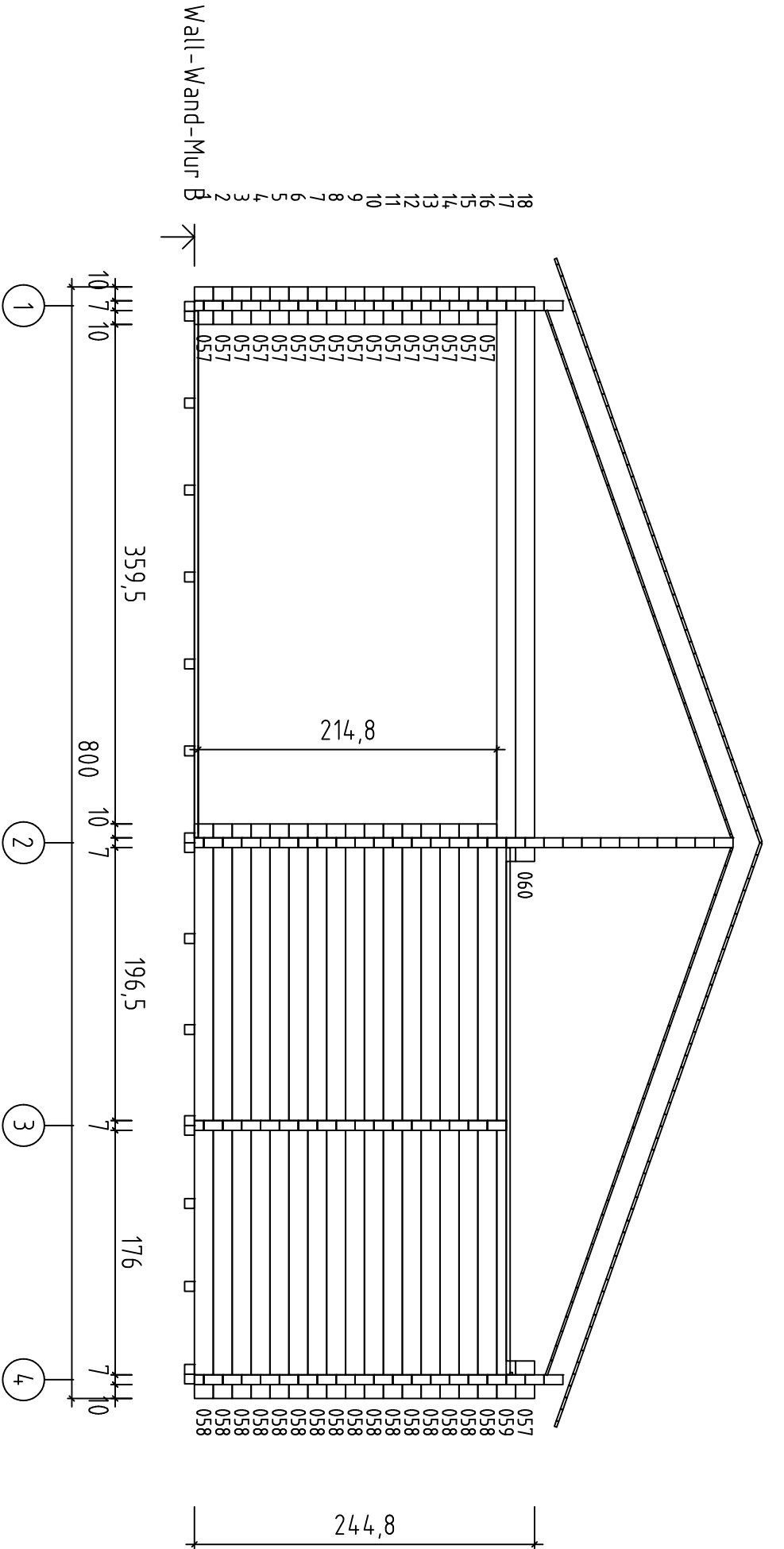

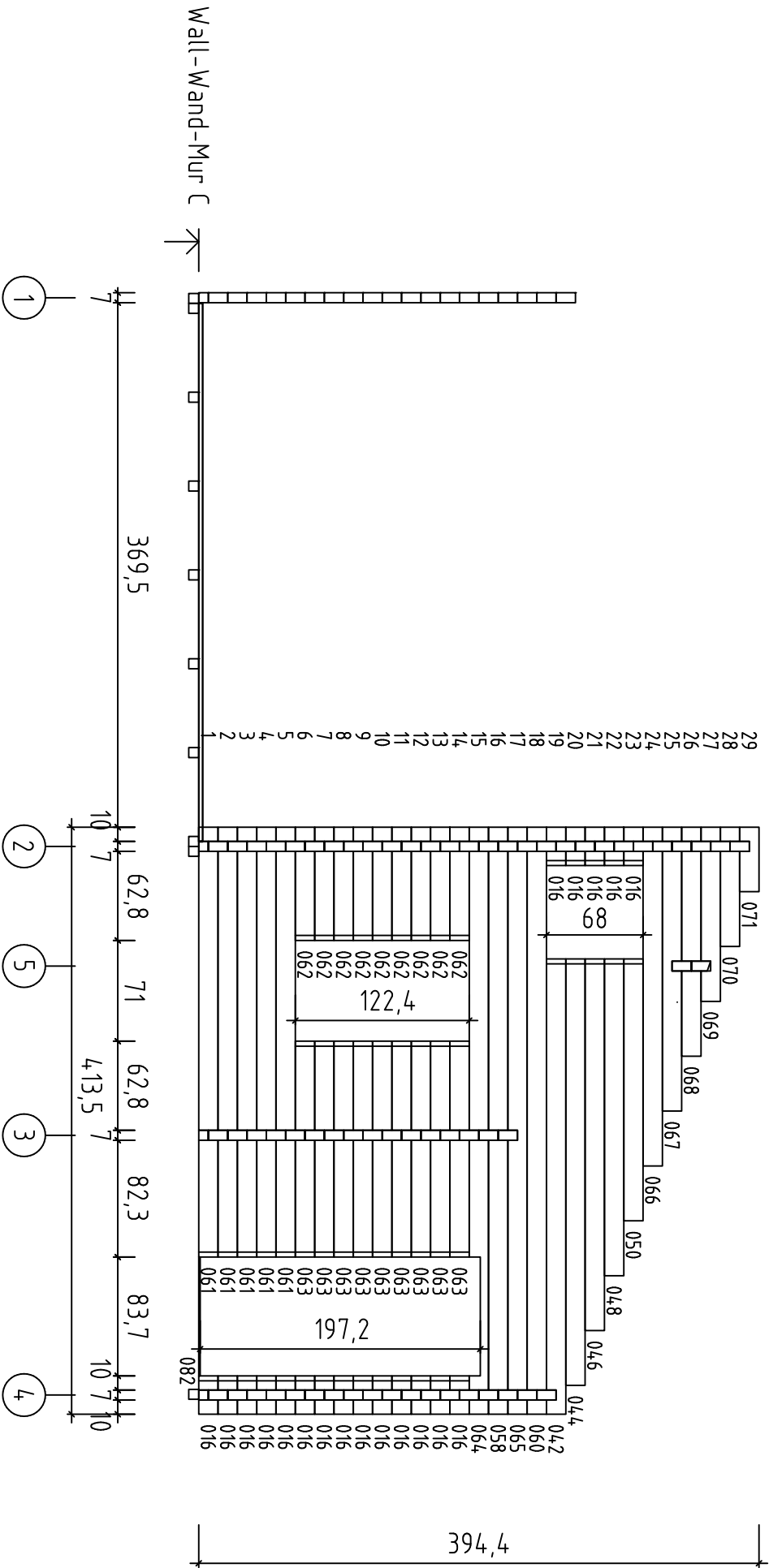

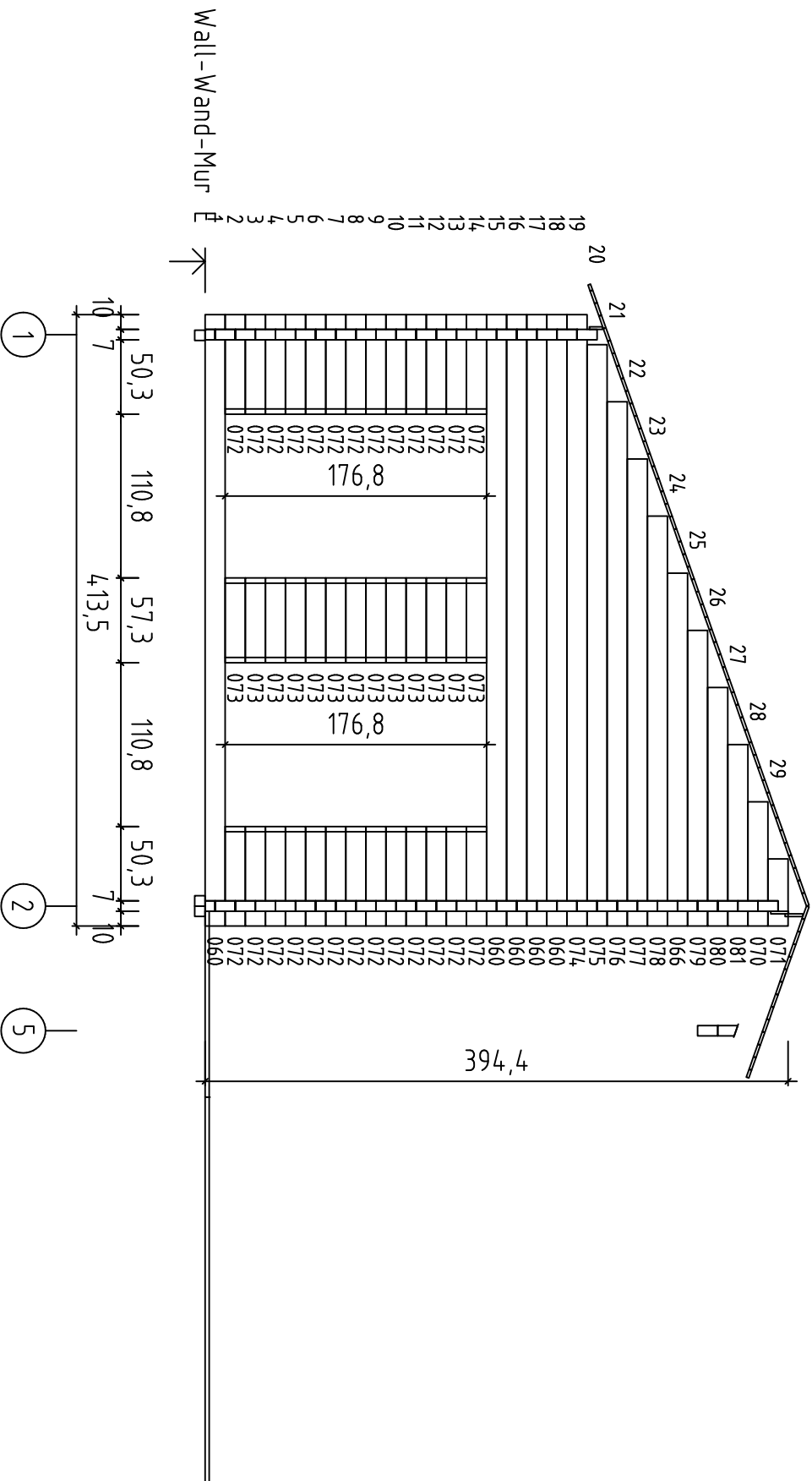

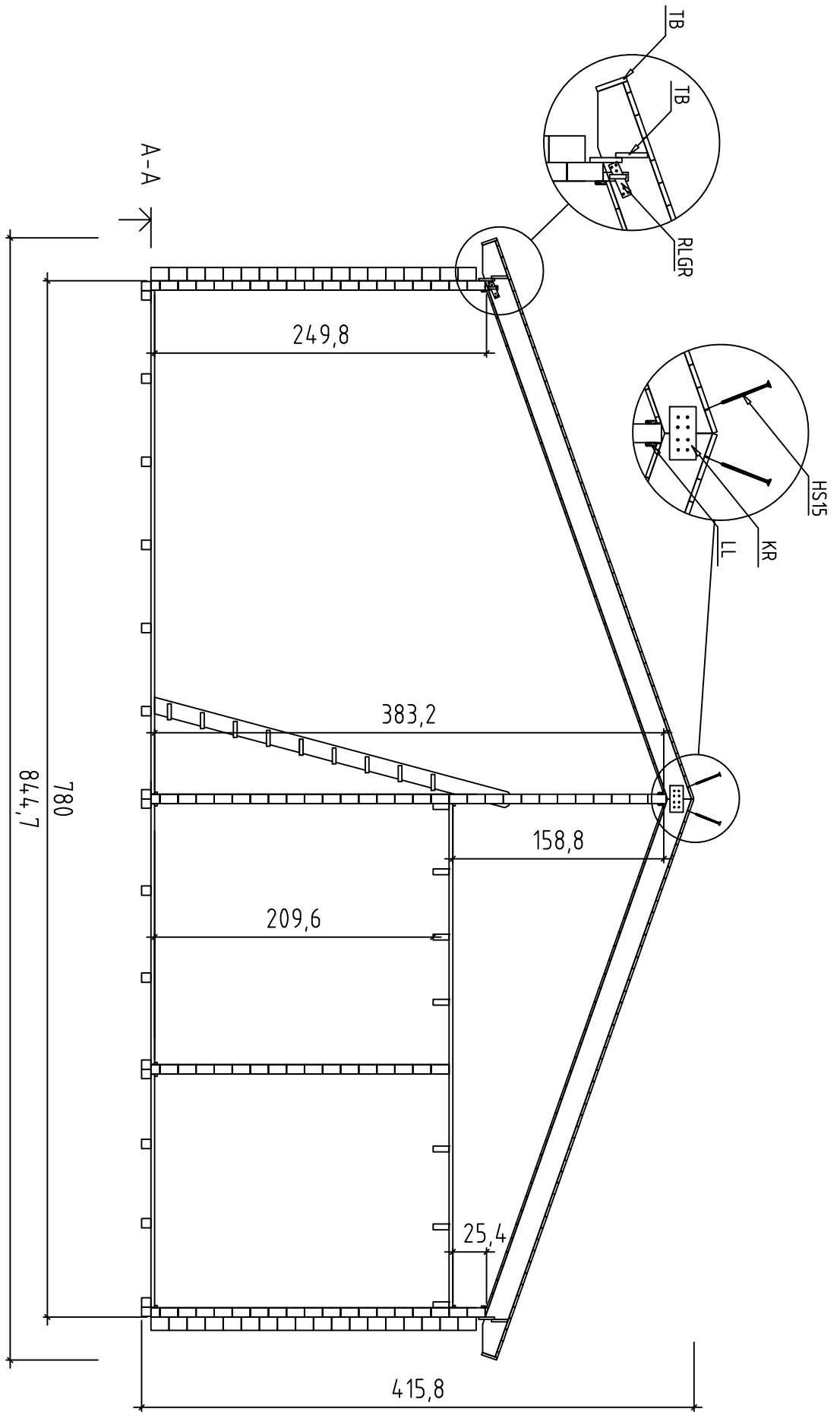

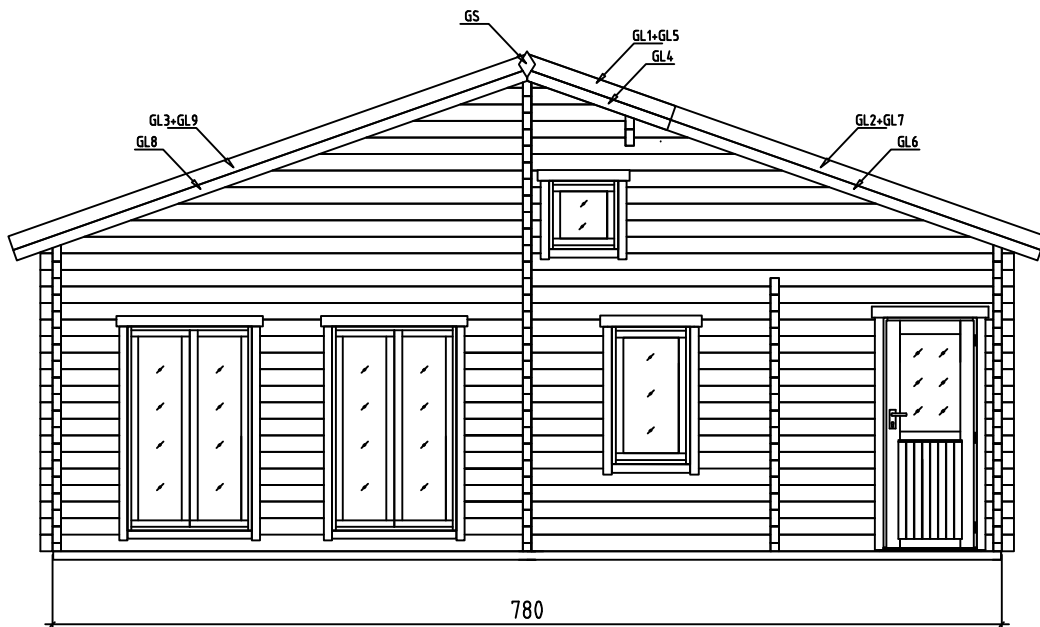
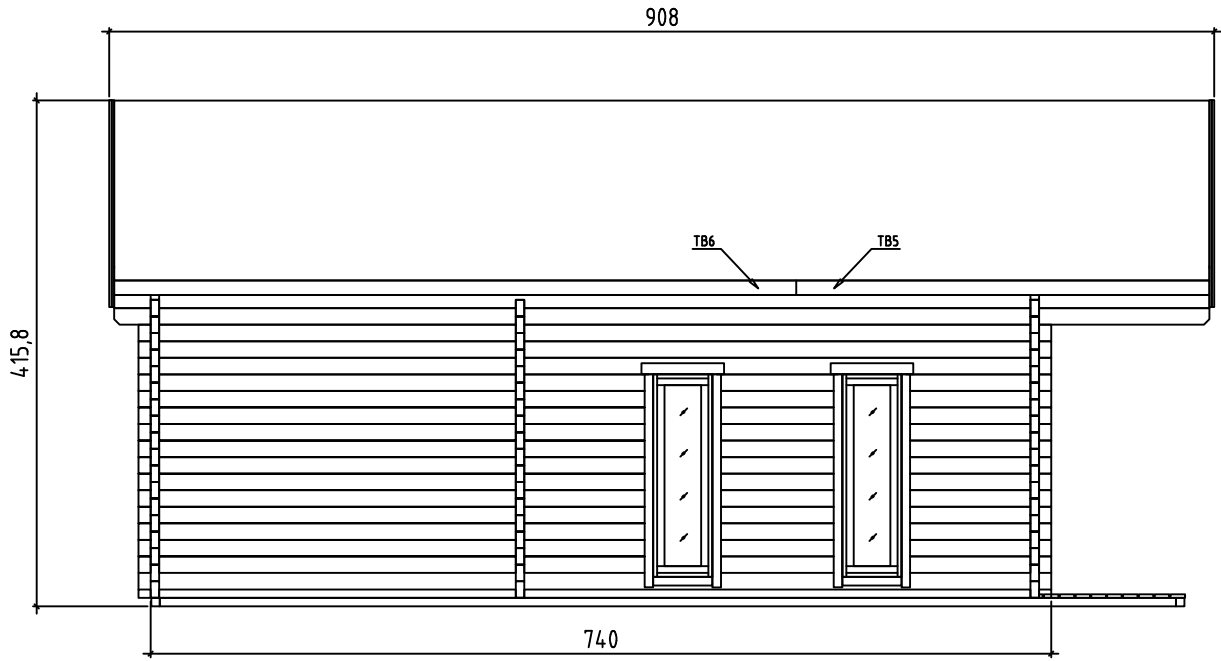

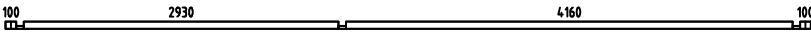
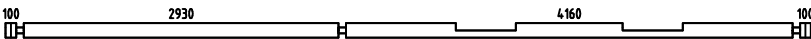
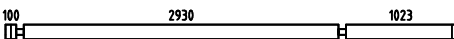
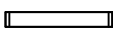
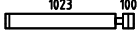
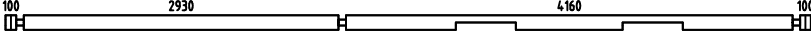
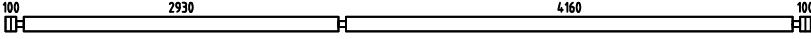
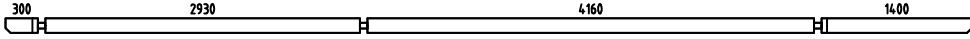
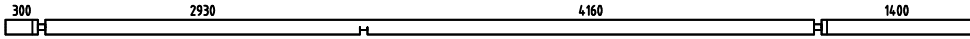

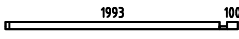

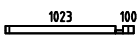

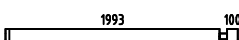

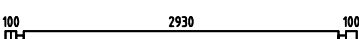
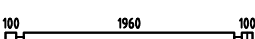
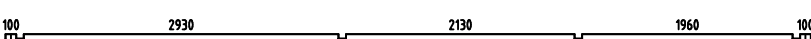

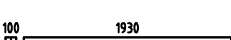





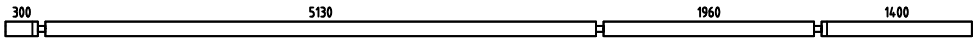
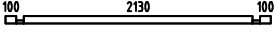
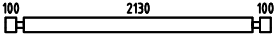
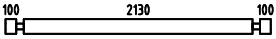
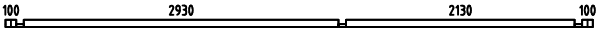
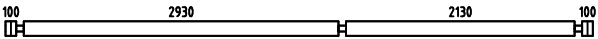
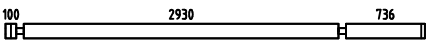
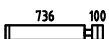
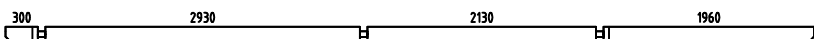
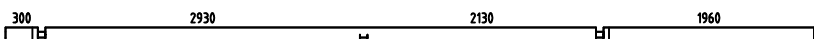
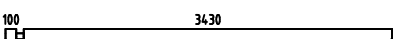
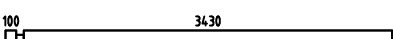
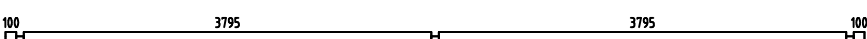
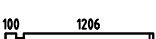

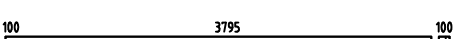



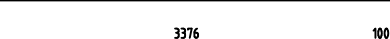

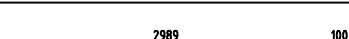
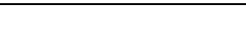
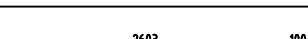
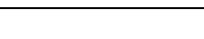

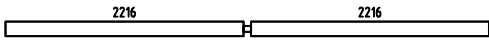
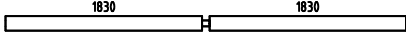
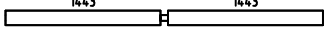
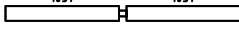
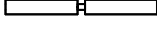

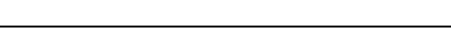
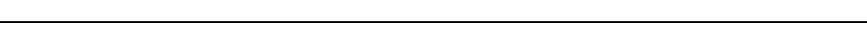
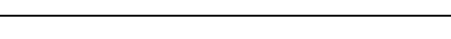
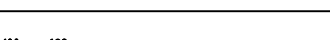



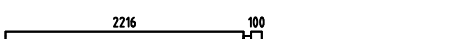
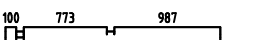
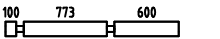
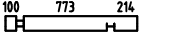
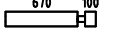
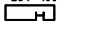



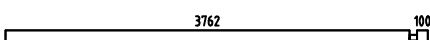

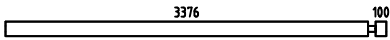
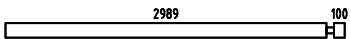
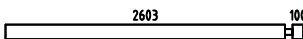
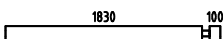
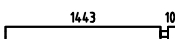
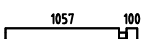

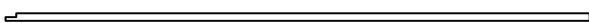
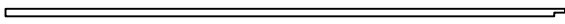
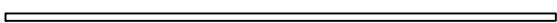













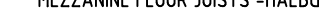



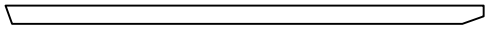
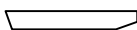



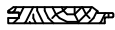



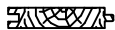
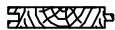







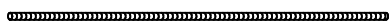











| Pos | GANGES, Job No. 702244 Piece list - Stückliste - Liste des pieces | Q. | P (mm) | L (mm) |
|-----|--|----|-----------|-----------|
| 001 |  | 1 | 70x68 | 7500 |
| 002 |  | 1 | 70x136 | 7500 |
| 003 |  | 12 | 70x136 | 4193 |
| 004 |  | 12 | 70x136 | 994 |
| 005 |  | 26 | 70x136 | 1193 |
| 006 |  | 1 | 70x136 | 7500 |
| 007 |  | 2 | 70x136 | 7500 |
| 008 |  | 1 | 70x136 | 9000 |
| 009 |  | 1 | 70x136 | 9000 |
| 010 |  | 1 | 70x68 | 270 |
| 011 |  | 1 | 70x68 | 2163 |
| 012 |  | 1 | 70x68 | 270 |
| 013 |  | 1 | 70x68 | 1193 |
| 014 |  | 14 | 70x136 | 270 |
| 015 |  | 14 | 70x136 | 2163 |
| 016 |  | 33 | 70x136 | 270 |
| 017 |  | 1 | 70x136 | 3270 |
| 018 |  | 1 | 70x136 | 2300 |
| 019 |  | 1 | 70x136 | 7500 |
| 020 |  | 1 | 70x136 | 7500 |
| 021 |  | 7 | 70x136 | 2100 |
| 022 |  | 1 | 70x136 | 4500 |
| 023 |  | 6 | 70x136 | 4500 |
| 024 |  | 1 | 70x136 | 7500 |
| 025 |  | 1 | 70x136 | 9000 |

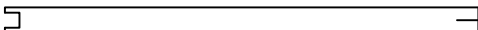
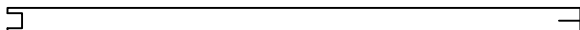
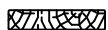
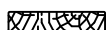
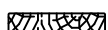
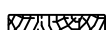
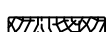
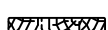







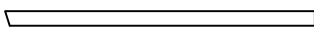

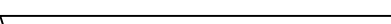
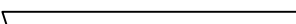

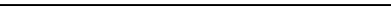



| Pos | GANGES, Job No. 702244 Piece list - Stückliste - Liste des pieces | Q. | P (mm) | L (mm) |
|-----|--|----|-----------|-----------|
| 026 |  | 2 | 70x136 | 9000 |
| 027 |  | 1 | 70x68 | 2470 |
| 028 |  | 15 | 70x136 | 2470 |
| 029 |  | 1 | 70x136 | 2470 |
| 030 |  | 1 | 70x68 | 5470 |
| 031 |  | 11 | 70x136 | 5470 |
| 032 |  | 5 | 70x136 | 3906 |
| 033 |  | 5 | 70x136 | 906 |
| 034 |  | 1 | 70x136 | 7530 |
| 035 |  | 1 | 70x136 | 7530 |
| 036 |  | 1 | 70x136 | 3600 |
| 037 |  | 1 | 70x136 | 3600 |
| 038 |  | 11 | 70x136 | 8000 |
| 039 |  | 14 | 70x136 | 1376 |
| 040 |  | 7 | 70x136 | 2481 |
| 041 |  | 1 | 70x136 | 4135 |
| 042 |  | 2 | 70x136 | 3207 |
| 043 |  | 1 | 70x136 | 3932 |
| 044 |  | 2 | 70x136 | 3004 |
| 045 |  | 1 | 70x136 | 3546 |
| 046 |  | 2 | 70x136 | 2618 |
| 047 |  | 1 | 70x136 | 3159 |
| 048 |  | 2 | 70x136 | 2231 |
| 049 |  | 1 | 70x136 | 2773 |
| 050 |  | 2 | 70x136 | 1845 |

















| Pos | GANGES, Art No. 702244 Piece list - Stückliste - Liste des pieces | Q. | P (mm) | L (mm) |
|-----|---|----|-----------|-----------|
| 051 |  | 1 | 70x136 | 4502 |
| 052 |  | 1 | 70x136 | 3729 |
| 053 |  | 1 | 70x136 | 2956 |
| 054 |  | 1 | 70x136 | 2183 |
| 055 |  | 1 | 70x136 | 1410 |
| 056 |  | 1 | 70x136 | 637 |
| 057 |  | 17 | 70x136 | 270 |
| 058 |  | 17 | 70x136 | 4135 |
| 059 |  | 1 | 70x136 | 8000 |
| 060 |  | 7 | 70x136 | 4135 |
| 061 |  | 5 | 70x136 | 3028 |
| 062 |  | 9 | 70x136 | 798 |
| 063 |  | 9 | 70x136 | 1521 |
| 064 |  | 1 | 70x136 | 4135 |
| 065 |  | 1 | 70x136 | 4135 |
| 066 |  | 2 | 70x136 | 2386 |
| 067 |  | 1 | 70x136 | 2000 |
| 068 |  | 1 | 70x136 | 1613 |
| 069 |  | 1 | 70x136 | 1227 |
| 070 |  | 2 | 70x136 | 840 |
| 071 |  | 2 | 70x136 | 454 |
| 072 |  | 26 | 70x136 | 673 |
| 073 |  | 13 | 70x136 | 573 |
| 074 |  | 1 | 70x136 | 4135 |
| 075 |  | 1 | 70x136 | 3932 |

| Pos | GANGES, Job No. 702244 Piece list - Stückliste - Liste des pieces | Q. | P (mm) | L (mm) |
|-------|--|----|-----------|-----------|
| 076 |  | 1 | 70x136 | 3546 |
| 077 |  | 1 | 70x136 | 3159 |
| 078 |  | 1 | 70x136 | 2773 |
| 079 |  | 1 | 70x136 | 2000 |
| 080 |  | 1 | 70x136 | 1613 |
| 081 |  | 1 | 70x136 | 1227 |
| 082 |  | 3 | 70x10 | 837 |
| IAR5 | FOUNDATION - FUNDAMENT - FONDATION  | 3 | 70x70 | 5440 |
| IAR9 | FOUNDATION - FUNDAMENT - FONDATION  | 4 | 70x70 | 5210 |
| IAR6 | FOUNDATION - FUNDAMENT - FONDATION  | 6 | 70x70 | 5125 |
| IAR11 | FOUNDATION - FUNDAMENT - FONDATION  | 3 | 70x70 | 4245 |
| IAR2 | FOUNDATION - FUNDAMENT - FONDATION  | 2 | 70x70 | 3945 |
| IAR1 | FOUNDATION - FUNDAMENT - FONDATION  | 2 | 70x70 | 3945 |
| IAR3 | FOUNDATION - FUNDAMENT - FONDATION  | 2 | 70x70 | 3755 |
| IAR10 | FOUNDATION - FUNDAMENT - FONDATION  | 1 | 70x70 | 3240 |
| IAR7 | FOUNDATION - FUNDAMENT - FONDATION  | 5 | 70x70 | 3155 |
| IAR4 | FOUNDATION - FUNDAMENT - FONDATION  | 6 | 70x70 | 3010 |
| IAR8 | FOUNDATION - FUNDAMENT - FONDATION  | 1 | 70x70 | 2400 |
| IAR13 | FOUNDATION - FUNDAMENT - FONDATION  | 3 | 70x70 | 2045 |
| IAR12 | FOUNDATION - FUNDAMENT - FONDATION  | 5 | 70x70 | 1125 |
| VT1 | MEZZANINE FLOOR JOISTS -HALBGESCHOSS BALKEN - SOLIVES DE PLANCHER MEZZANINE  | 1 | 45x70 | 3795 |
| VT2 | MEZZANINE FLOOR JOISTS -HALBGESCHOSS BALKEN - SOLIVES DE PLANCHER MEZZANINE  | 3 | 45x70 | 1965 |
| VT3 | MEZZANINE FLOOR JOISTS -HALBGESCHOSS BALKEN - SOLIVES DE PLANCHER MEZZANINE  | 3 | 45x70 | 1760 |
| VT4 | MEZZANINE FLOOR JOISTS -HALBGESCHOSS BALKEN - SOLIVES DE PLANCHER MEZZANINE  | 8 | 44x120 | 2930 |
| VT5 | MEZZANINE FLOOR JOISTS -HALBGESCHOSS BALKEN - SOLIVES DE PLANCHER MEZZANINE  | 7 | 44x120 | 2130 |

| Pos | GANGES, Job No. 702244 Piece list - Stückliste - Liste des pieces | | Q. | P (mm) | L (mm) |
|-----|---|---|-----|-----------|-----------|
| SR1 | RAFTER - DACHSPARREN - CHEVRON  | | 33 | 70x170 | 4453 |
| SR2 | RAFTER - DACHSPARREN - CHEVRON  | | 3 | 70x170 | 1227 |
| STP | CEILING BOARDS - DECKENBRETTER - VOLIGES SOUS PLAFOND |  | 37 | 111x15 | 5126 |
| STP | CEILING BOARDS - DECKENBRETTER - VOLIGES SOUS PLAFOND |  | 37 | 111x15 | 4461 |
| STP | CEILING BOARDS - DECKENBRETTER - VOLIGES SOUS PLAFOND |  | 15 | 111x15 | 2696 |
| STP | CEILING BOARDS - DECKENBRETTER - VOLIGES SOUS PLAFOND |  | 22 | 111x15 | 2695 |
| PTL | FLOOR BOARDS - FUSSBODENBRETTER - LAME DE PLANCHER |  | 137 | 112x28 | 3791 |
| PTL | FLOOR BOARDS - FUSSBODENBRETTER - LAME DE PLANCHER |  | 20 | 112x28 | 2035 |
| PTL | FLOOR BOARDS - FUSSBODENBRETTER - LAME DE PLANCHER |  | 19 | 112x28 | 1756 |
| RB1 | ROOF BOARDS - DACHBRETTER - VOLIGES |  | 100 | 90x18 | 5605 |
| RB2 | ROOF BOARDS - DACHBRETTER - VOLIGES |  | 64 | 90x18 | 3395 |
| RB3 | ROOF BOARDS - DACHBRETTER - VOLIGES |  | 36 | 90x18 | 1925 |
| SV2 | TERRACE BOARDS - TERRASSENBRETTER - PLANCHER DE TERRASSE |  | 5 | 120x28 | 5192 |
| SV2 | TERRACE BOARDS - TERRASSENBRETTER - PLANCHER DE TERRASSE |  | 5 | 120x28 | 4631 |
| SV2 | TERRACE BOARDS - TERRASSENBRETTER - PLANCHER DE TERRASSE |  | 15 | 120x28 | 3865 |
| SV2 | TERRACE BOARDS - TERRASSENBRETTER - PLANCHER DE TERRASSE |  | 5 | 120x28 | 3169 |
| SV2 | TERRACE BOARDS - TERRASSENBRETTER - PLANCHER DE TERRASSE |  | 5 | 120x28 | 2608 |
| LL | CEILING FILLET - DECKELEISTE - PROFIL DE FINITION POUR SOUS PLAFOND |  | | 15x40 | 40.64 |
| | FLOOR FILLET-FUSSBODENLEISTE - CORNIERE DE FINITION DU PLANCHER |  | | 18x18 | 65 |
| M12 | TREADED ROD M12 - GEWINDESTANGE M12 - TIGE FILETÉE M12 |  | 4 | | 545 |
| M12 | TREADED ROD M12 - GEWINDESTANGE M12 - TIGE FILETÉE M12 |  | 2 | | 1910 |
| M12 | TREADED ROD M12 - GEWINDESTANGE M12 - TIGE FILETÉE M12 |  | 6 | | 2000 |
| LPL | FIXING FILLET - FIXIRUNGSLEISTE - PROFIL DE FIXATION |  | 4 | 20x70 | 512 |
| LPL | FIXING FILLET - FIXIRUNGSLEISTE - PROFIL DE FIXATION |  | 6 | 20x70 | 610 |
| LPL | FIXING FILLET - FIXIRUNGSLEISTE - PROFIL DE FIXATION |  | 6 | 20x70 | 650 |

| Pos | GANGES, Job No. 702244 Piece list - Stückliste - Liste des pieces | | Q. | P (mm) | L (mm) |
|------|--|---|----|-----------|-----------|
| LPL | FIXING FILLET - FIXIRUNGSLEISTE - PROFIL DE FIXATION |  | 2 | 20x70 | 662 |
| LPL | FIXING FILLET - FIXIRUNGSLEISTE - PROFIL DE FIXATION |  | 3 | 20x70 | 787 |
| LPL | FIXING FILLET - FIXIRUNGSLEISTE - PROFIL DE FIXATION |  | 4 | 20x70 | 916 |
| LPL | FIXING FILLET - FIXIRUNGSLEISTE - PROFIL DE FIXATION |  | 4 | 20x70 | 1060 |
| LPL | FIXING FILLET - FIXIRUNGSLEISTE - PROFIL DE FIXATION |  | 2 | 20x70 | 1190 |
| LPL | FIXING FILLET - FIXIRUNGSLEISTE - PROFIL DE FIXATION |  | 4 | 20x70 | 1334 |
| LPL | FIXING FILLET - FIXIRUNGSLEISTE - PROFIL DE FIXATION |  | 8 | 20x70 | 1729 |
| LPL | FIXING FILLET - FIXIRUNGSLEISTE - PROFIL DE FIXATION |  | 6 | 20x70 | 1933 |
| P1 | POST - PFOSTEN - POTEAU |  | 1 | 120x120 | 2205 |
| P2 | POST - PFOSTEN - POTEAU |  | 1 | 120x120 | 3290 |
| TB1 | EAVES BOARD - TRAUFBRETT - BANDEAU DE TOIT |  | 12 | 18x120 | 560 |
| TB2 | EAVES BOARD - TRAUFBRETT - BANDEAU DE TOIT |  | 32 | 18x120 | 562 |
| TB3 | EAVES BOARD - TRAUFBRETT - BANDEAU DE TOIT |  | 1 | 18x120 | 1434 |
| TB4 | EAVES BOARD - TRAUFBRETT - BANDEAU DE TOIT |  | 1 | 18x120 | 1925 |
| TB5 | EAVES BOARD - TRAUFBRETT - BANDEAU DE TOIT |  | 1 | 18x120 | 3395 |
| TB6 | EAVES BOARD - TRAUFBRETT - BANDEAU DE TOIT |  | 2 | 18x120 | 5605 |
| TBE6 | FIXING FILLET FOR WINDOW - FIXIRUNGSLEISTE FÜR FENSTER - PROFIL DE FIXATION DES FENETRES |  | 4 | 28x34 | 616 |
| TBE6 | FIXING FILLET FOR WINDOW - FIXIRUNGSLEISTE FÜR FENSTER - PROFIL DE FIXATION DES FENETRES |  | 6 | 28x34 | 650 |
| TBE6 | FIXING FILLET FOR WINDOW - FIXIRUNGSLEISTE FÜR FENSTER - PROFIL DE FIXATION DES FENETRES |  | 2 | 28x34 | 1190 |
| TBE6 | FIXING FILLET FOR WINDOW - FIXIRUNGSLEISTE FÜR FENSTER - PROFIL DE FIXATION DES FENETRES |  | 4 | 28x34 | 1564 |
| TBE6 | FIXING FILLET FOR WINDOW - FIXIRUNGSLEISTE FÜR FENSTER - PROFIL DE FIXATION DES FENETRES |  | 4 | 28x34 | 1729 |
| TBE6 | FIXING FILLET FOR DOOR - FIXIRUNGSLEISTE FÜR TÜR - PROFIL DE FIXATION DES PORTES |  | 2 | 28x34 | 1826 |
| TBE6 | FIXING FILLET FOR DOOR - FIXIRUNGSLEISTE FÜR TÜR - PROFIL DE FIXATION DES PORTES |  | 4 | 28x34 | 1920 |
| TG1 | GUARD-RAIL FOR TERRACE - TERRASSEN GELÄNDER - MAIN COURANTE DE TERRASSE |  | 1 | 18x90 | 1600 |
| GL1 | GABLE MOULDING - GIEBELLEISTE - PLANCHE DE RIVE |  | 1 | 18x90 | 1293 |

| Pos | GANGES, Job No. 702244 Piece list - Stückliste - Liste des pieces | | Q. | P (mm) | L (mm) |
|------|--|---|-----|-----------|-----------|
| GL2 | GABLE MOULDING - GIBELLEISTE - PLANCHE DE RIVE |  | 1 | 18x90 | 3589 |
| GL3 | GABLE MOULDING - GIBELLEISTE - PLANCHE DE RIVE |  | 3 | 18x90 | 4519 |
| GL4 | GABLE MOULDING - GIBELLEISTE - PLANCHE DE RIVE |  | 1 | 18x120 | 1261 |
| GL5 | GABLE MOULDING - GIBELLEISTE - PLANCHE DE RIVE |  | 1 | 18x120 | 1293 |
| GL6 | GABLE MOULDING - GIBELLEISTE - PLANCHE DE RIVE |  | 1 | 18x120 | 3557 |
| GL7 | GABLE MOULDING - GIBELLEISTE - PLANCHE DE RIVE |  | 1 | 18x120 | 3589 |
| GL8 | GABLE MOULDING - GIBELLEISTE - PLANCHE DE RIVE |  | 3 | 18x120 | 4488 |
| GL9 | GABLE MOULDING - GIBELLEISTE - PLANCHE DE RIVE |  | 3 | 18x120 | 4519 |
| KL4 | LENGTHENING BOLT FOR TREADED ROD - VERLÄNGERUNGSMUTTER FÜR GEWINDESTANGE - MANCHON DE RACCORDEMENT DE TIGE FILETÉE |  | 6 | | |
| KL1 | DRIVE NUT TREADED ROD - EINSHLAGMUTTER FÜR GEWINDESTANGE - ÉCROU A FRAPPER POUR TIGE FILITÉE |  | 6 | | |
| KL2 | NUT FOR TREADED ROD - MUTTER FÜR GEWINDESTANGE - ÉCROU POUR TIGE FILETÉE |  | 6 | | |
| KL3 | PLAIN WASHER TREADED ROD - UNTERLEGSCHIEBE FÜR GEWINDESTANGE - RONDELLE PLATE POUR TIGE FILETÉE |  | 6 | | |
| HS12 | SCREW FOR GABLE SEGMENT - SCHRAUBEN FÜR DECKBLATT - VIS POUR FIXATION LOSANGE DE FINITION |  | 4 | 3.5x50 | |
| HS83 | SCREW FOR FIXING FILLET - SCHRAUBEN FÜR FIXIRUNGSLEISTE - VIS POUR PROFIL DE FIXATION |  | 192 | 3.5x50 | |
| HS32 | SCREW FOR EAVES BOARDS - SCHRAUBEN FÜR TRAUFBRETT - VIS DE FIXATION POUR BANDEAU DE TOIT |  | 66 | 3.5x50 | |
| HS84 | SCREW FOR FIXING FILLET - SCHRAUBEN FÜR FIXIRUNGSLEISTE - VIS POUR PROFIL DE FIXATION |  | 112 | 3.5x50 | |
| HS16 | SCREW FOR GABLE MOULDING - SCHRAUBEN FÜR GIBELLEISTE - VIS DE FIXATION POUR PLANCHE DE RIVE |  | 126 | 3.5x50 | |
| HS73 | SCREW FOR CONNECTING PLATE - SCHRAUBE FÜR ANSCHLUSSPLATTE - VIS DE FIXATION DES PLAQUES DE CONNEXION |  | 144 | 4x40 | |
| HS32 | SCREW FOR EAVES BOARDS - SCHRAUBEN FÜR TRAUFBRETT - VIS DE FIXATION POUR BANDEAU DE TOIT |  | 132 | 4x40 | |
| HS86 | SCREW FOR RAFTER SLIDER - SCHRAUBEN FÜR DACHSPARREN SCHIEBEREGLER - VIS DE FIXATION CURSEUR POUR CHEVRON |  | 288 | 4x40 | |
| HS30 | SCREW FOR TERRACE REAR BOARDS - SCHRAUBEN FÜR TERRASSEN RAND - VIS DE FIXATION POUR MAIN COURANTE DE TERRASSE |  | 4 | 4x40 | |
| HS34 | SCREW FOR POST - SCHRAUBEN FÜR PFOSTEN - VIS DE FIXATION DES POTEAUX |  | 4 | 4x60 | |
| HS30 | SCREW FOR TERRACE RAILING - SCHRAUBEN FÜR TERRASSEN RAND VIS DE GARDE-CORPS DE TERRASSE |  | 4 | 4x60 | |
| HS36 | SCREW FOR STEPLADDER - SCHRAUBE FÜR LEITER - VIS D'ASSEMBLAGE DES MARCHES DE L'ECHELLE |  | 36 | 4x60 | |
| HS86 | SCREW FOR MEZZANINE FLOOR JOISTS - SCHRAUBEN FÜR HALBGESCHOSS BALKEN - VIS DE FIXATION SOLIVES DE PLANCHER MEZZANINE |  | 68 | 5x100 | |

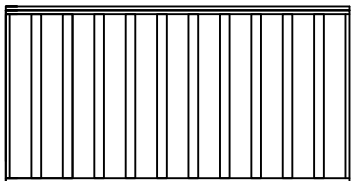
| Pos | GANGES, Job No. 702244 Piece list - Stückliste - Liste des pieces | | | Q. | P (mm) | L (mm) |
|------|--|---|-----|--------|-----------|-----------|
| HS40 | SCREW FOR 1. WALL BEAM - SCHRAUBE FÜR 1. BOHLENREIHE - VIS DE FIXATION DES FONDATIONS |  | 19 | 5x120 | | |
| HS39 | SCREW FOR FUNDAMENT - SCHRAUBEN ZUR BEFESTIGUNG FUNDAMENT - VIS POUR FONDATION |  | 100 | 5x120 | | |
| HS49 | SCREW FOR POST HEIGHT ADJUSTMENT - SCHRAUBEN FÜR REGULIERUNGS-SCHRAUBE FÜR PFOSTEN - VIS DE FIXATION DE SUPPORT RÉGLABLE DE POTEAU |  | 16 | 6x50 | | |
| HS15 | SCREW FOR RAFTER - SCHRAUBEN ZUR BEFESTIGUNG DACHSPARREN VIS POUR CHEVRON |  | 36 | 8x220 | | |
| MS | SCREW FOR DOORSTEP - SCHRAUBEN FÜR TÜRSCHWELLE - VIS DE FIXATION DU SEUIL DE PORTE |  | 6 | 4.5x65 | | |
| SH70 | HAMMER BLOCK - SCHLAGHOLZ - CALLE DE FRAPPE |  | 2 | | | |
| NF3 | ZN NAIL FOR TERRACE - ZN NÄGEL FÜR TERRASSENBRETT - POINTE POUR PLANCHER DE TERRASSE |  | 1 | 2x50 | | |
| NFF | ZN NAIL FOR FILLETS - ZN NÄGEL FÜR LEISTEN - POINTE POUR CORNIERE |  | 1 | 1.4x40 | | |
| NF2 | ZN NAIL FOR ROOF - ZN NÄGEL FÜR DACHBRETT - POINTE POUR TOIT |  | 1 | 2x50 | | |
| NF2 | ZN NAIL FOR CEILING BOARDS - ZN NÄGEL FÜR DECKENBRETT - CLOUS POUR VOLIGES SOUS PLAFONDS |  | 1 | 2x50 | | |
| NH1 | ZN NAIL FOR FLOOR - ZN NÄGEL FÜR FUSSBODENBRETT - CLOUS POUR PLANCHER |  | 1 | 2x50 | | |
| KR | CONNECTING PLATE - ANSCHLUSSPLATTE - PLAQUE MÉTALLIQUE DE CONNEXION |  | 18 | | | |
| ORZ | MONTAGE SET FOR DOORS AND WINDOWS - MONTAGE-SET FÜR TÜREN UND FENSTER - JEU DE MONTAGE PORTES ET FENETRES | | 1 | | | |
| PP | BOLT M8 - BOLZEN M8 - BOULON M8 |  | 1 | | | |
| GS | GABLE SEGMENT-DECKBLATT - LOSANGE DE FINITION |  | 2 | | | |
| RLGR | SLIDER FOR RAFTER - SCHIEBEREGLER FÜR DACHSPARREN - SABOT MÉTALLIQUE POUR FIXATION CHEVRON |  | 36 | | | |
| KL5 | PLAIN WASHER - UNTERLEGSCHIEBE - RONDELLE |  | 1 | | | |
| RFP | POST HEIGHT ADJUSTMENT - REGULIERUNGSSCHRAUBE FÜR PFOSTEN - SUPPORT RÉGLABLE DE POTEAU |  | 2 | | | |
| TRR1 | TERRACE RAILING - TERRASSE - GARDE-CORPS DE TERRASSE |  | 1 | 303x44 | 1600 | |
| | | | | | | |
| | | | | | | |
| | | | | | | |

Pos

Q.

P
(mm)

L
(mm)

LR LADDER - LEITER - ECHELLE

1

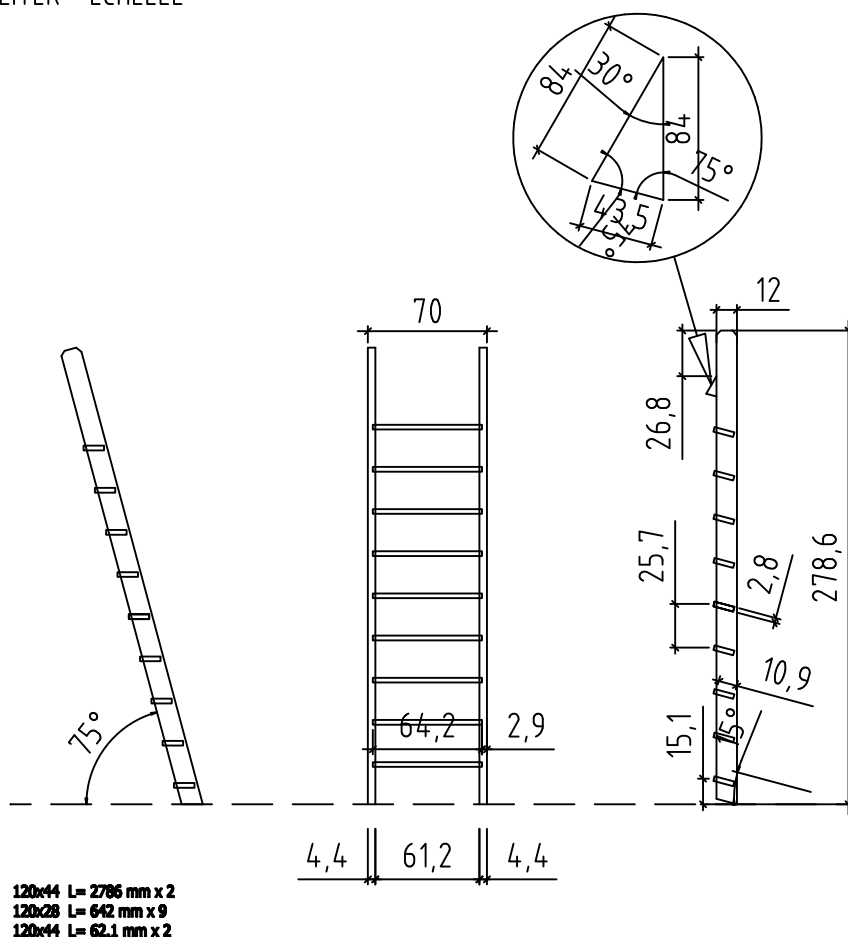

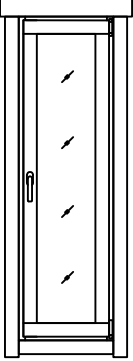
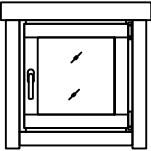
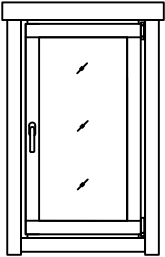
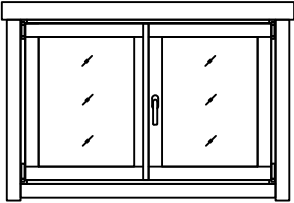
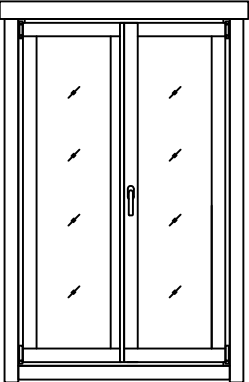
| Pos | GANGES, Art No. 702244 Piece list - Stückliste - Liste des pieces | Q. | P (mm) | L (mm) |
|------------------------|---|----|-----------|-----------|
| Week end A.OP.b | WINDOW-FENSTER-FENETRE 552x1729  | 2 | | |
| Weekend A.OP.c | WINDOW-FENSTER-FENETRE 650x650  | 3 | | |
| Week end A.OP.d | WINDOW-FENSTER-FENETRE 702x1190  | 1 | | |
| Weekend TA.OP | WINDOW-FENSTER-FENETRE 1374x916  | 2 | | |
| Weekend TA .OP.b | WINDOW-FENSTER-FENETRE 1100x1729  | 1 | | |
| | | | | |

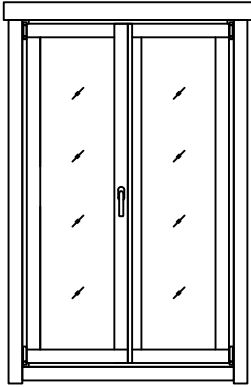
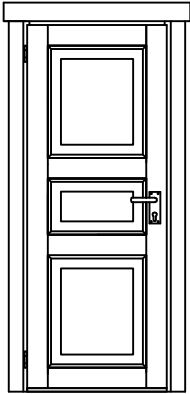
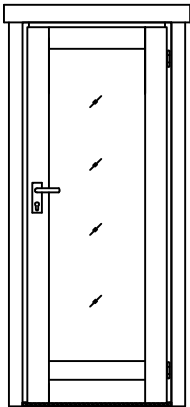
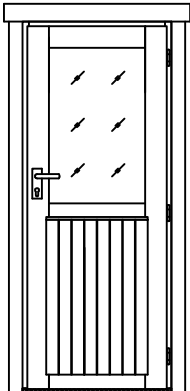
| Pos | GANGES, Art No. 702244 Piece list - Stückliste - Liste des pieces | Q. | P (mm) | L (mm) |
|-------------------------|---|----|-----------|-----------|
| Weeke nd TA .0V.b | WINDOW-FENSTER-FENETRE 1100x1729  | 1 | | |
| U.3TV | DOOR-TÜR-PORTE 827x1933  | 1 | | |
| Weeken d U.10P | DOOR-TÜR-PORTE 827x1933  | 1 | | |
| Weeken d U.20P | DOOR-TÜR-PORTE 827x1933  | 1 | | |

