

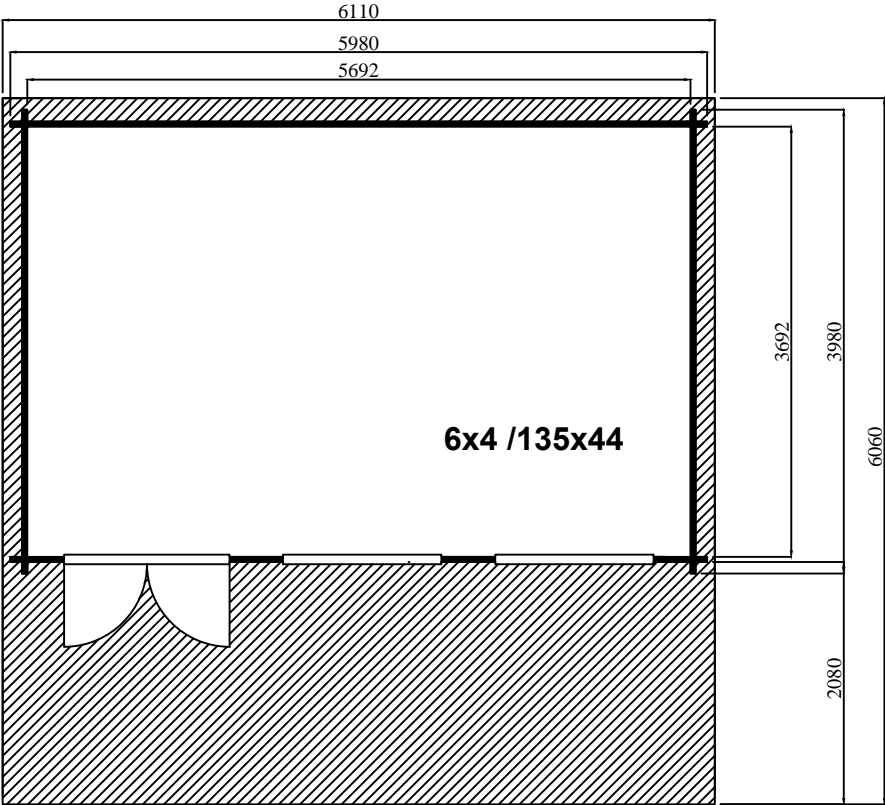

# AUFBAUANLEITUNG SAAR 2

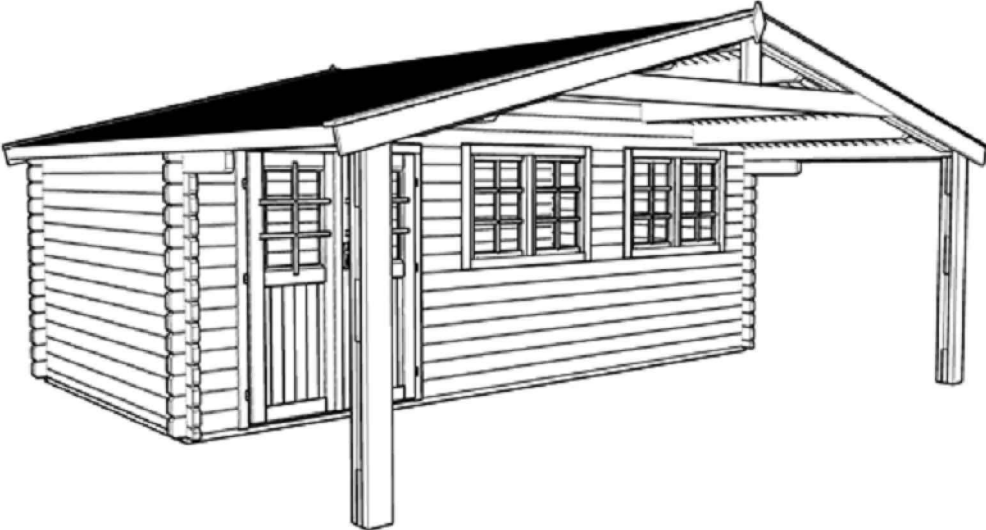





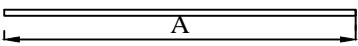
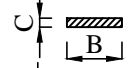
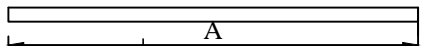

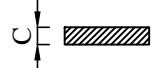
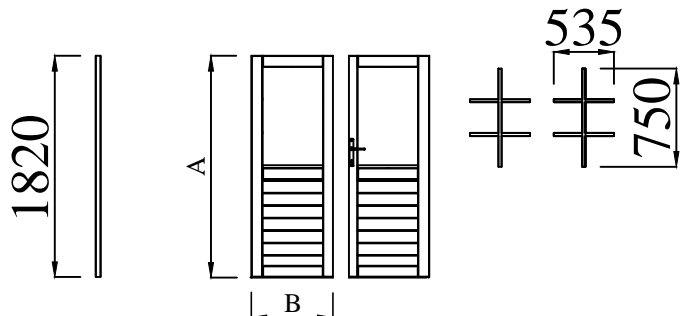
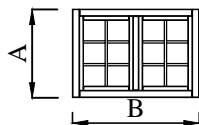
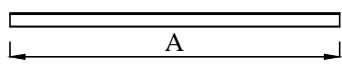
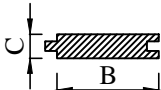
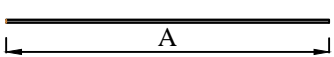
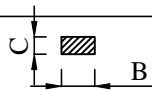

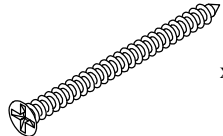
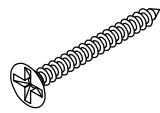
SAAR 2

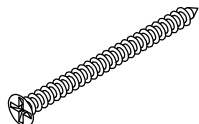
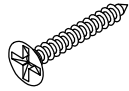
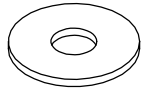
Nr.	Menge	Abmessungen, mm			Details	
		A	B	C		
1.1	x 3	3780	60	40		
1	x 16	2800	60	40		
B1	x 14+1	5980	135	44		
C1	x 2	3980	68	44		
C2	x 24	3980	135	44		
A2	x 7	4100	135	44		
A3	x 21	460	135	44		
A4	x 14	460	135	44		
C4	x 2	4480	135	44		
C3	x 1+1	5980	135	44		
Sp1	x 6	5980	140	44		
Sp2	x 1	5980	140	44		
Wp1	x 2	5980	671	44		
Wp2	x 1	5980	751	80		
Pf	x 2	1870	120	120		
TR1	x 1	1494	82	90		
TR2	x 2	1860	75	82		
TR3	x 1	1320	44	40		
Db	x 138+2	3120	88	18		
Wb1	x 4	3170	90	19		
Wb2	x 4	3170	60	19		

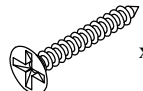
SAAR 2

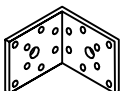
L1	x 6	2020	40	16		
L2	x 4	3030	60	19		
D	x 2	200	100	19		
T1 T2	1+1	1820	665	40		
F1	x 2	1035	1410			
Bb	x 65+2	2105	88	18		
Bb	x 65+2	1575	88	18		
BL	x 10	1897	28	19		

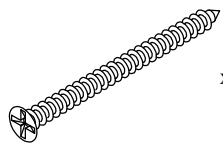
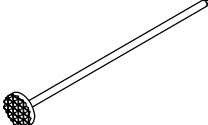
5 x 90	4 x 40	09 13 GZN	501/33Fe/HME
 x 16	 x 184	 x 6	 x 4
5 x 70 mm	3 x 30	M8	AH9213
 x 4	 x 98	 x 8	 x 1
3 x 20 mm	7,5 x 92		US-40-01
 x 12	 x 8	 x 32	 x 2
5 x 120 mm	2 x 40 mm		
 x 18	 x 1340		

SAAR 2

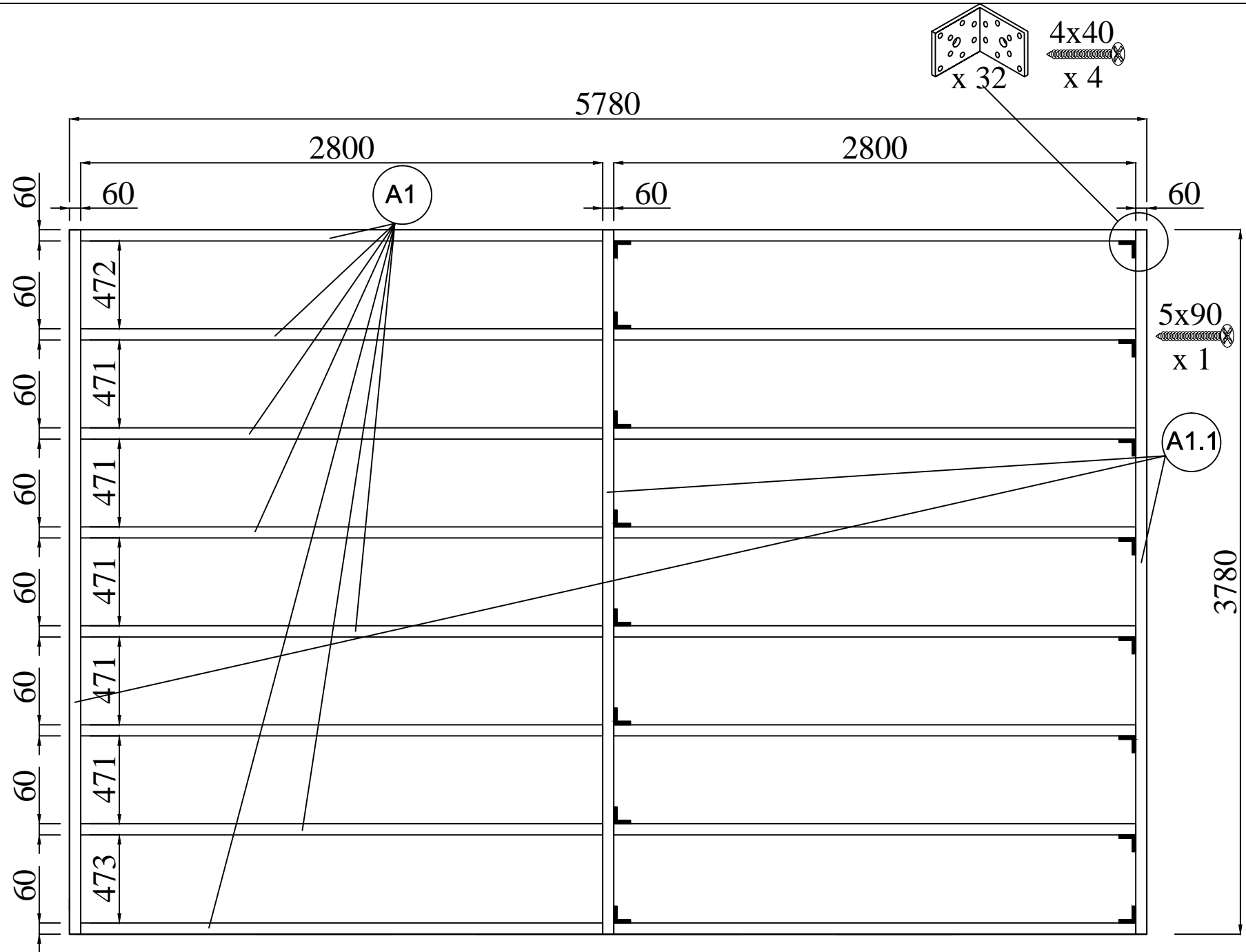

SAAR 2

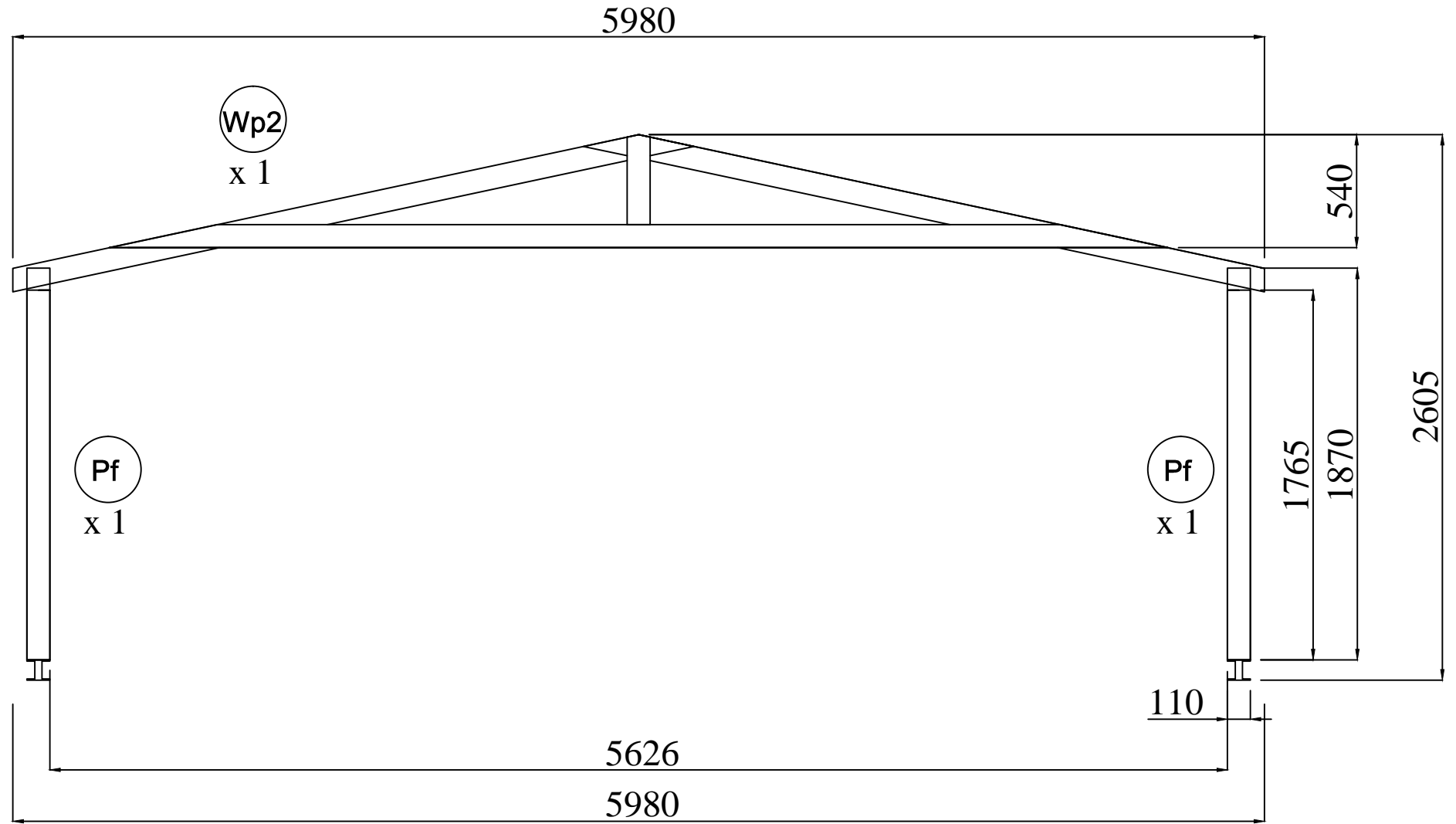

# SAAR 2

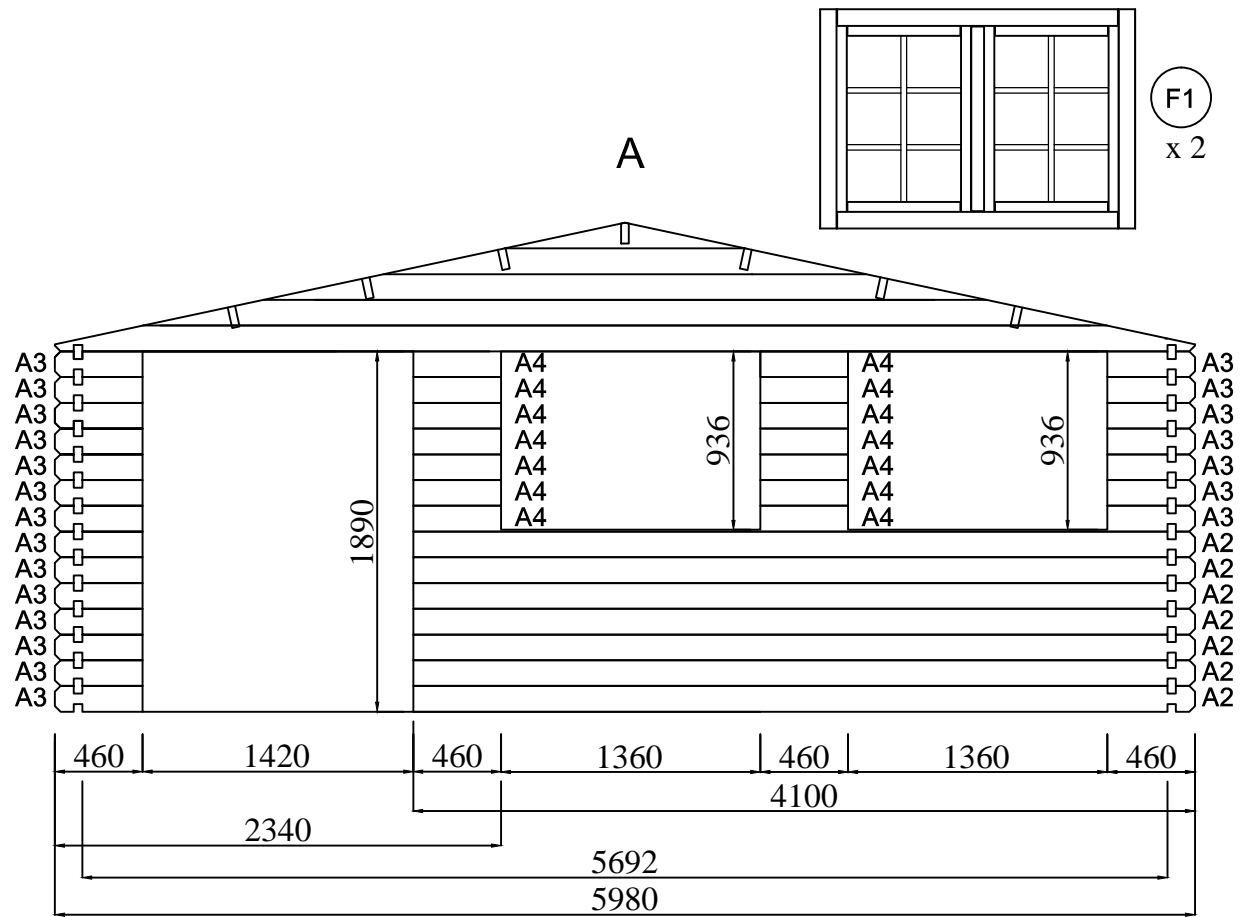
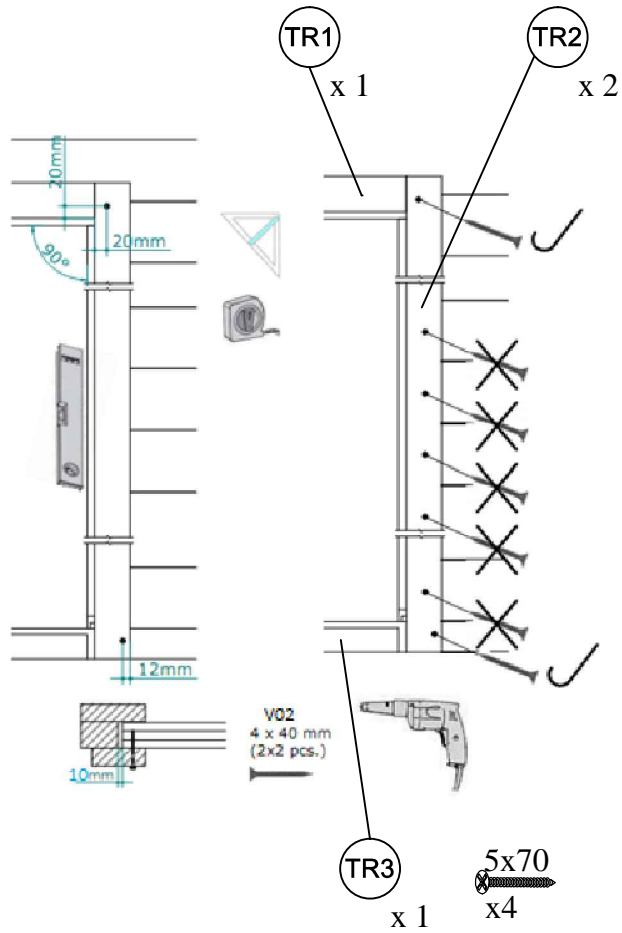

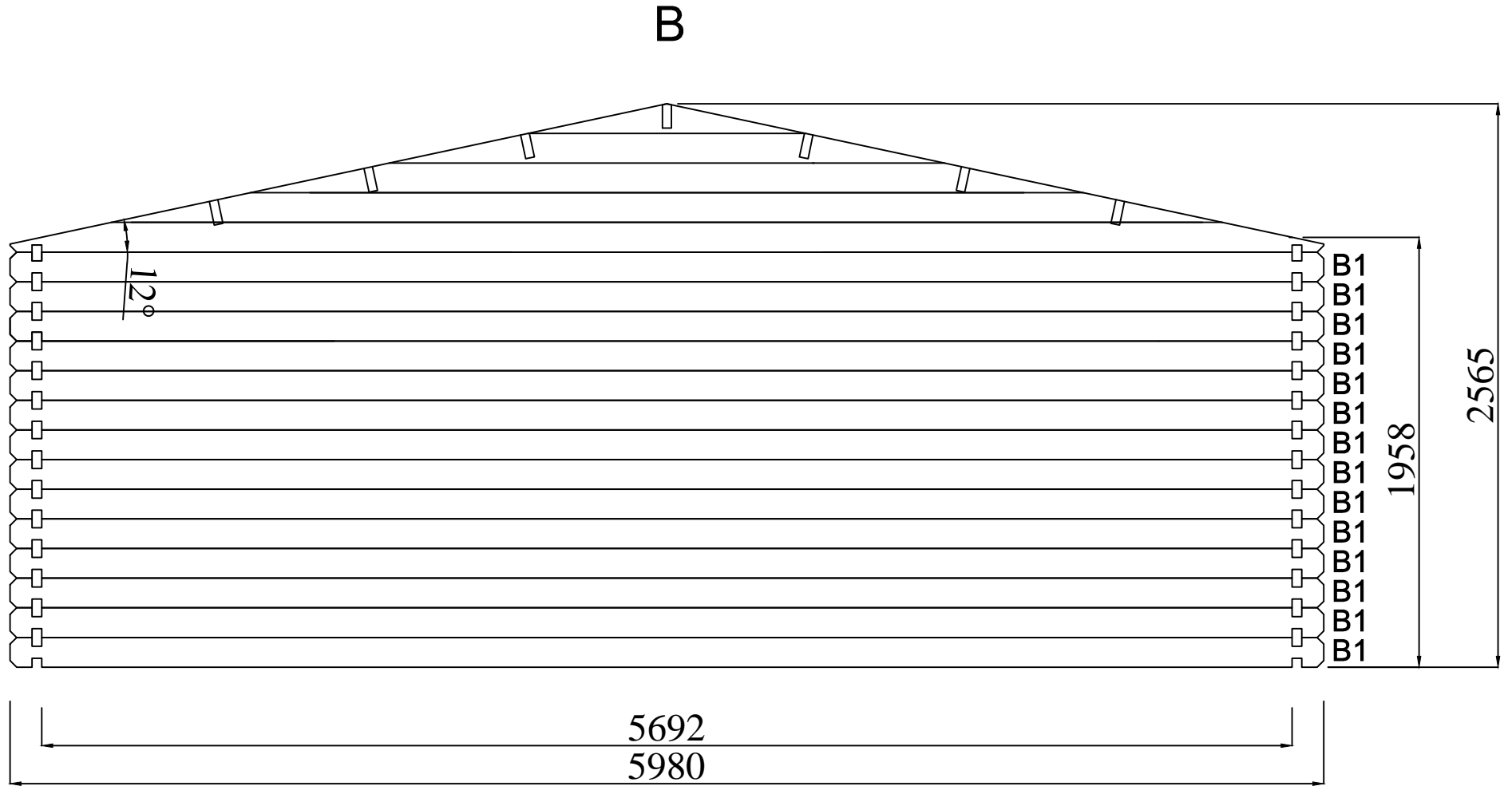

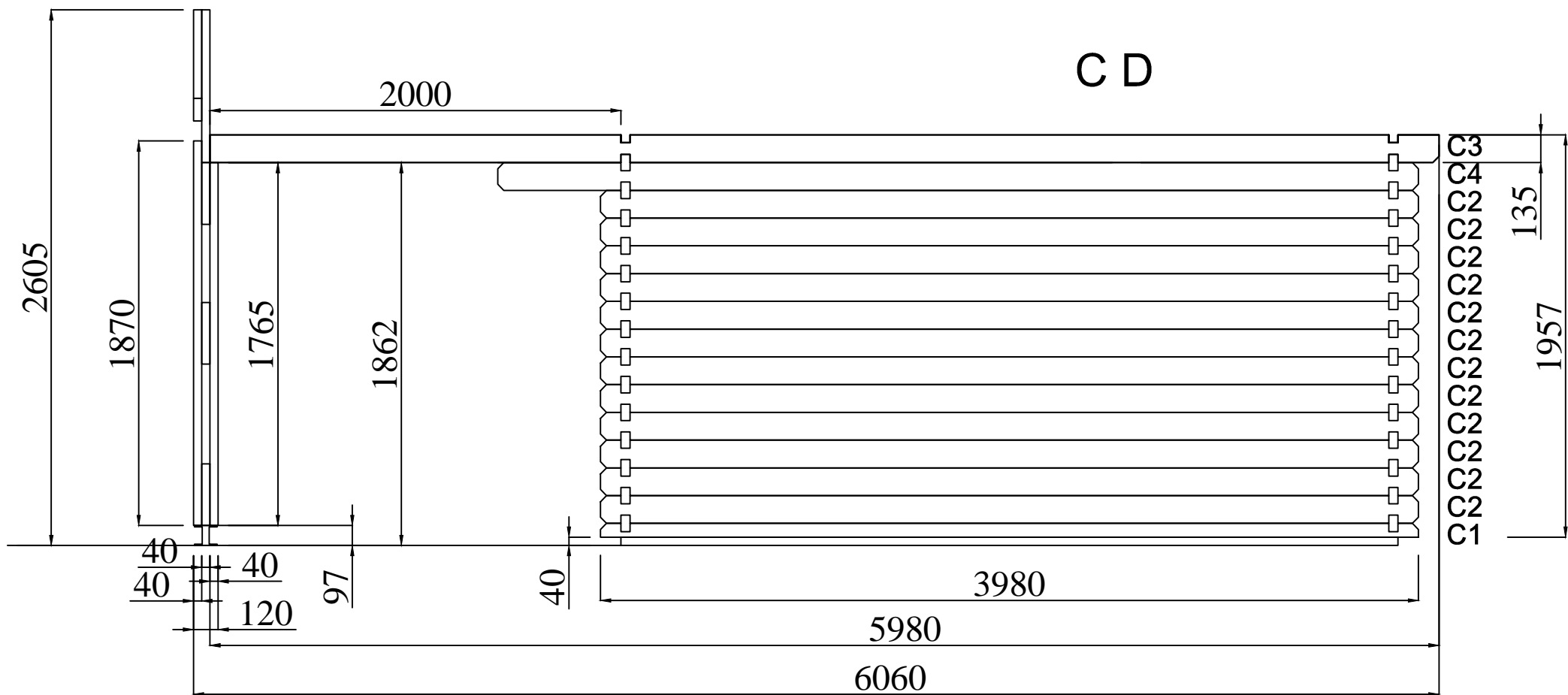



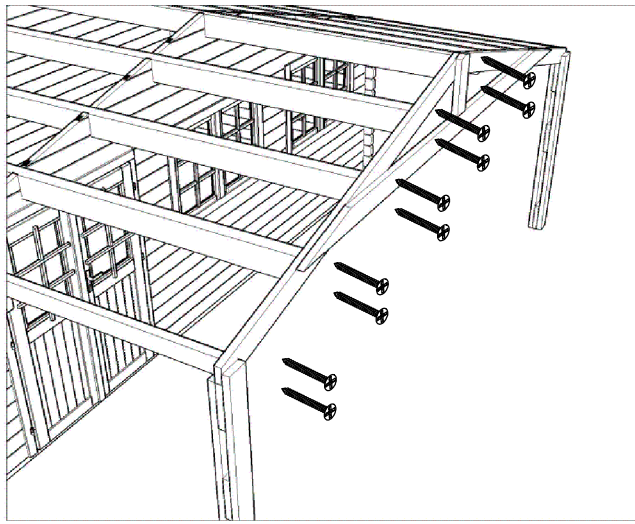

5x120  
x18

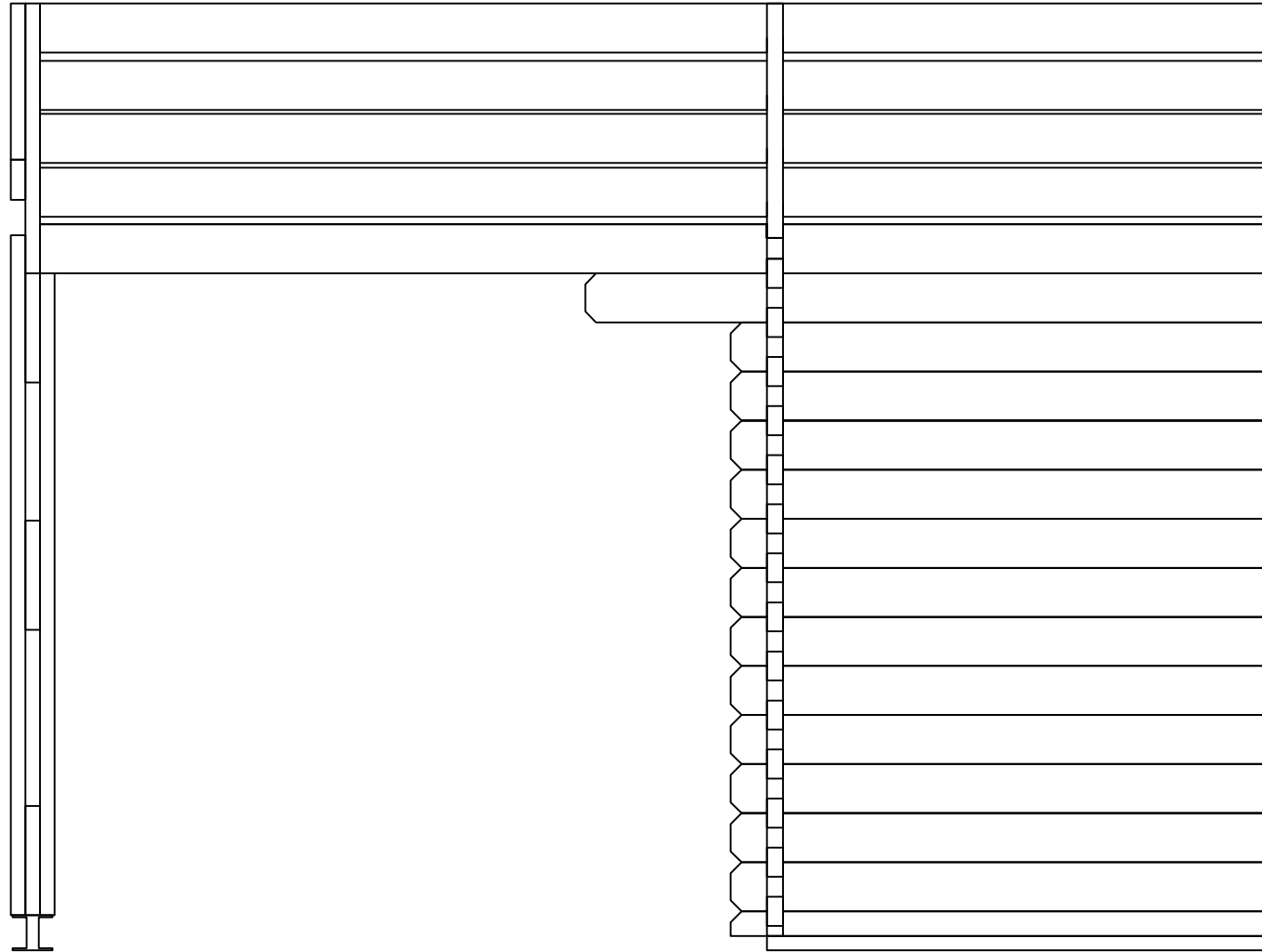
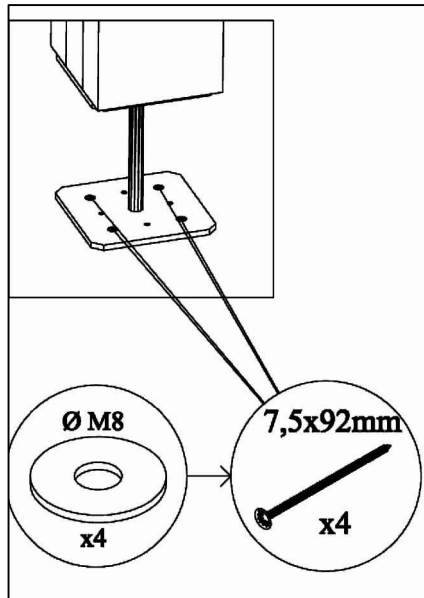
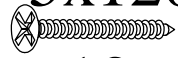

SAAR 2

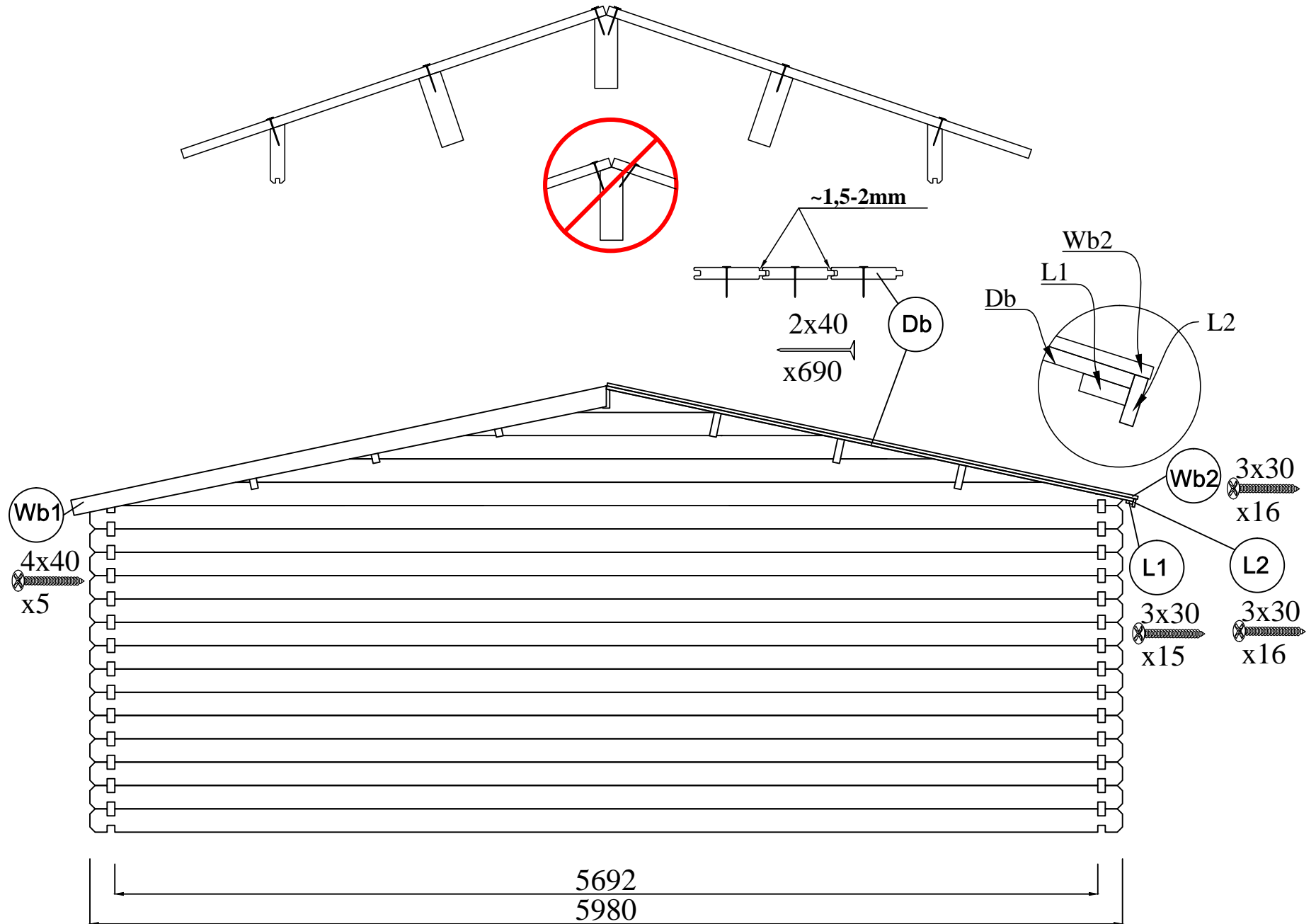

SAAR 2

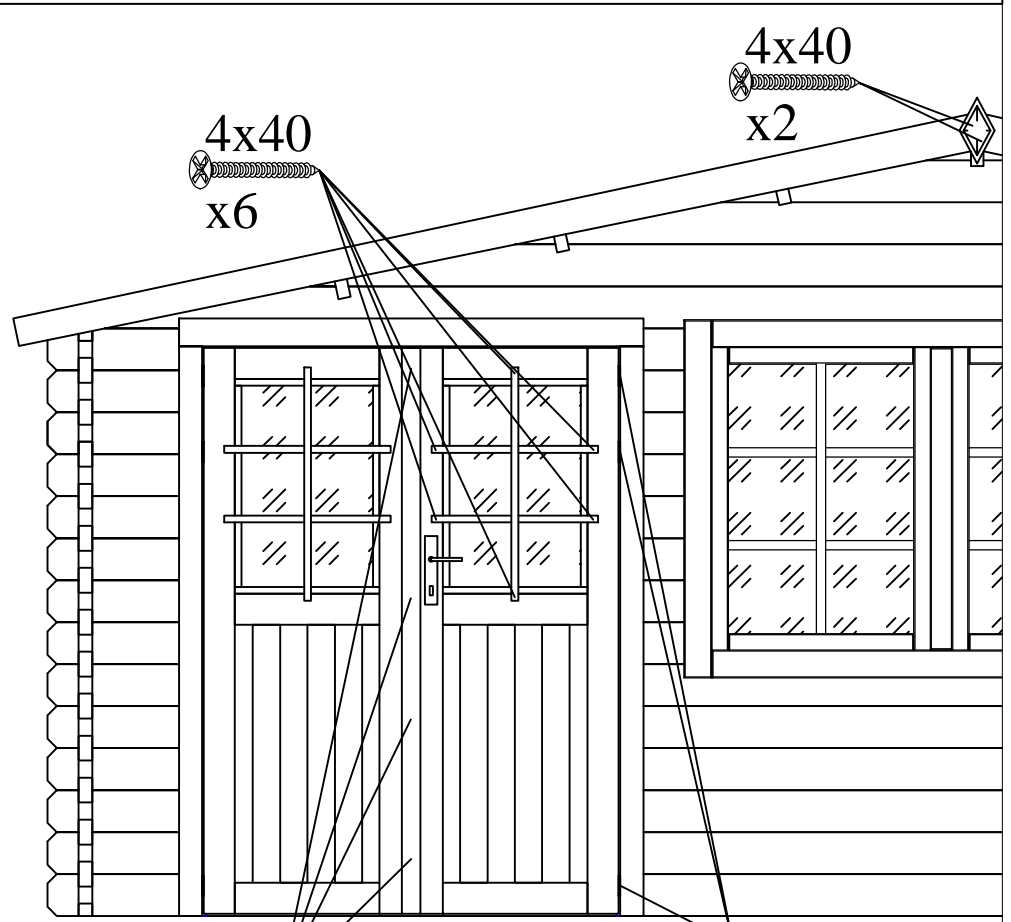
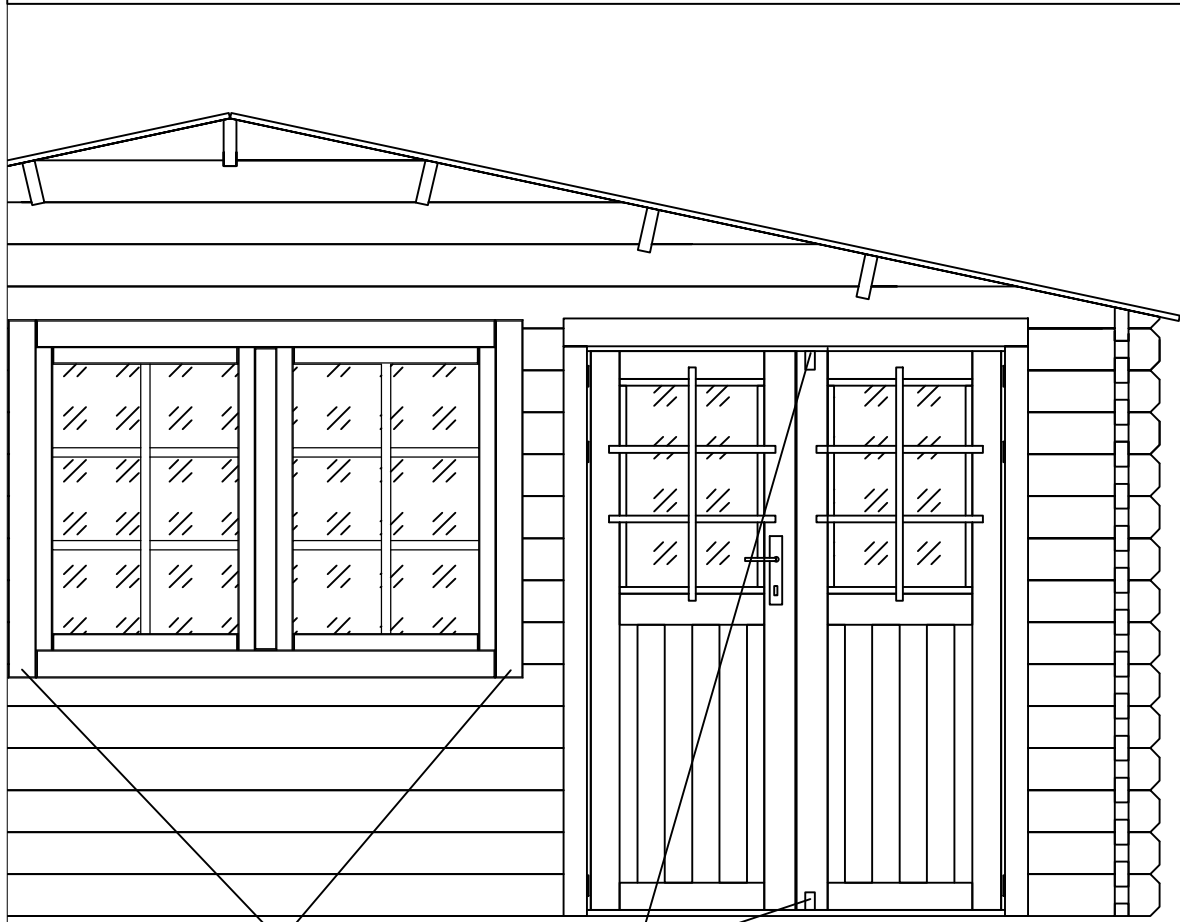

4x40  
x2

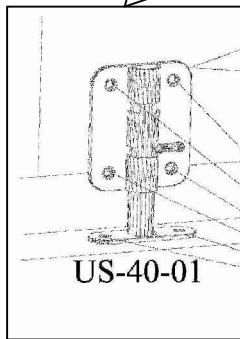

3x20  
x6

4x40  
x6

4x40  
x2

3x30  
x4

4x40  
x2

# SAAR 2

