

Date rev. Description

V 1.0

House	3402280 Sina 34	Sheet	1
Drawing	3D	Scale	
Material	34X135	Date	03.03.2022
Drawer	K.K.	File	3402280 Sina 34_3D.dwg

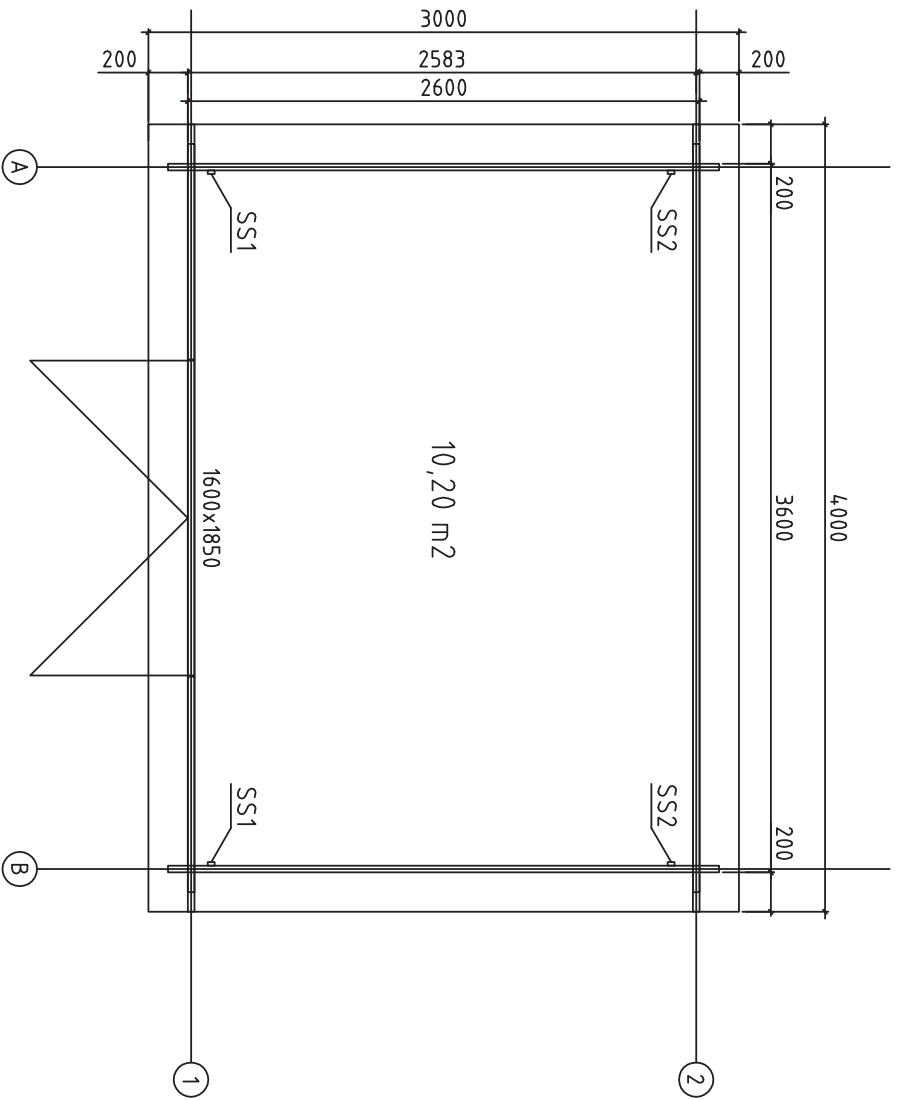

House	34,02280 Sina 34	Sheet	2
Drawing	Plan	Scale	1:35
Material	34x135	Date	03.03.2022
Drawer	K.K.	File	34,02280 Sina 34.dwg

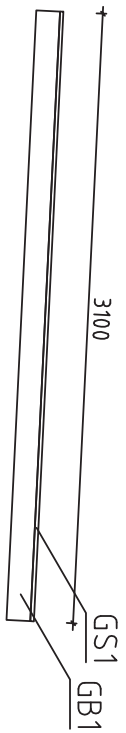

Wall-Wand-Muur A

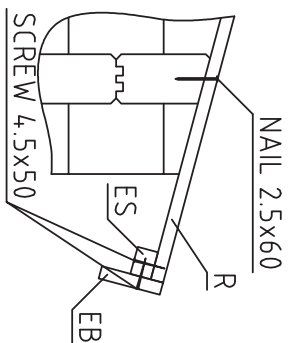
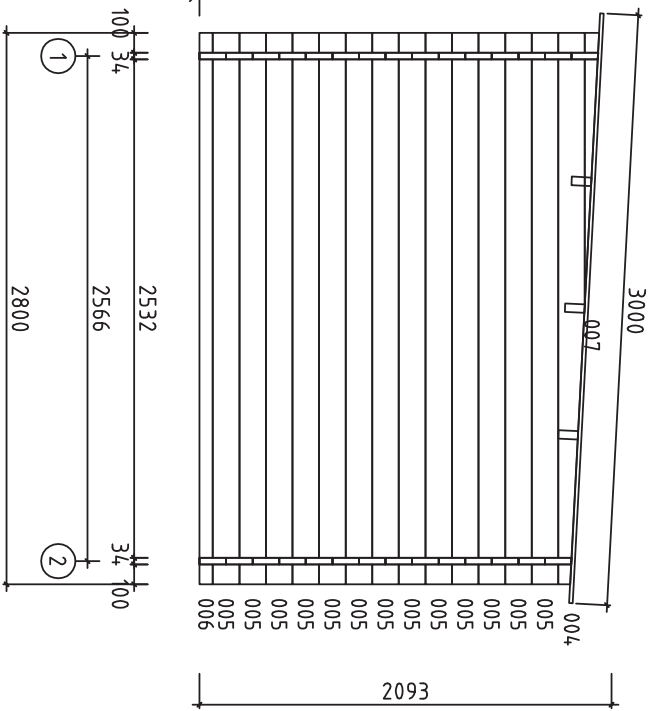

House	34.02280 Sina 34	Sheet	3
Drawing	WALL-WAND-MUUR A	Scale	1:35
Material	3.4x13.5	Date	03.03.2022
Drawer	K.K.	File	34.02280 Sina 34.dwg

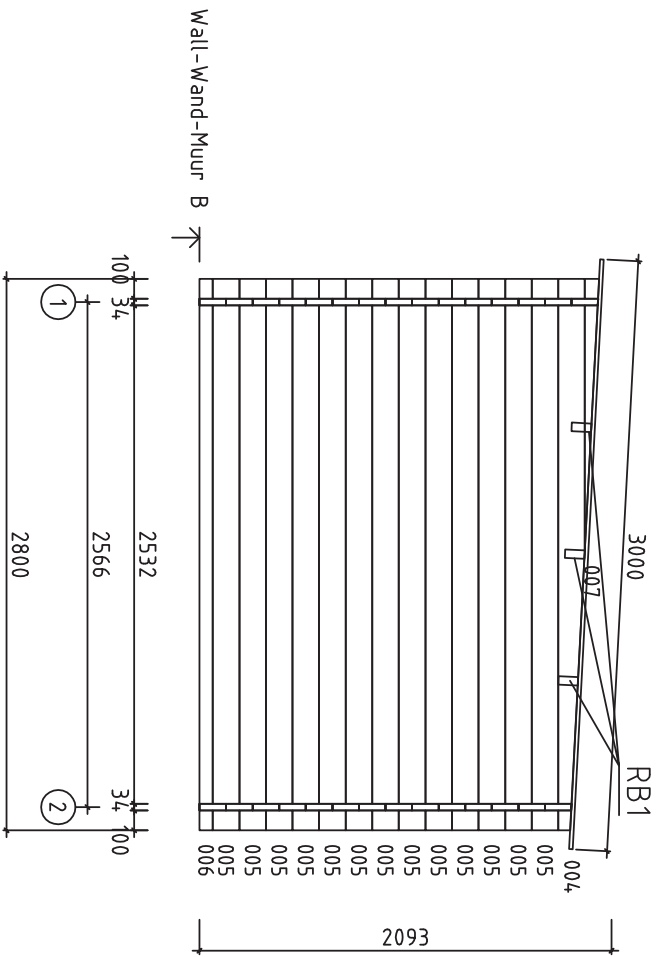



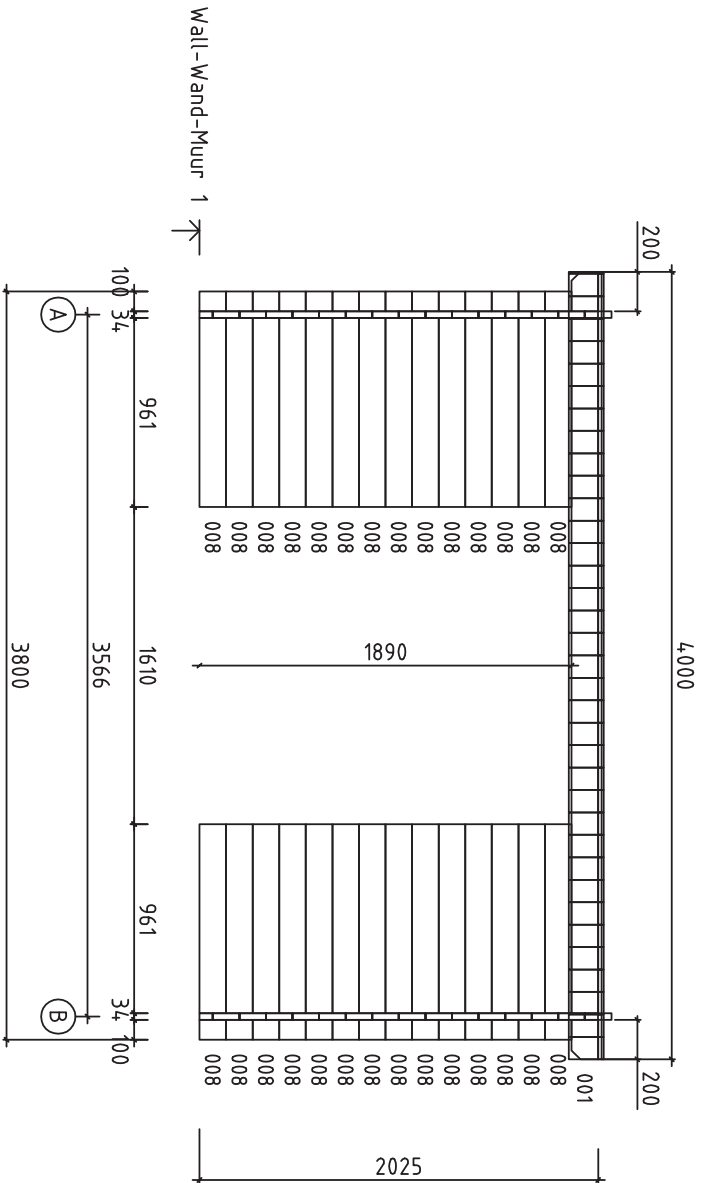



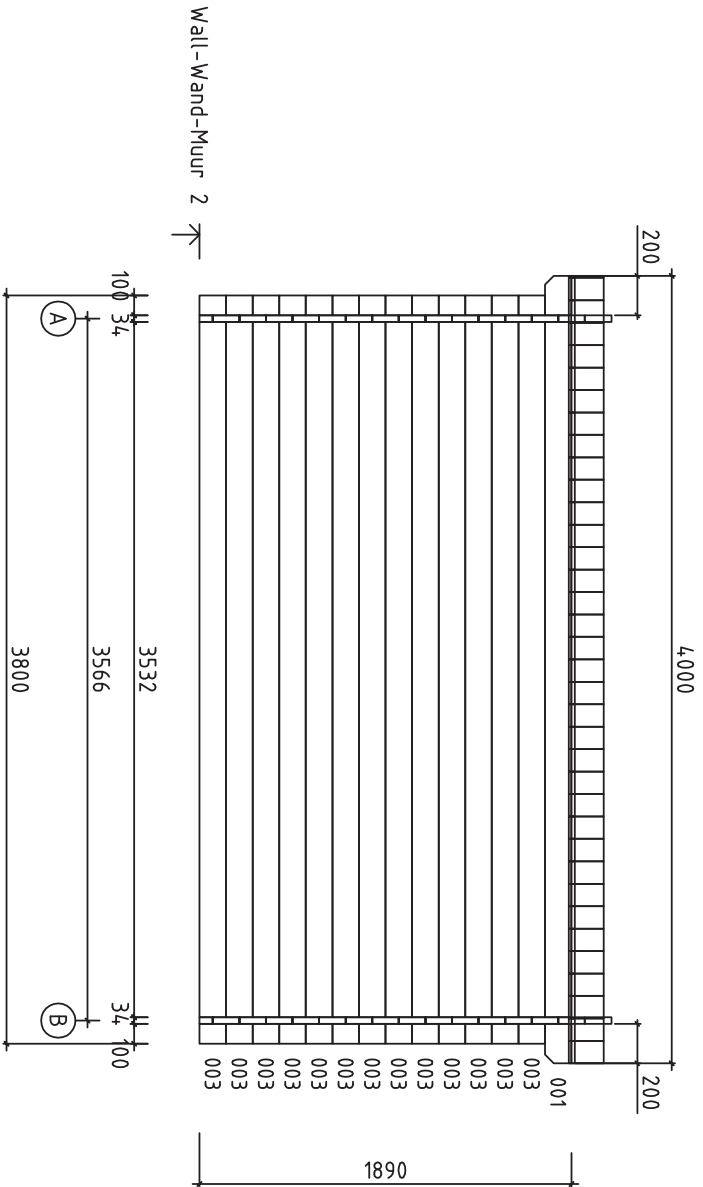



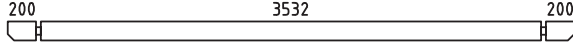
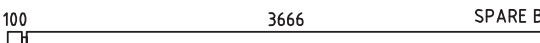
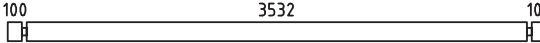
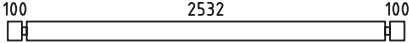
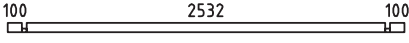
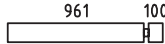
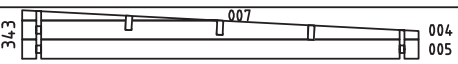
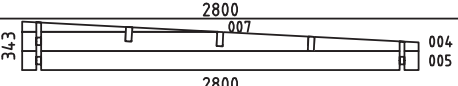



House	34.02280 Sina 34	Sheet	4
Drawing	WALL-WAND-MUUR B	Scale	1:35
Material	3.4x13.5	Date	03.03.2022
Drawer	K.K.	File	34.02280 Sina 34.dwg



House	34,02280 Sina 34	Sheet	5
Drawing	WALL-WAND-MUUR 1	Scale	1:35
Material	3.4x13.5	Date	03.03.2022
Drawer	K.K.	File	34,02280 Sina 34.dwg



House	34.02280 Sina 34	Sheet	6
Drawing	WALL-WAND-MUUR 2	Scale	1:35
Material	3.4x13.5	Date	03.03.2022
Drawer	K.K.	File	34.02280 Sina 34.dwg

Pos	Specification-Bestimmung-Omschrijving 3402280 Sina 34	Pcs	Profile (mm)	L (mm)
001		2	34x135	4000
002	 SPARE BEAM-ERZATZBOHLE-VOORRAADPLANK	1	34x135	3800
003		13	34x135	3800
005		24	34x135	2800
006		2	34x68	2800
008		28	34x135	1095
WA-1		1	34x343	2800
WB-1		1	34x343	2800
HB	HIT BLOCK-SCHLAGHÖLZER-BLAZENPLANK 	2	34x135	300
RB1	 ROOFBEAMS-DACHBALKEN-DAKBALK	3	43x140	4000
R1	ROOFBOARD-DACHBRETT-DAKPLANK  or-oder-of	47+1 36+1	18x88 18x114	3000
GB1	GABLE BOARD-GIEBELBLLENDE-GEVELPLANK 	2	18x120	3100
GS1	ROOF FELT FILLET-GIEBELLEISTE-GEVELLIJST 	2	18x70	3100
EB1	EAVE BOARD-TRAUFBRETT-AFDEKPLANK 	2	18x90	4000
ES1	EAVE SLAT-TRAUFENLEISTE-AFDEKLIJST 	4	30x40	2000
SS1	STORM SLAT-STURMLEISTE-STORMLIJST 	2	18x35	1950
SS2	STORM SLAT-STURMLEISTE-STORMLIJST 	2	18x35	1800
	SCREWS-SCHRAUBEN-SCHROEF FOR-FÜR-VOOR SS1, SS2 	12	ø6.0	50
	WASHER-SCHEIBE-SCHIJF FOR-FÜR-VOOR SS1, SS2 	12	ø6.0	18
	NAIL-NAGEL-NAGEL FOR-FÜR-VOOR R1 	250	ø2.5	60
	SCREWS-SCHRAUBEN-SCHROEF FOR-FÜR-VOOR GB1, GS1, EB1, ES1 	60	ø4.5	50
	SCREWS-SCHRAUBEN-SCHROEF FOR-FÜR-VOOR RB1 	6	ø6.0	160
Kood	3402280 Sina 34	Materjal	File 3402280 Sina 34.dwg	Leht 7

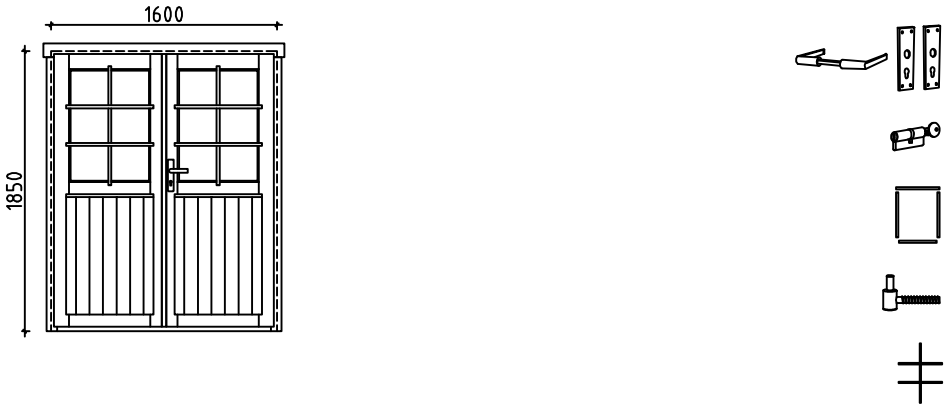
Pos	Specification-Bestimmung-Omschrijving 3402280 Sina 34	Pcs	Profile (mm)	L (mm)
	<p data-bbox="279 174 1157 206">DOUBLEDOOR-DOPPELTÜR-DUBBELE DEUR (right-rechts-rechts) AST_PL</p> 	<p data-bbox="1236 174 1252 206">P</p> <p data-bbox="1236 174 1252 206">1</p> <p data-bbox="1236 257 1252 288">1</p> <p data-bbox="1236 336 1252 367">1</p> <p data-bbox="1236 414 1252 445">1</p> <p data-bbox="1236 492 1252 524">6</p> <p data-bbox="1236 571 1252 602">2</p>	<p data-bbox="1348 174 1412 206">1600</p>	<p data-bbox="1460 174 1524 206">1850</p>
Kood	3402280 Sina 34	Materjal	File	8