

Caroline
Art. Nr. 4014800
1/13



15.02.2018

Art. Nr. 4014800

Groundplan - Grundplan - Plan de
masse - Planimetria - Plattegrond -
Põhiplan

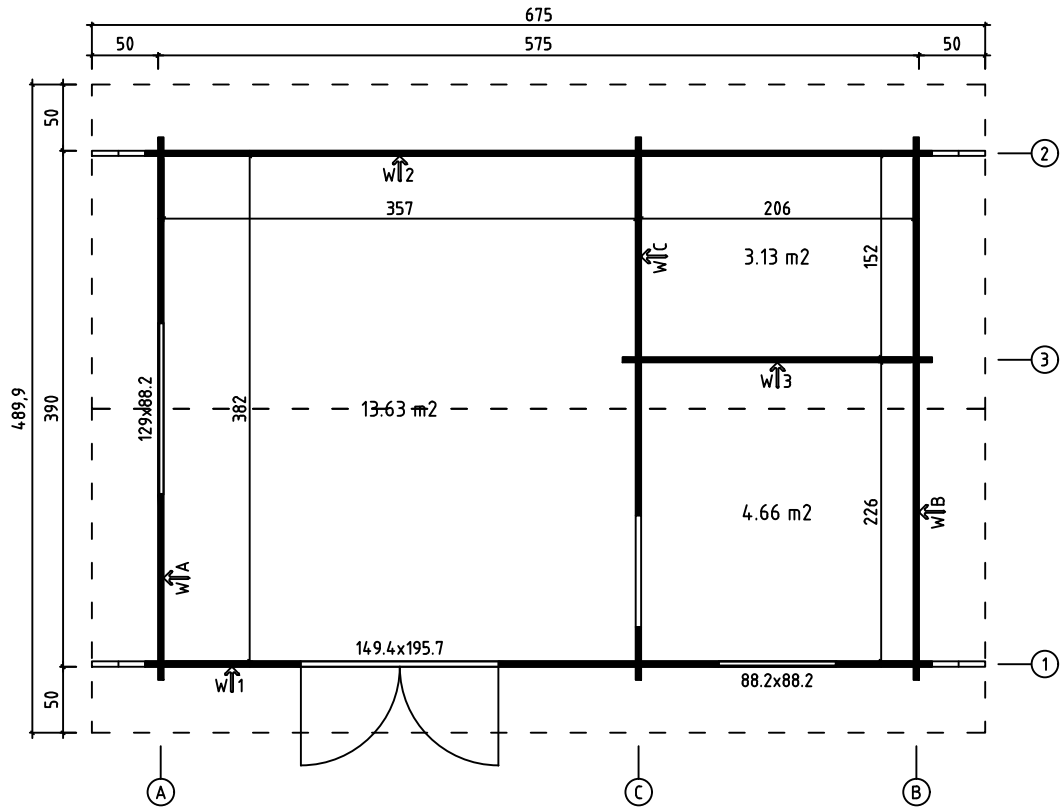

First floor plan - Grundplan für erste stock - Plan du premier etage

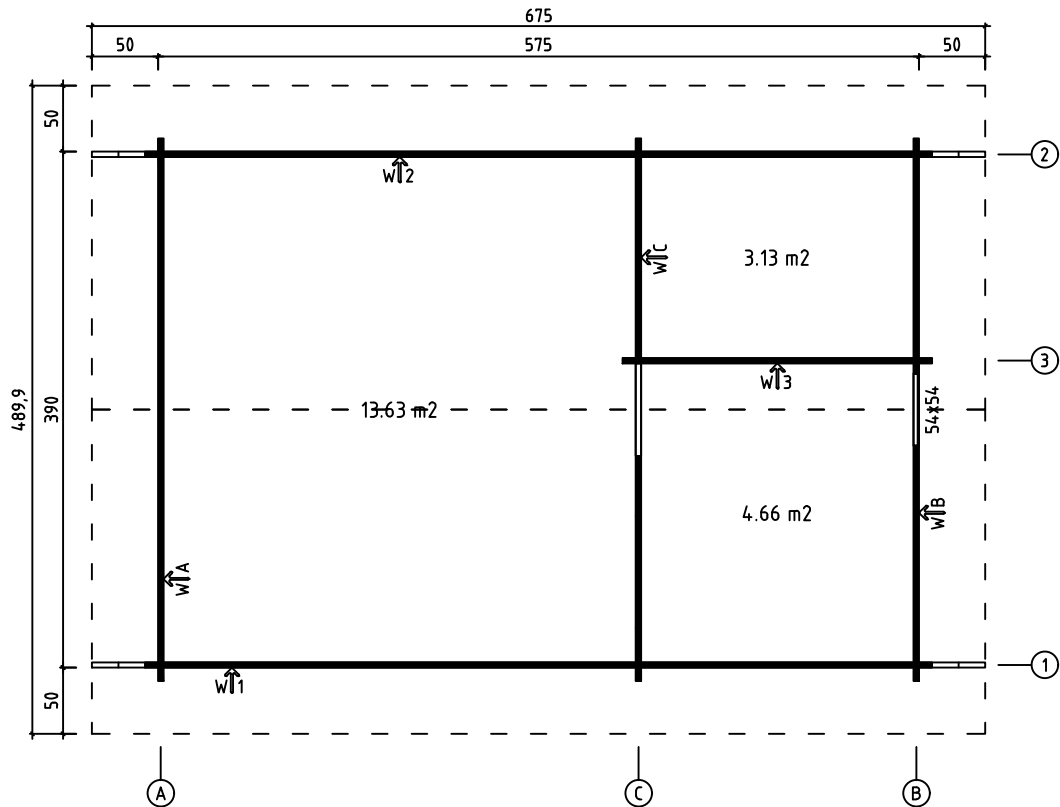

Art. Nr. 4014800

Foundation - Fundament - Fondation
- Fundamenta - Fundering -
Immutatud alusraam

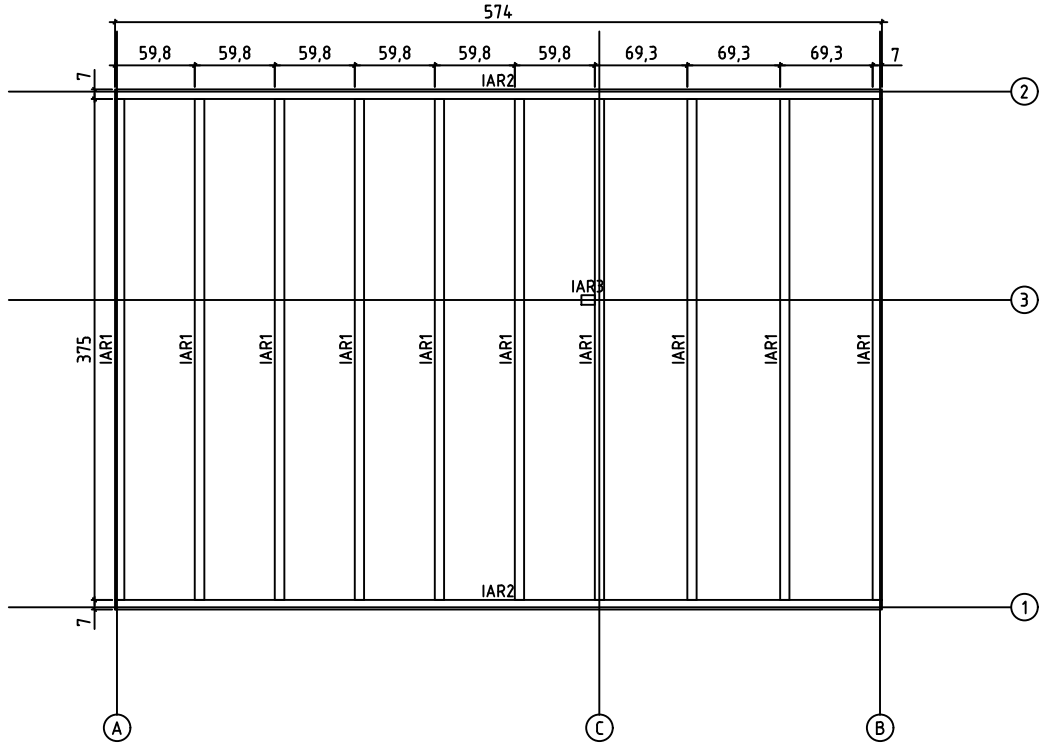

Mezzanine floor joists - Halbgeschoss balken -
Solives de plancher mezzanine - Travi del pavimento mezzanino -
Plaatduim scharnier - Laetlad

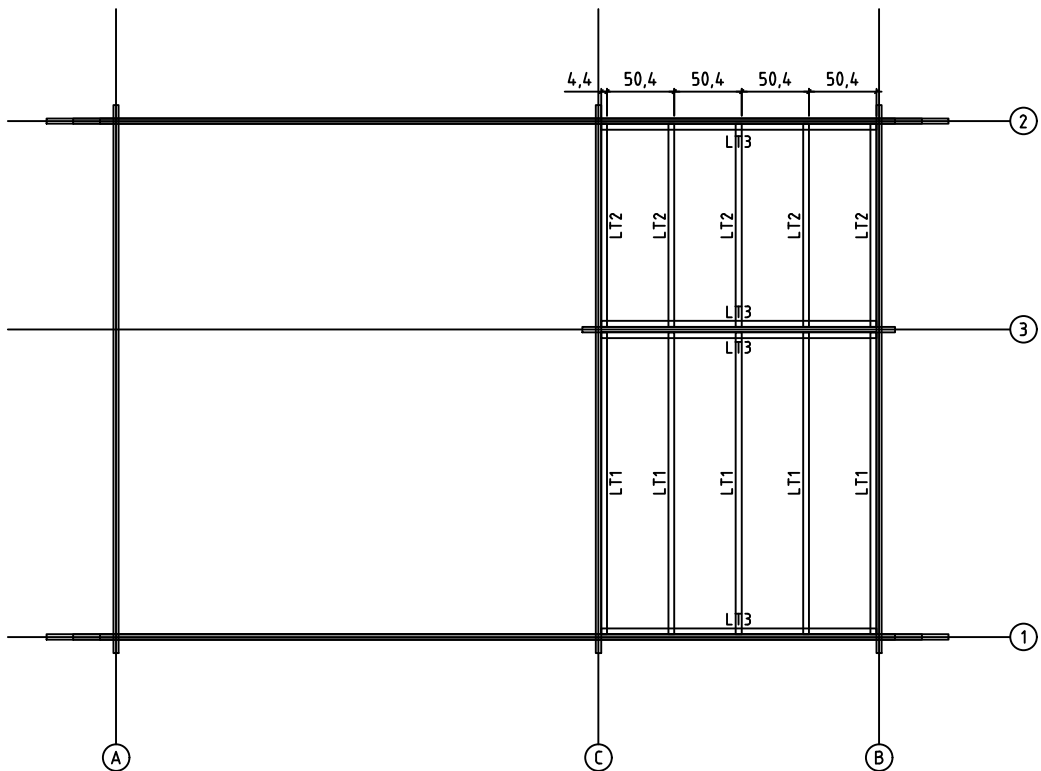

Art. Nr. 4014800

Floor boards - Fussbodenbretter -
Plan pose plancher - Pavimento -
Vloerhout - Põrandalaudis

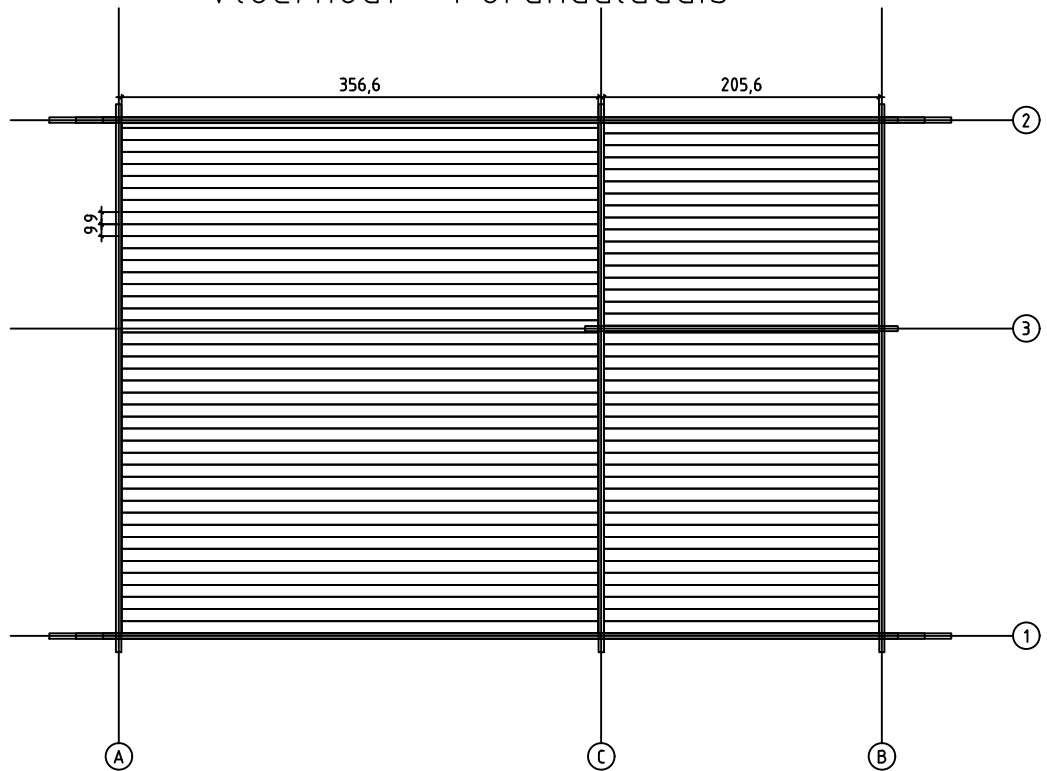

First floor floorboards - Fussbodenbretter für
erste stock - Plan pose plancher du premier etage

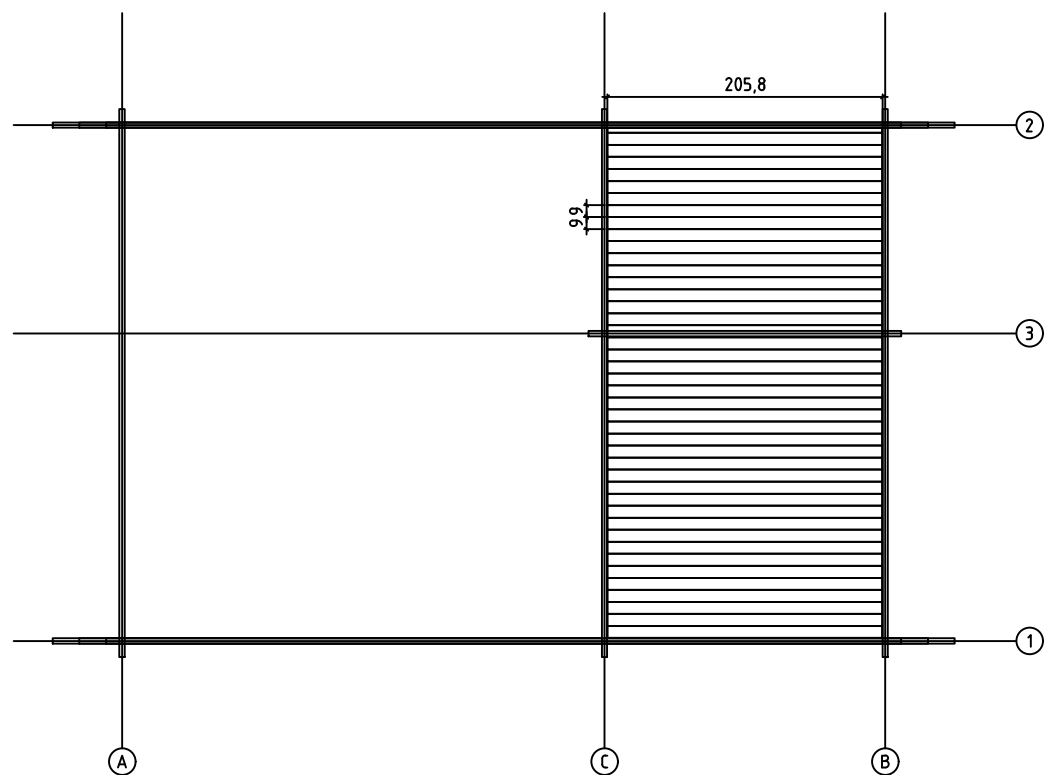

Art. Nr. 4014800

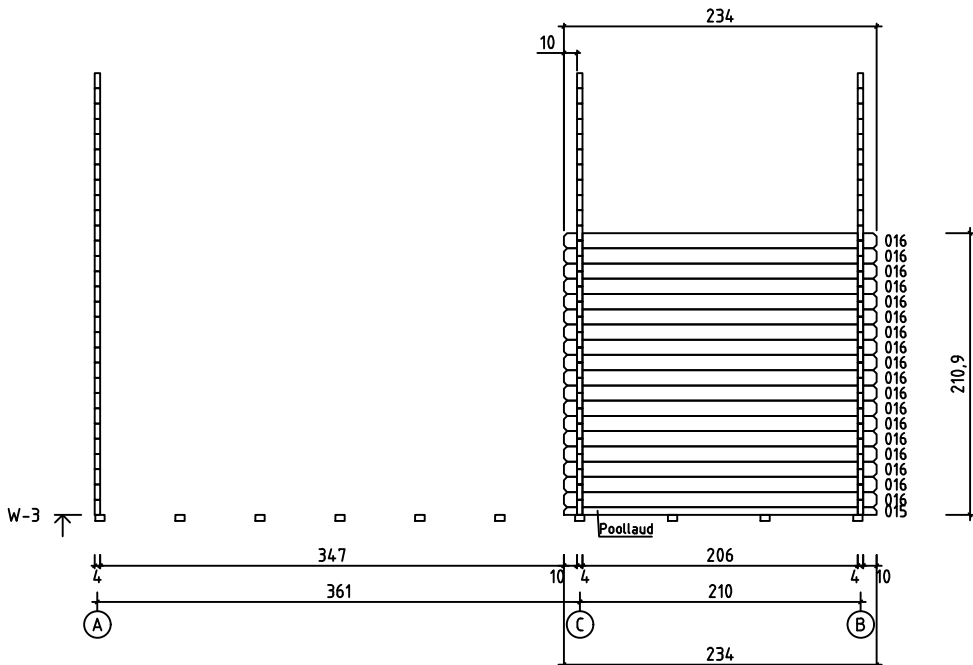
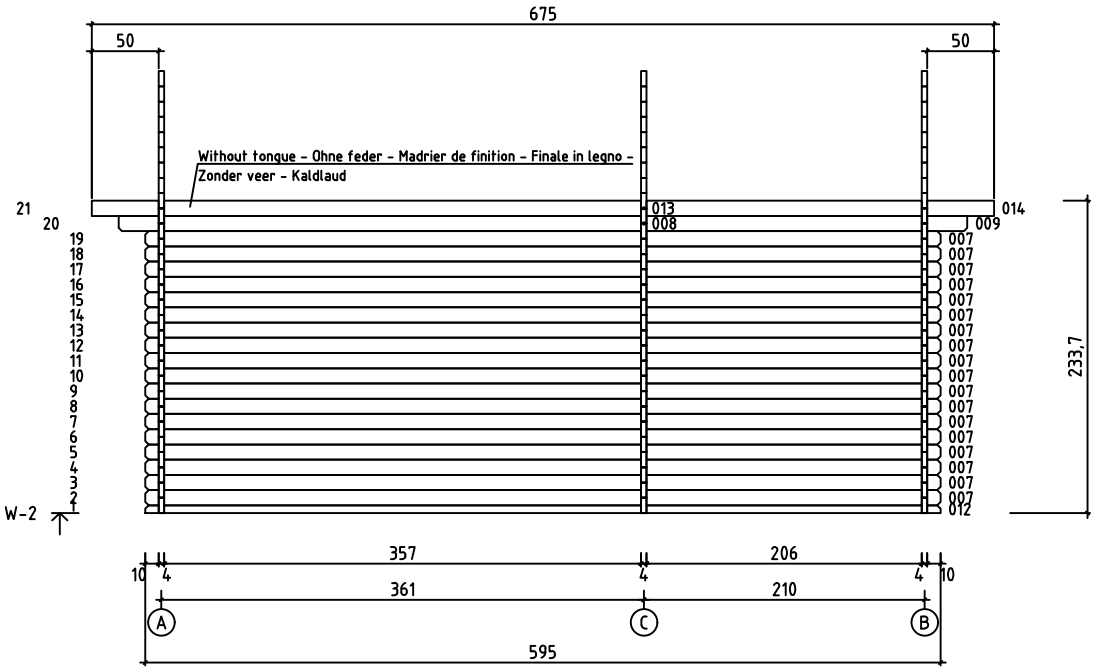
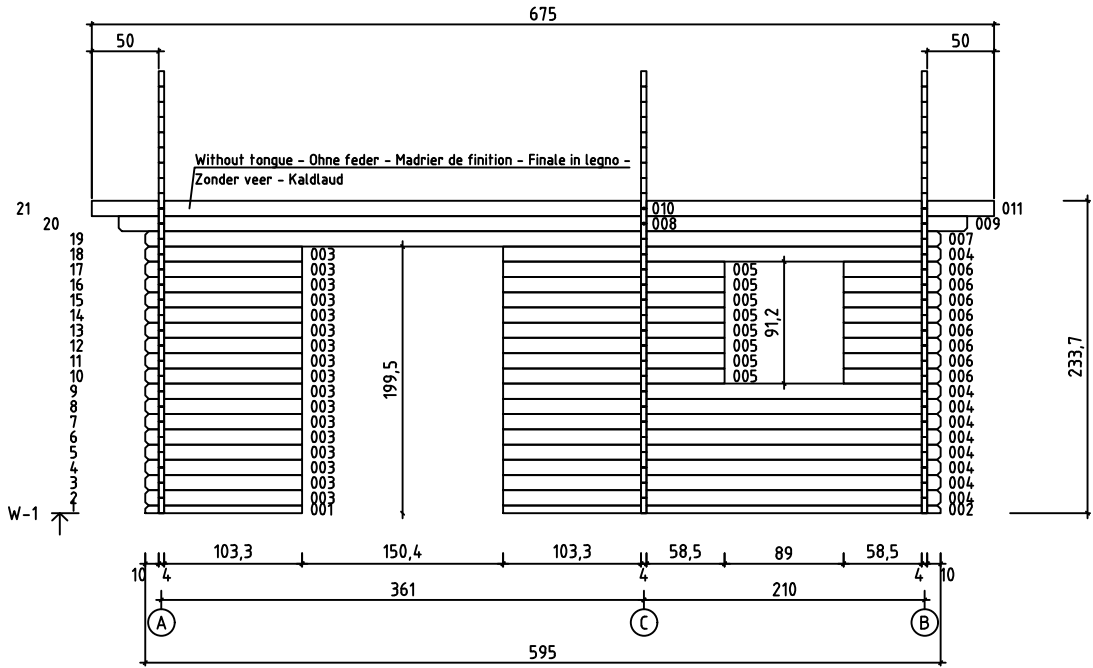

Art. Nr. 4014800

A single door (83.5x190 cm) has been delivered together with the building.
You can choose the location for the door by yourself by cutting the wall logs as shown in the picture (see the dotted line).

Eine Einzeltür (83.5 x 190 cm) ist im Lieferumfang enthalten. Über die Positionierung der Tür entscheiden Sie selbst, indem Sie den Ausschnitt für die Tür in Eigenregie einschneiden (siehe Bild unter der gestrichelten Linie).

Une porte simple (83.5x190 cm) est livree avec l'abri. Vous pouvez choisir l'endroit ou vous voulez monter la porte en decoupant les madriers tel qu'illustre dans le schema (voir ligne en pointilles).

Una porta singola (83.5x190 cm) é stata consegnata con la casa. Tu puoi scegliere la posizione della porta secondo il tuo gradimento. tagliando la parete come raffigurato nella fotografia (segui la linea tratteggiata).

Bij uw huisje is een losse enkele deur (83.5x190 cm) geleverd. U heeft hierin een vrije keuze waar u deze wilt inbouwen, door het inzagen van de wandbalk zoals op de tekening (zie de stippellijn).

Majakomplekt sisaldab üksikut (83.5x190 cm), mille asukoht on võimalik ise valida. Ukseava tuleb lõigata joonisel näidatud mõõtudes (vaadake punktiirjooni).

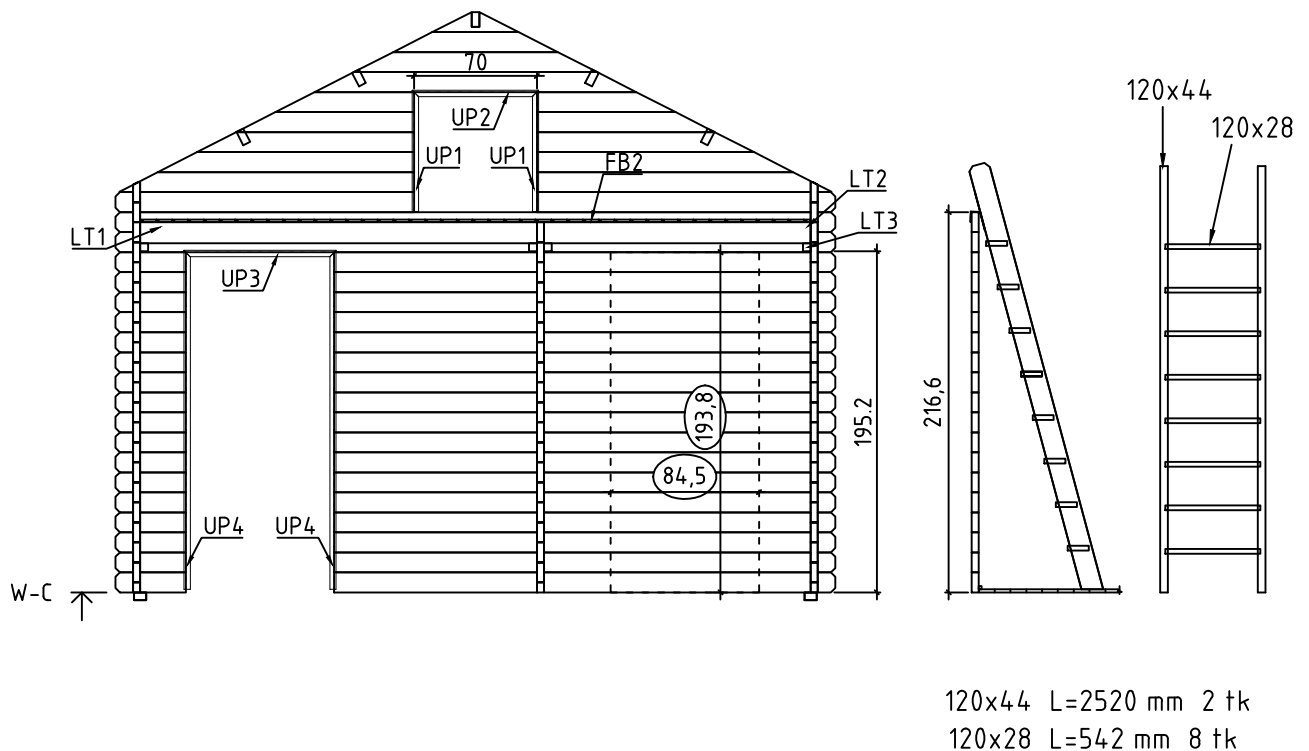

4014800

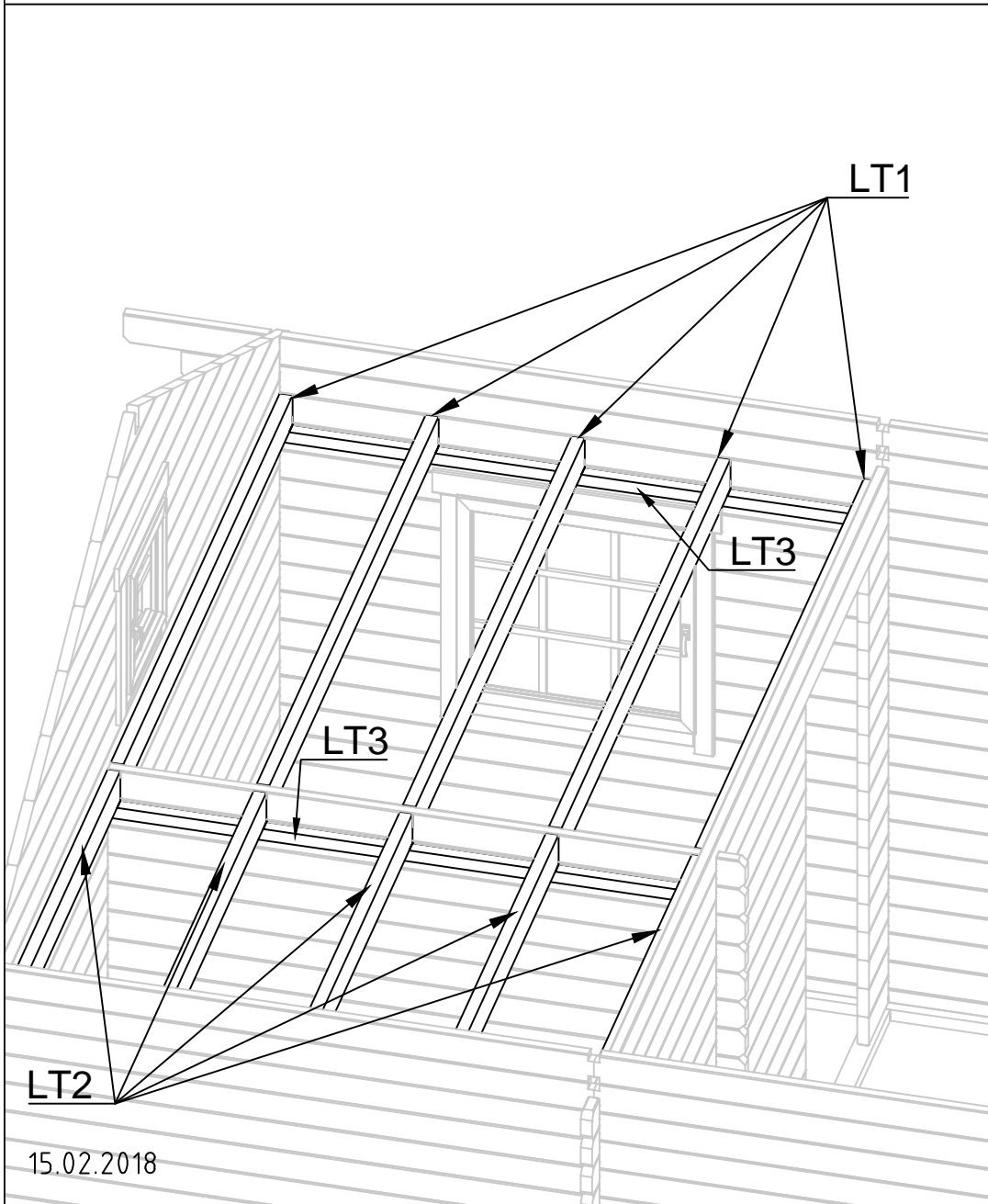

LT2

LT1

LT3

LT3

15.02.2018

1

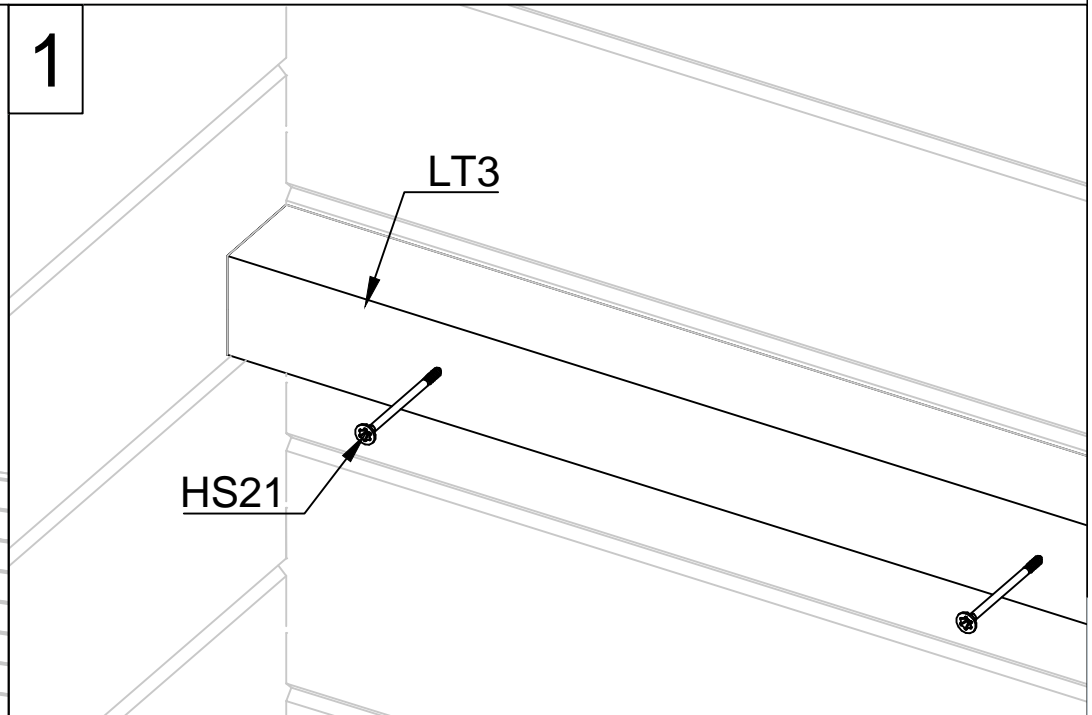

LT3

HS21

2

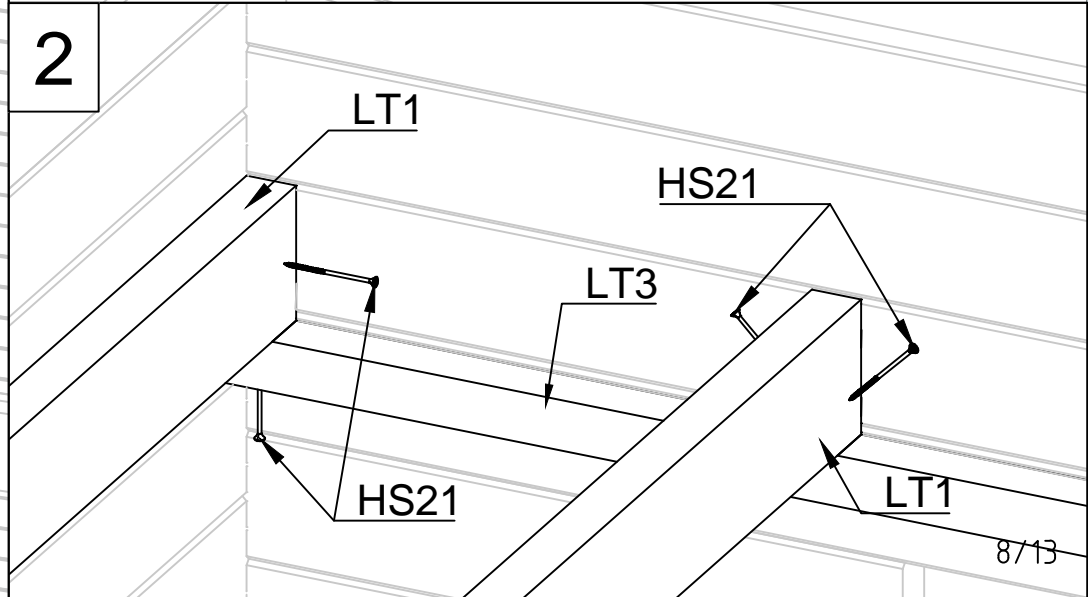

LT1

HS21

LT3

HS21

LT1

8/13

1

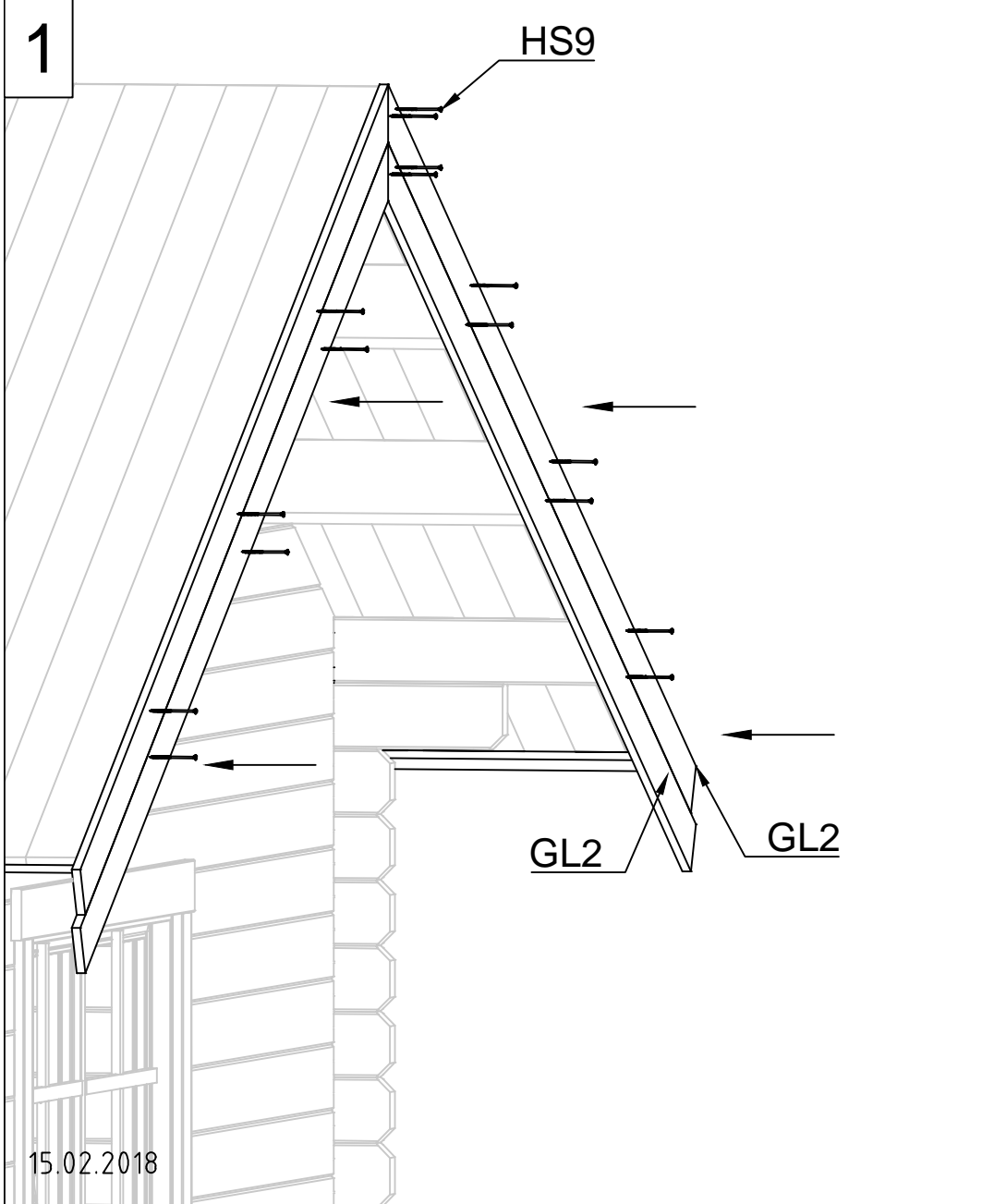





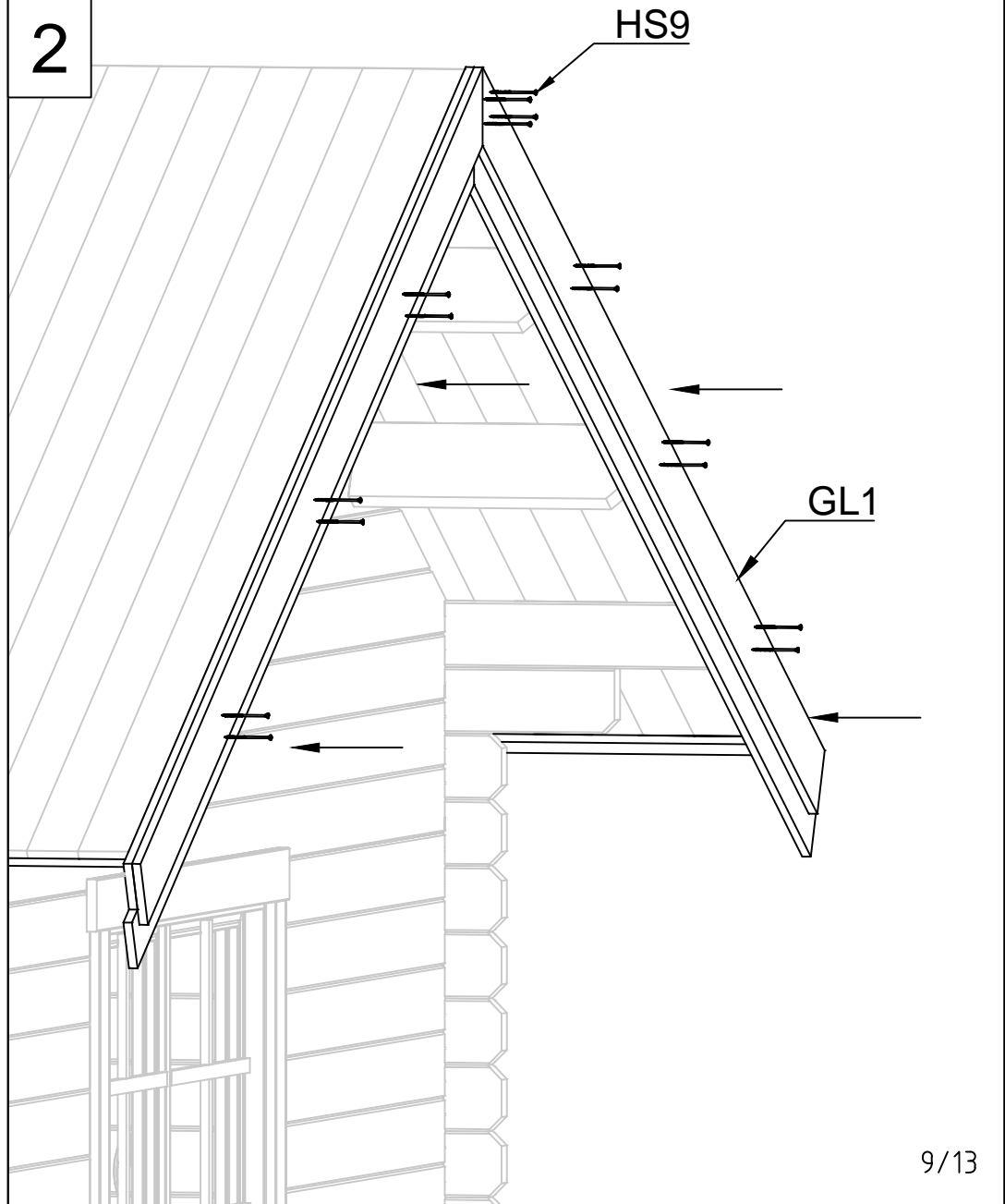



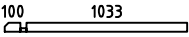
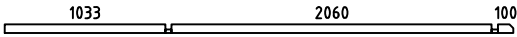
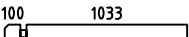
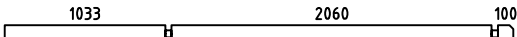
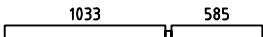
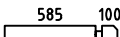
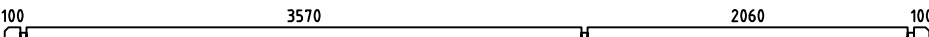
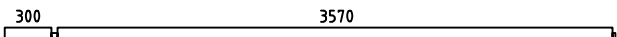
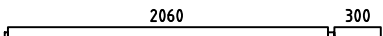
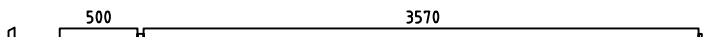
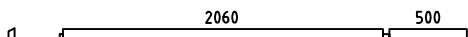

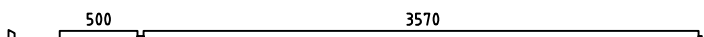
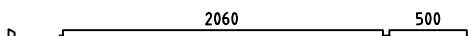
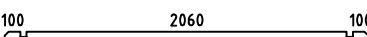
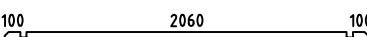
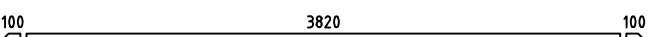
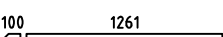
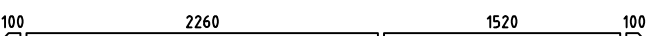
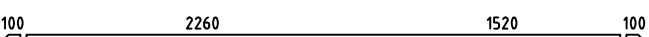

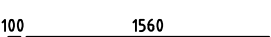

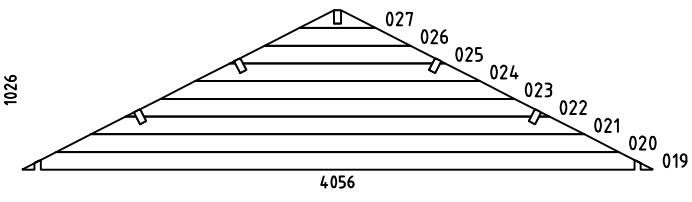
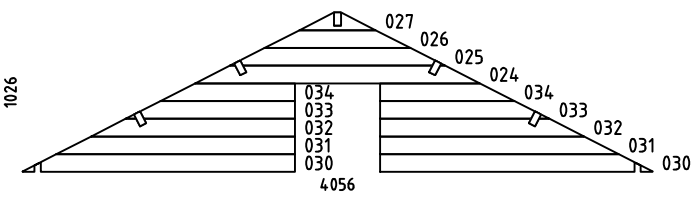
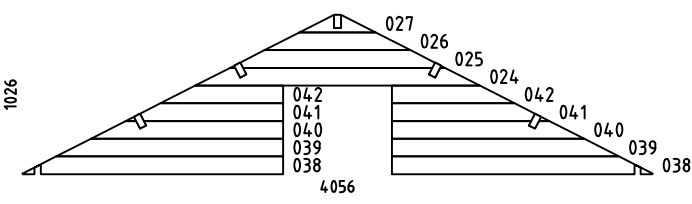
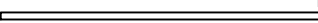
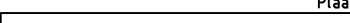
15.02.2018

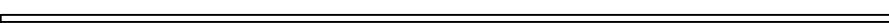
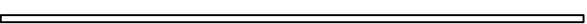

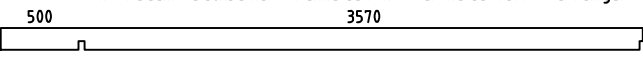
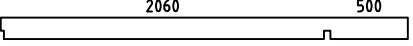

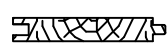









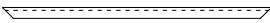
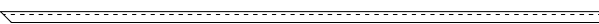

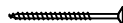
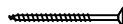



2



9/13



Pos	15.02.2018 Piece list - Stückliste - Liste des pièces - Elementi - Stuklijst - Tükítabel Art. Nr. 4014800 10/13	Q	P (mm)	L (mm)
001		1	40x57	1173
002		1	40x57	3273
003		17	40x114	1173
004		9	40x114	3273
005		8	40x114	1658
006		8	40x114	725
007		19	40x114	5950
008		2	40x114	3930
009		2	40x114	2420
010		1	40x120	4130
011		1	40x120	2620
012		1	40x57	5950
013		1	40x120	4130
014		1	40x120	2620
015		1	40x57	2340
016		18	40x114	2340
017		13	40x114	4100
018		16	40x114	1401
028		19	40x114	4100
029		2	40x114	4100
035		17	40x114	400
036		17	40x114	2855
037		2	40x114	1700



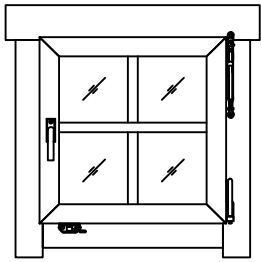
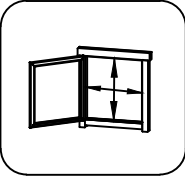
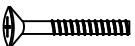
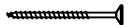

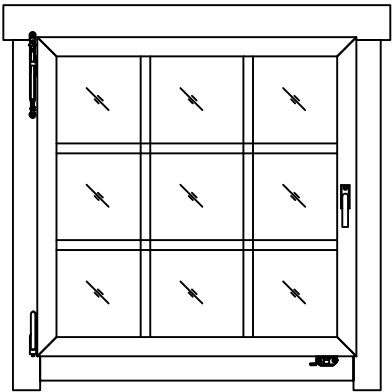
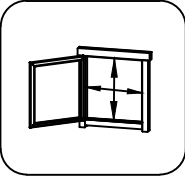
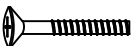
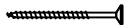

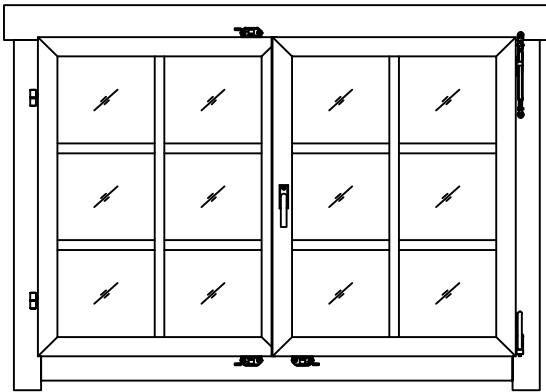
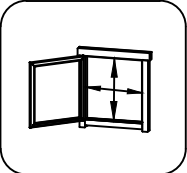
Pos	15.02.2018 Piece list - Stückliste - Liste des pièces - Elementi - Stuklijst - Tükitalabel Art. Nr. 4014800 11/13	Q	P (mm)	L (mm)
WA-1		1		
WB-1		1		
WC-1		1		
LT3	Mezzanine floor joists - Halbgeschoss balken - Solives de plancher mezzanine - Travi del pavimento mezzanino - Plaatduim scharnier - Laetalad 	4	45x45	2060
LT1	Mezzanine floor joists - Halbgeschoss balken - Solives de plancher mezzanine - Travi del pavimento mezzanino - Plaatduim scharnier - Laetalad 	5	44x120	2260
LT2	Mezzanine floor joists - Halbgeschoss balken - Solives de plancher mezzanine - Travi del pavimento mezzanino - Plaatduim scharnier - Laetalad 	5	44x120	1520
IAR2	Foundation - Fundament - Fondation - Fondamenta - Fundering - Immutatud alusraam 	2	70x45	5740
IAR1	Foundation - Fundament - Fondation - Fondamenta - Fundering - Immutatud alusraam 	10	70x45	3750
IAR3	Foundation - Fundament - Fondation - Fondamenta - Fundering - Immutatud alusraam 	1	70x45	100
A-PR1	Roof beam - Dachbalken - Panne de toit - Perlina del tetto - Gordingen / dakbalk - Pärilin 	5	44x140	4130
A-PR2	Roof beam - Dachbalken - Panne de toit - Perlina del tetto - Gordingen / dakbalk - Pärilin 	5	44x140	2620
FB1	Floor boards - Fussbodenbretter - Lame de plancher - Pavimento - Vloerhout - Pörandalaud 	43	90x15	3566
FB2	Floor boards - Fussbodenbretter - Lame de plancher - Pavimento - Vloerhout - Pörandalaud 	86	90x15	2056
	Roof boards - Dachbretter - Voliges - Perlina per tetto - Dakhout - Katuselaud 	150	90x15	2750
	Floor fillet - Fussbodenleiste - Corniere de finition du plancher - Finitura per pavimento (battisco pa) - Vloerafwerklijs - Pörandaliist 		18x18	42.28
	Roofing felt fillet - Dachpappenleiste - Baguette de fixation du feutre bitumeux - Asse per fissaggio guaina bituminosa - Afdeklijs asfaltpapier - Katusepapiliist 	4	15x45	2800
	Doorstep - Swelle - Seuil de porte - Callare - Drempeel - Lävepakk ukseavale 	1	18x44	845

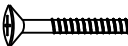
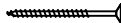
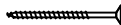

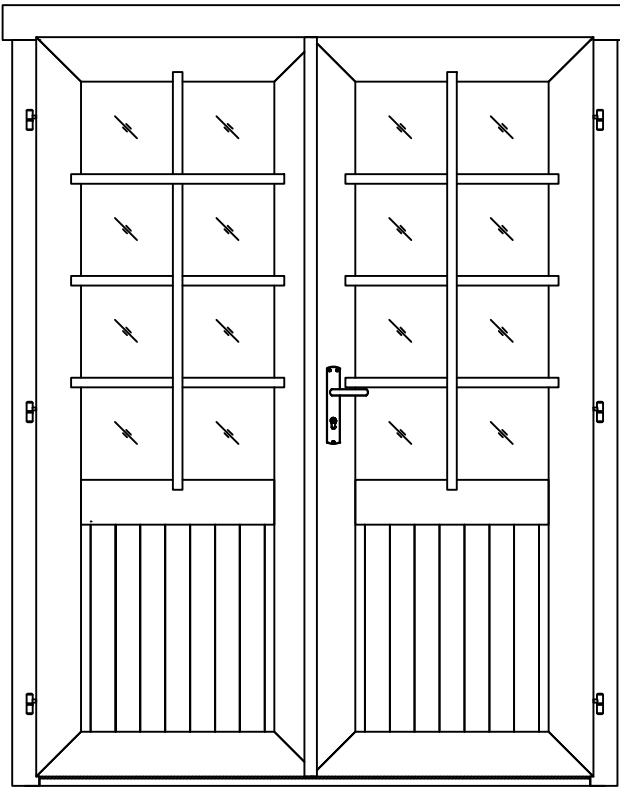
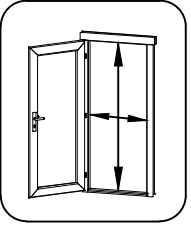
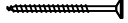
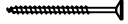
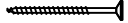

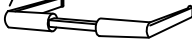
Pos	15.02.2018 Piece list - Stückliste - Liste des pièces - Elementi - Stuklijst - Tükitalabel Art. Nr. 4014800	12/13	Q	P (mm)	L (mm)
DRV-1	Roof edge reinforcement - Dachrandverstärkung - Corniere de renfort de bord de toit - Rinforzo x tetto - Dakrand versterking - Räästatugevdus 		4	15x45	3375
KFS-1	Storm protection - Sturmleiste - Latte anti-tempete - Protezione anti vento - Stormverankering / beveiliging - Tormikinnitusliist 		6	22x45	2500
	U-profile - U-profils - Profile u - Profilo ad u - U-profiel - U-profiil 		2	35x70	690
	U-profile - U-profils - Profile u - Profilo ad u - U-profiel - U-profiil 		1	35x70	720
	U-profile - U-profils - Profile u - Profilo ad u - U-profiel - U-profiil 		1	35x70	865
	U-profile - U-profils - Profile u - Profilo ad u - U-profiel - U-profiil 		2	35x70	1930
GL1	Gable moulding - Giebelleiste - Planche de rive - Finitura per frontale e retro del tetto - Gevellijst - Viilulaud 		4	15x120	2800
GL2	Gable moulding - Giebelleiste - Planche de rive - Finitura per frontale e retro del tetto - Gevellijst - Viilulaud 		8	15x90	2800
HS8	Screw for gable segment - Schrauben für deckblatt - Vis pour fixation losange de finition - Viti x frontali tetto - Schroef voor gevelpunt segment - Kruvi rombile 		4	3.5x35	
HS9	Screw for gable moulding - Schrauben für giebelleiste - Vis pour fixation planche de rive - Vite per fissare finiture davanti e dietro del tetto - Schroef voor gevellijst - Kruvi viilulauale 		64	3.5x50	
HS4	Screw for doorstep - Schrauben für swelle - Vis pour fixation barre de seuil - Vite per soglia della porta - Schroef voor deurdeurpakule 		3	3x30	
HS4	Screw for roof edge reinforcement - Schrauben für dachrandverstärkung - Vis pour fixation corniere renfort de bord de toit - Viti x rinforzo bordo tetto - Schroef voor dakrand versterking - Kruvi räästatugevdusele 		32	3x30	
HS12	Screw for universal hook - Schrauben für universalhaken - Vis pour crochets universels - Vite per gancio universale - Schroef voor universele haak - Kruvi redeli fiksaatorile 		4	4x40	
HS13	Screw for u-profile - Schraube zur befestigung u-profils - Vis a tete fraisée pour profil u - Vite per profilo ad u - Schroef ter bevestiging u-profiel - Kruvi U-profiilile 		12	4x60	
HS13	Screw for stepladder - Schraube für leiter - Vis d'assemblage des marches de l'échelle - Vite per scaletta - Schroef voor trapladder - Kruvi redeli montaažiks 		34	4x60	
HS18	Screw for foundation - Schrauben zur befestigung fundament - Vis de fixations des poutrelles de fondations - Viti x fondamenta - Schroef voor fundering - Kruvi alusraamile 		20	5x120	
HS18	Screw for roof beams - Schrauben für dachbalken - Vis pour fixation pannes de toit - Viti per perline del tetto - Schroef voor gordingen / dakbalken - Kruvi pärlinitete 		20	5x120	
HS18	Screw for wall details - Schraube für wand details - Vis pour mur details - Viti per elementi della porta - Schroef voor wand details - Kruvi seinadetailidele 		8	5x120	
HS18	Screw for gable - Schrauben für giebel - Vis pour fixation des pignons - Viti per timpano - Schroef voor gevelpunt - Kruvi viilude kinnitamiseks 		6	5x120	
HS16	Screw for 1. wall beam - Schraube für 1. bohlenreihe - Vis de fixations 1ere rangée de madriers avec poutrelles de fondations - Vite fissaggio alle fondamenta - Schroef voor 1 wandbalk - Kruvi poollauale 		8	5x90	
HS21	Screw for beam - Schrauben zur befestigung dachsparren - Vis pour solive - Viti per perline - Schroef voor balk (gording) - Kruvi talale 		68	6x80	
NF2	Zn nail for floor fillet - Zn nagel für fussbodenleiste - Pointe pour corniere de finition du plancher - Chiodi x fissaggio pavimento - Spijker(nagel) voor vloer afdekljst - Nael põrandaliistule 		128	1.4x40	
SH40	Hammer block - Schlagholz - Calle de frappe - Blocco di legno da usare come cuscinetto quando si usa il martello - Slagklos - Löögiklots 		1		

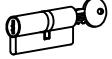
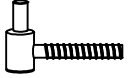
Pos	23.11.2017 Piece list - Stückliste - Liste des pièces - Elementi - Stuklijst - Tükitalabel 540x540 AK.1.104.TSSP.d SGC	1/1	Q	P (mm)	L (mm)
	<p data-bbox="263 152 1284 183">Glass size - Glasgröße - Taille de la vitre - Misura del vetro - Glas afmeting - Klaasi mõõt: 396x396 mm</p> <div data-bbox="730 241 991 501" style="text-align: center;">  </div> <div data-bbox="1337 152 1522 327" style="text-align: right;">  <p data-bbox="1369 349 1490 376">440x440 mm</p> </div>				
FS1	Window handle fittings - Fenstergriff - Poignee de fenetre - Maniglia c/ferramenta - Raamhendel -/grendel -/klink - Aknalink		1		
FSP	Bolt for window handle fittings - Bolzen für fenstergriff beschlag - Vis pour fixation poignee de fenetre - Bullone x apertura manuale finestra - Schroef voor raamhendel - Akna käepideme polt		2		
HS1	Screw for georgian bars - Schraube für sprossen - Vis pour croisillons - Viti per unire la griglia georgiana della finestra - Schroeven voor raamverdeling - Kruvi akna petfeliistule		4	2.5x20	

Pos	02.01.2018 Piece list - Stückliste - Liste des pièces - Elementi - Stuklijst - Tükítabel 882x882 AK.1.109.TSSV.b SGC	1/1	Q	P (mm)	L (mm)
	<p data-bbox="261 152 1283 181">Glass size - Glasgröße - Taille de la vitre - Misura del vetro - Glas afmeting - Klaasi mõõt: 738x738 mm</p>   <p data-bbox="1369 349 1490 378">782x782 mm</p>				
FS1	Window handle fittings - Fenstergriff - Poignée de fenetre - Maniglia c/ferramenta - Raamhendel -/grendel -/klink - Aknalink		1		
FSP	Bolt for window handle fittings - Bolzen für fenstergriff beschlag - Vis pour fixation poignée de fenetre - Bullone x apertura manuale finestra - Schroef voor raamhendel - Akna käepideme polt		2		
HS1	Screw for georgian bars - Schraube für sprossen - Vis pour croisillons - Viti per unire la griglia georgiana della finestra - Schroeven voor raamverdeling - Kruvi akna petfeliistule		8	2.5x20	

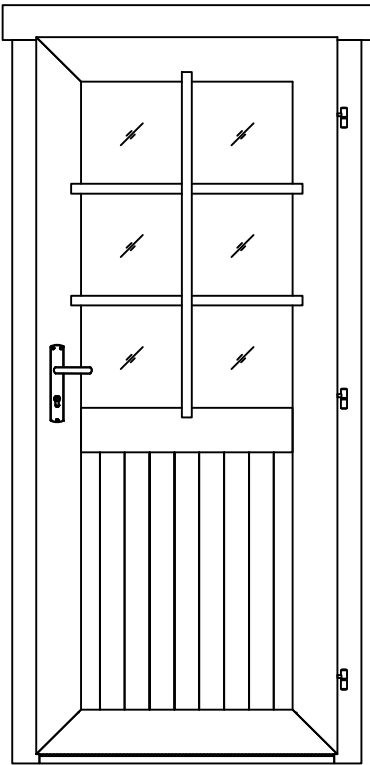
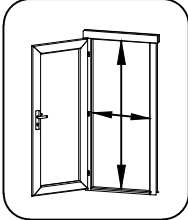
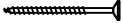
Pos	Piece list - Stückliste - Liste des pièces - Elementi - Stuklijst - Tükitalabel 1290x882 TAK.1.106.TSSP.a SGC	1/1	Q	P (mm)	L (mm)
	<p data-bbox="258 152 1284 183">Glass size - Glasgröße - Taille de la vitre - Misura del vetro - Glas afmeting - Klaasi mõõt: 542x738 mm</p>   <p data-bbox="1369 347 1492 376">1190x782 mm</p>				
FS1	Window handle fittings - Fenstergriff - Poignee de fenetre - Maniglia c/ferramenta - Raamhendel -/grendel -/klink - Aknalink		1		
FSP	Bolt for window handle fittings - Bolzen für fenstergriff beschlag - Vis pour fixation poignee de fenetre - Bullone x apertura manuale finestra - Schroef voor raamhendel - Akna käepideme polt		2		
HS1	Screw for georgian bars - Schraube für sprossen - Vis pour croisillons - Viti per unire la griglia georgiana della finestra - Schroeven voor raamverdeling - Kruvi akna petteliistule		12	2.5x20	
HS4	Screw for window fillet - Schraube für glasteile - Vis de filet de fenetre - Vite per assemblaggio finestra - Schroef voor glaslijst - Kruvi akna kokkuvaltšiliistule		3	3x30	

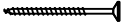
Pos	02.01.2018	Piece list - Stückliste - Liste des pièces - Elementi - Stuklijst - Tükítabel 14 94x1957 TUK.2.068.TSVP.MMd SGC	1/1	Q	P (mm)	L (mm)
		Glass size - Glasgröße - Taille de la vitre - Misura del vetro - Glas afmeting - Klaasi mõõt: 514x1041 mm				
		  <p>1394x1875 mm</p>				
HS1	Screw for georgian bars - Schraube für sprossen - Vis pour croisillons - Viti per unire la griglia georgiana della finestra - Schroeven voor raamverdeling - Krugi ukse peffeliistule		16	2.5x20		
HS4	Screw for door fillet - Schraube zur befestigung türleiste - Vis pour fixation baguette d'arret de porte - Viti per massellino della porta - Schroef voor deurlijst - Krugi ukse kokkuvaltsiliistule		5	3x30		
HS16	Screw for door jamb - Schraube für türrahmen - Vis de fixation partie haute avec montants du cadre de porte - Viti x fissaggio montanti porte - Schroef voor deurkozijn - Krugi ukse lengile		4	5x90		
HS25	Screw for doorstep - Schrauben für swelle - Vis pour fixation barre de seuil - Vite per soglia della porta - Schroef voor deurdorpel - Krugi lävepakule		3	4.5x65		
TL4	Door handle fittings - Türgriff - Poignee de porte - Maniglie - Deurhendel / klink - Ukse käepide VU		1			
TL5	Set of door lock covers - Schlossblenden - Set de garnitures de porte - Copertura serrature - Slot sluitplaat set - Ukse lukuplaat		1			
	Cylinder lock - Zylinderschloss - Barillet de porte - Serratura - Cylinder slot - Ukse lukusüdamik		1			
	Male bolt hinge for door - Türband - Partie male de paumelle de porte - Cerniera anube x porta - Scharnier bout - Ukse polthing isane		6			
	Striker for barrel bolt - Hülse für grendelriegel - Gache au sol du targette - Boccola per fermo della porta - Huls voor vergrendelingsschuif - Vasturaud ukse servariivile		2			

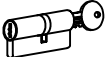
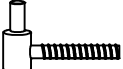
Pos	14.11.2017	Piece list - Stückliste - Liste des pièces - Elementi - Stuklijst - Tükítabel 835x1900 UK.2.056.TSVP.MMd SGC	1/1	Q	P (mm)	L (mm)
		Glass size - Glasgröße - Taille de la vitre - Misura del vetro - Glas afmeting - Klaasi mõõt: 561x855 mm				
		  <p>735x1818 mm</p>				
HS1		Screw for georgian bars - Schraube für sprossen - Vis pour croisillons - Viti per unire la griglia georgiana della finestra - Schroeven voor raamverdeling - Kruvi ukse petteliistule		6	2.5x20	
HS16		Screw for door jamb - Schraube für Türrahmen - Vis de fixation partie haute avec montants du cadre de porte - Viti x fissaggio montanti porte - Schroef voor deurkozijn - Kruvi ukse lengile		4	5x90	
HS25		Screw for doorstep - Schrauben für swelle - Vis pour fixation barre de seuil - Vite per soglia della porta - Schroef voor deurdorpel - Kruvi lävepakule		2	4.5x65	
TL4		Door handle fittings - Türgriff - Poignée de porte - Maniglie - Deurhendel / klink - Ukse käepide VU		1		
TL5		Set of door lock covers - Schlossblenden - Set de garnitures de porte - Copertura serrature - Slot sluitplaat set - Ukse lukuplaat		1		
		Cylinder lock - Zylinderschloss - Barillet de porte - Serratura - Cylinder slot - Ukse lukusüdamik		1	30x35	
		Male bolt hinge for door - Türband - Partie male de paumelle de porte - Cerniera anube x porta - Scharnier bout - Ukse polthing isane		3		