

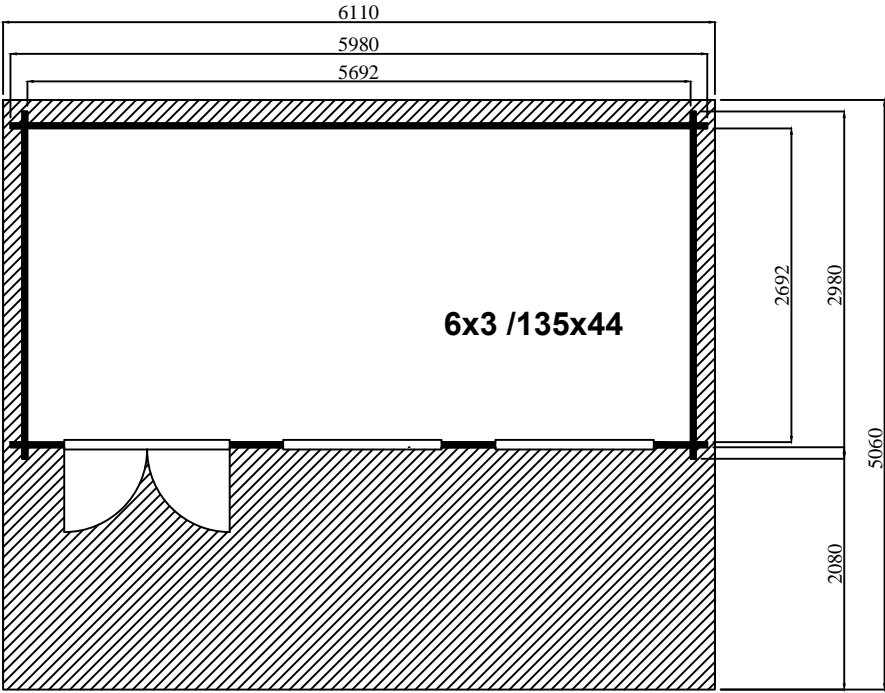

# AUFBAUANLEITUNG SAAR 1

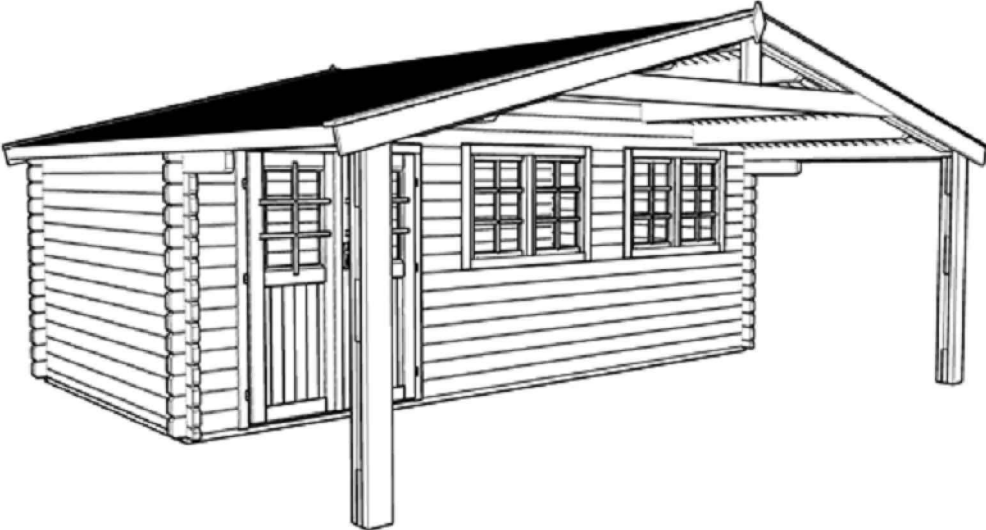





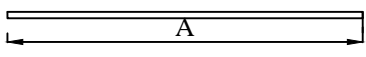
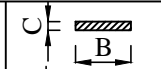
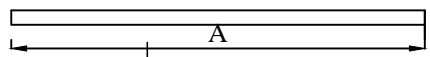
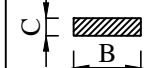

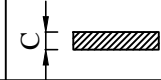
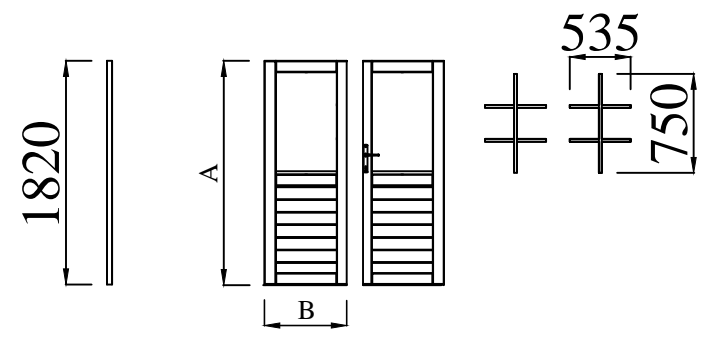
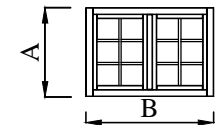
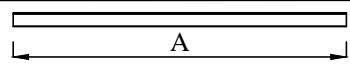
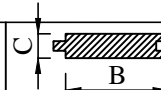
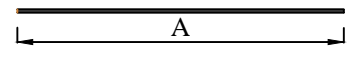
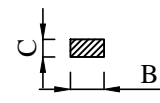

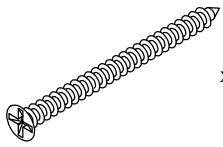
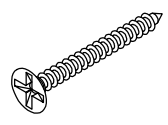
SAAR 1

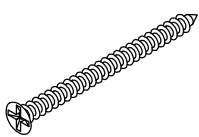
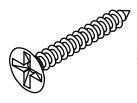
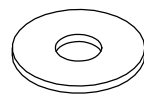
Nr.	Menge	Abmessungen, mm			Details
		A	B	C	
1.1	x 3	3780	60	40	
1	x 12	2800	60	40	
B1	x 14+1	5980	135	44	
C1	x 2	2980	68	44	
C2	x 24	2980	135	44	
A2	x 7	4100	135	44	
A3	x 21	460	135	44	
A4	x 14	460	135	44	
C4	x 2	3480	135	44	
C3	x 1+1	4980	135	44	
Sp1	x 6	4980	140	44	
Sp2	x 1	4980	140	44	
Wp1	x 2	5980	671	44	
Wp2	x 1	5980	751	80	
Pf	x 2	1870	120	120	
TR1	x 1	1494	82	90	
TR2	x 2	1860	75	82	
TR3	x 1	1320	44	40	
Db	x 116+2	3120	88	18	
Wb1	x 4	3170	90	19	
Wb2	x 4	3170	60	19	

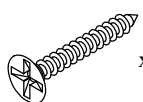
SAAR 1

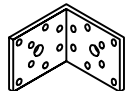
L1	x 6	1685	40	16		
L2	x 4	2530	60	19		
D	x 2	200	100	19		
T1 T2	1+1	1820	665	40		
F1	x 2	1035	1410			
Bb	x 65+2	2680	88	18		
BL	x 6	1897	28	19		
BL	x 4	1345	28	19		

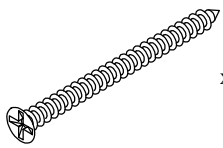
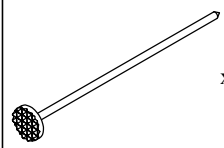
5 x 90	4 x 40	09 13 GZN	501/33Fe/HME
 x 12	 x 152	 x 6	 x 4
5 x 70 mm	3 x 30	M8	AH9213
 x 4	 x 80	 x 8	 x 1
3 x 20 mm	7,5 x 92		US-40-01
 x 12	 x 8	 x 24	 x 2
6 x 120 mm	2 x 40 mm		
 x 18	 x 1030		

# SAAR 1

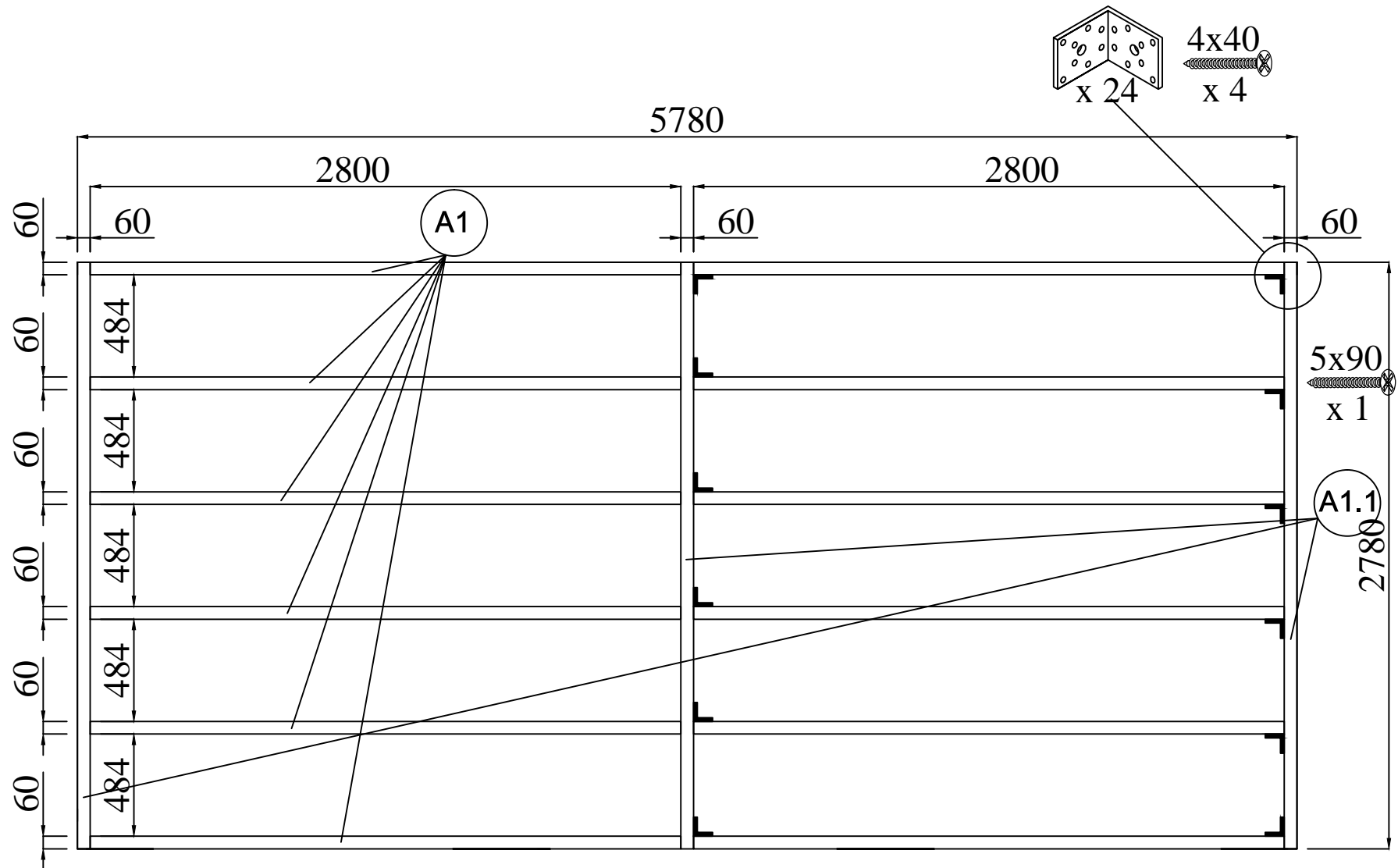

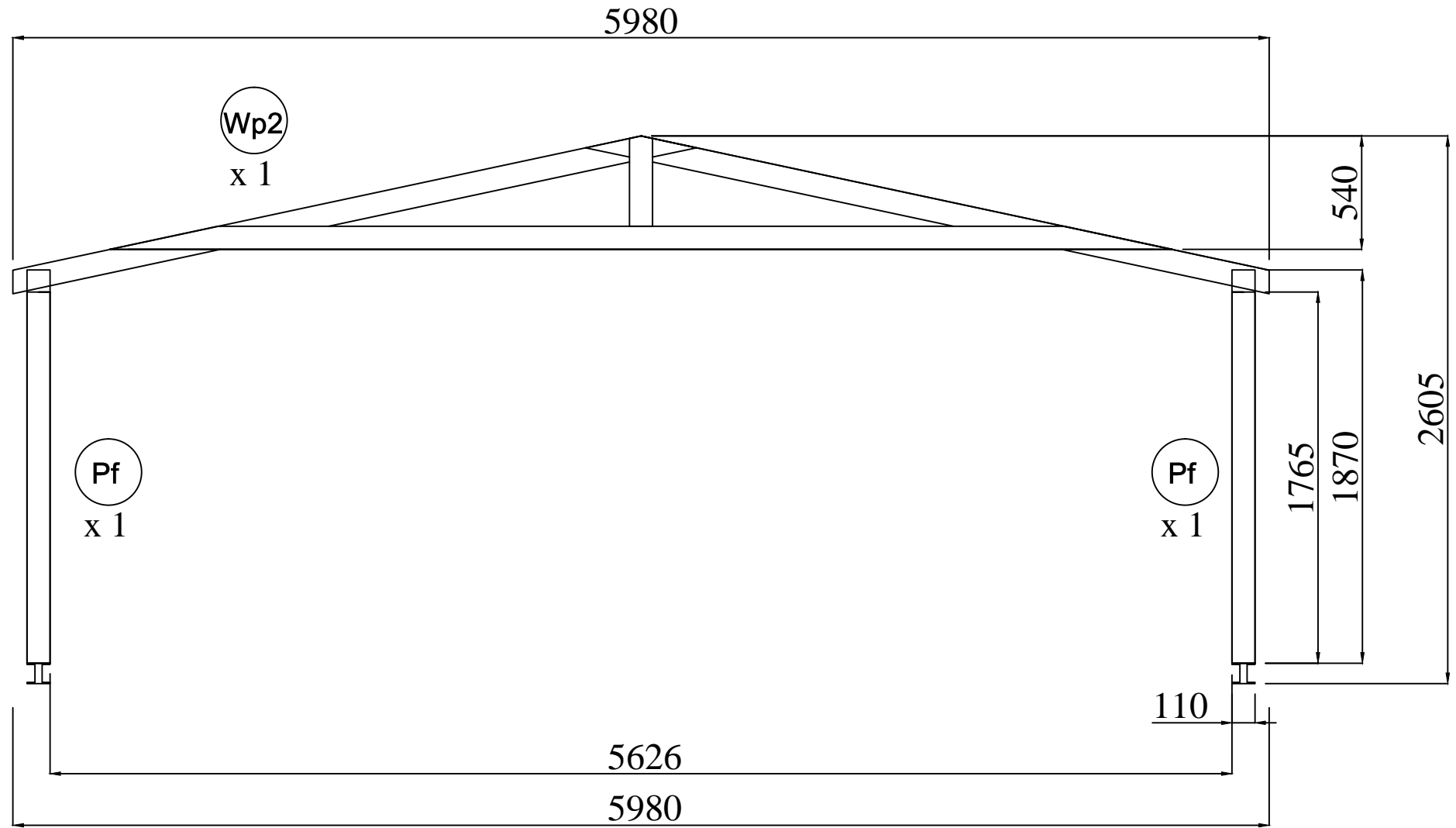

# SAAR 1

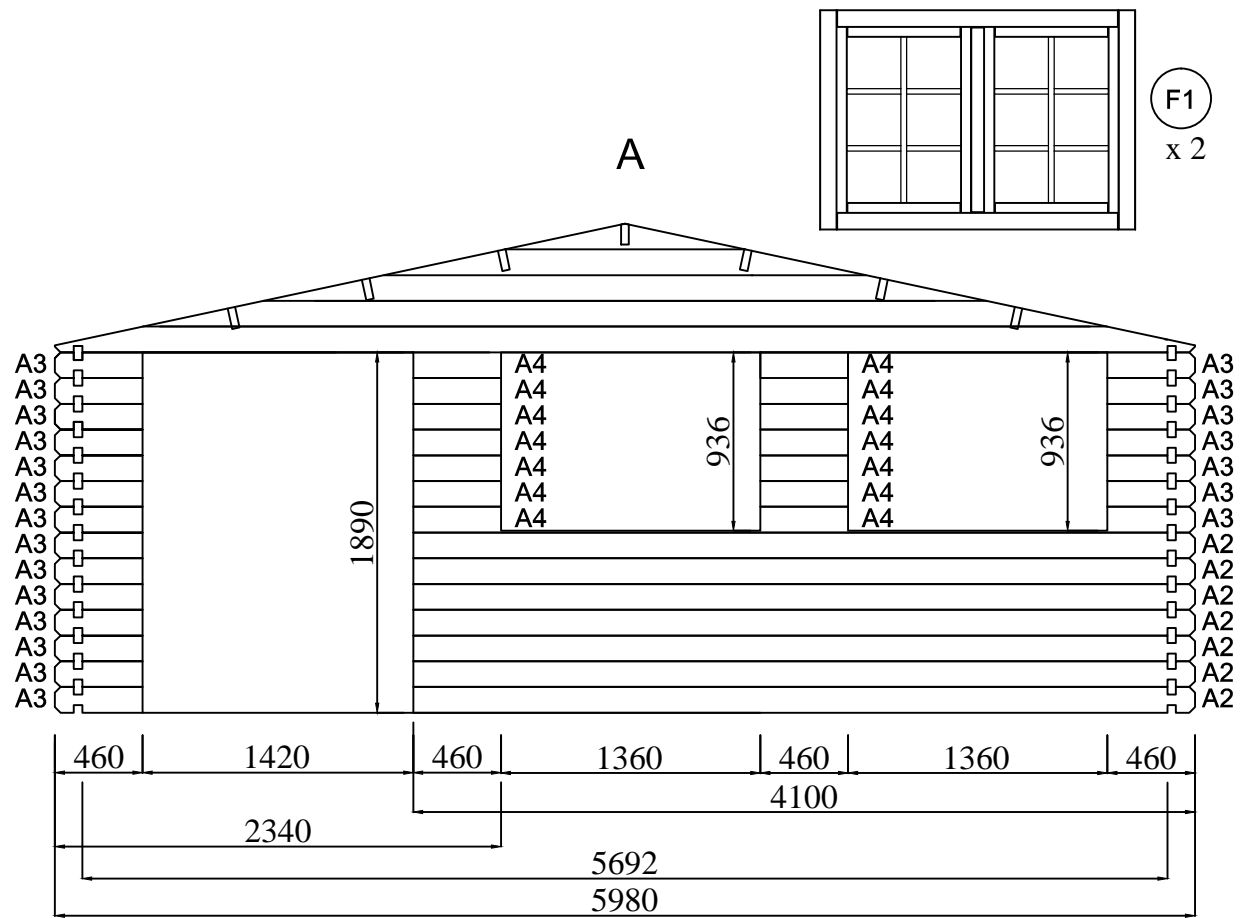
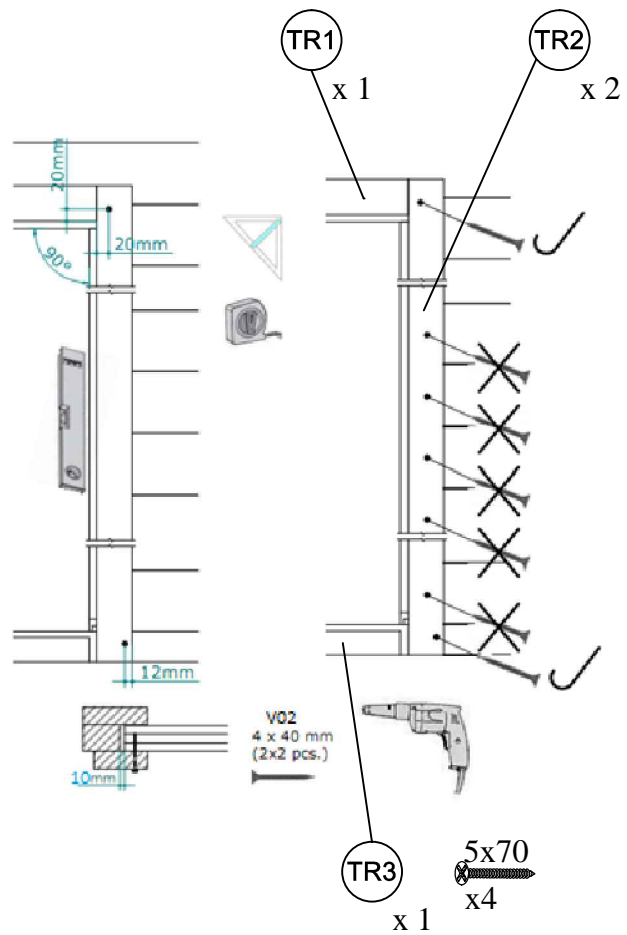

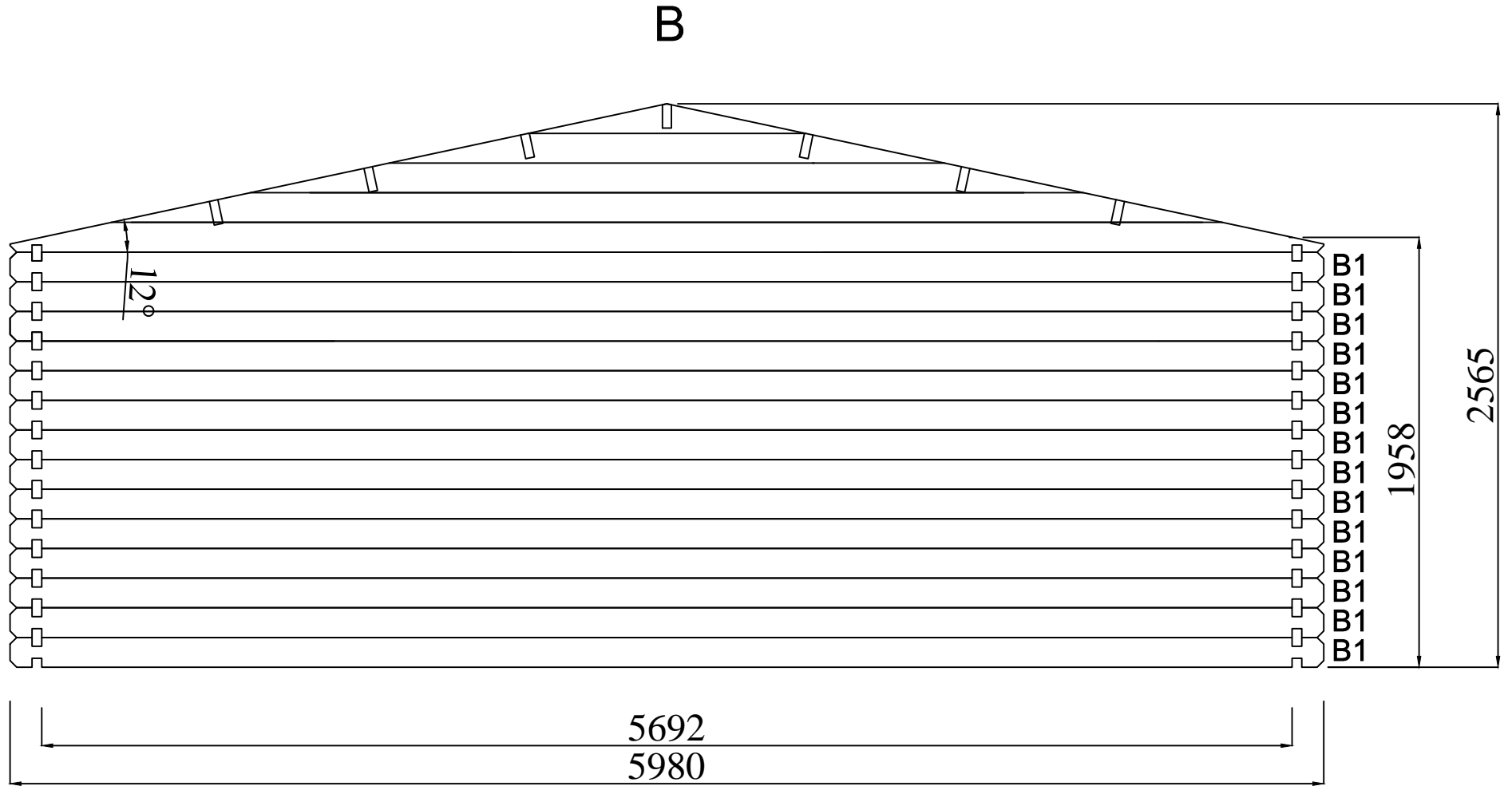

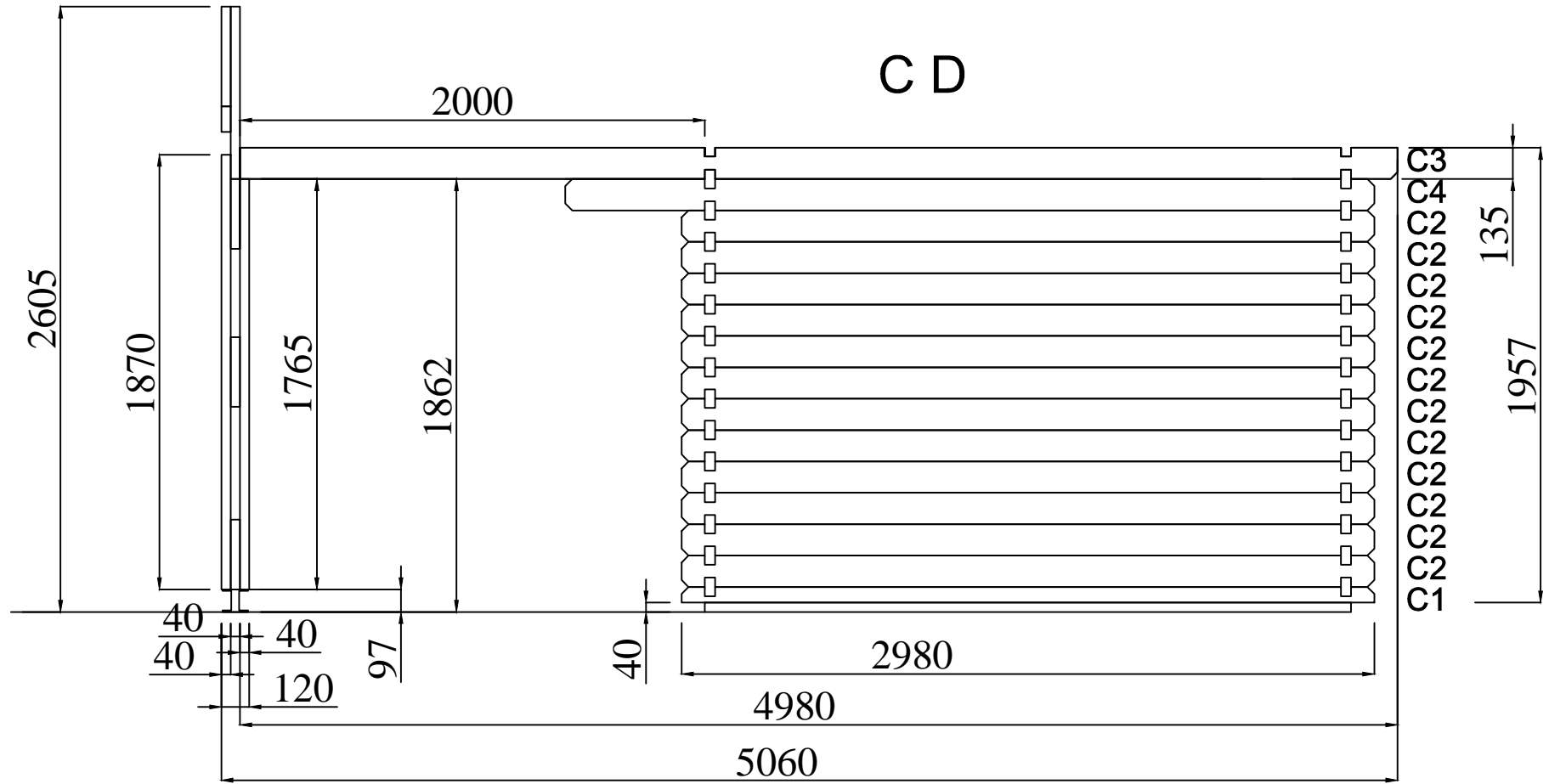



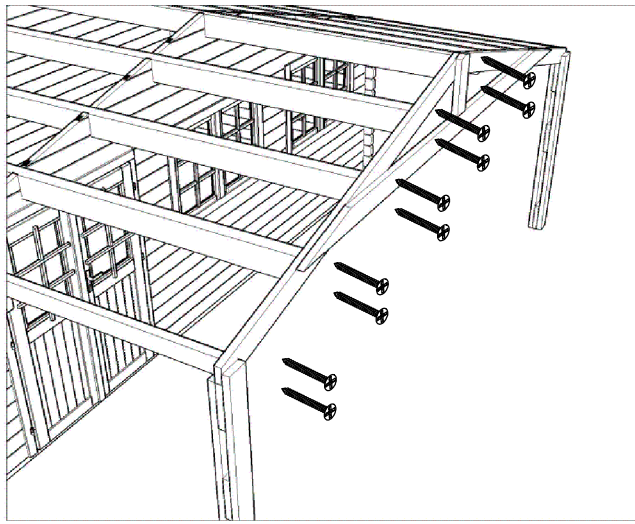

5x120  
x18

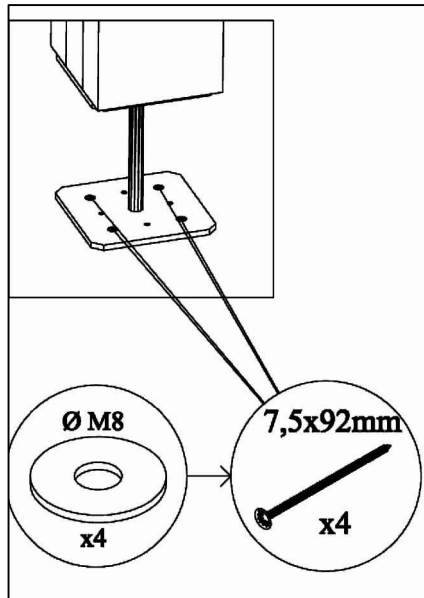
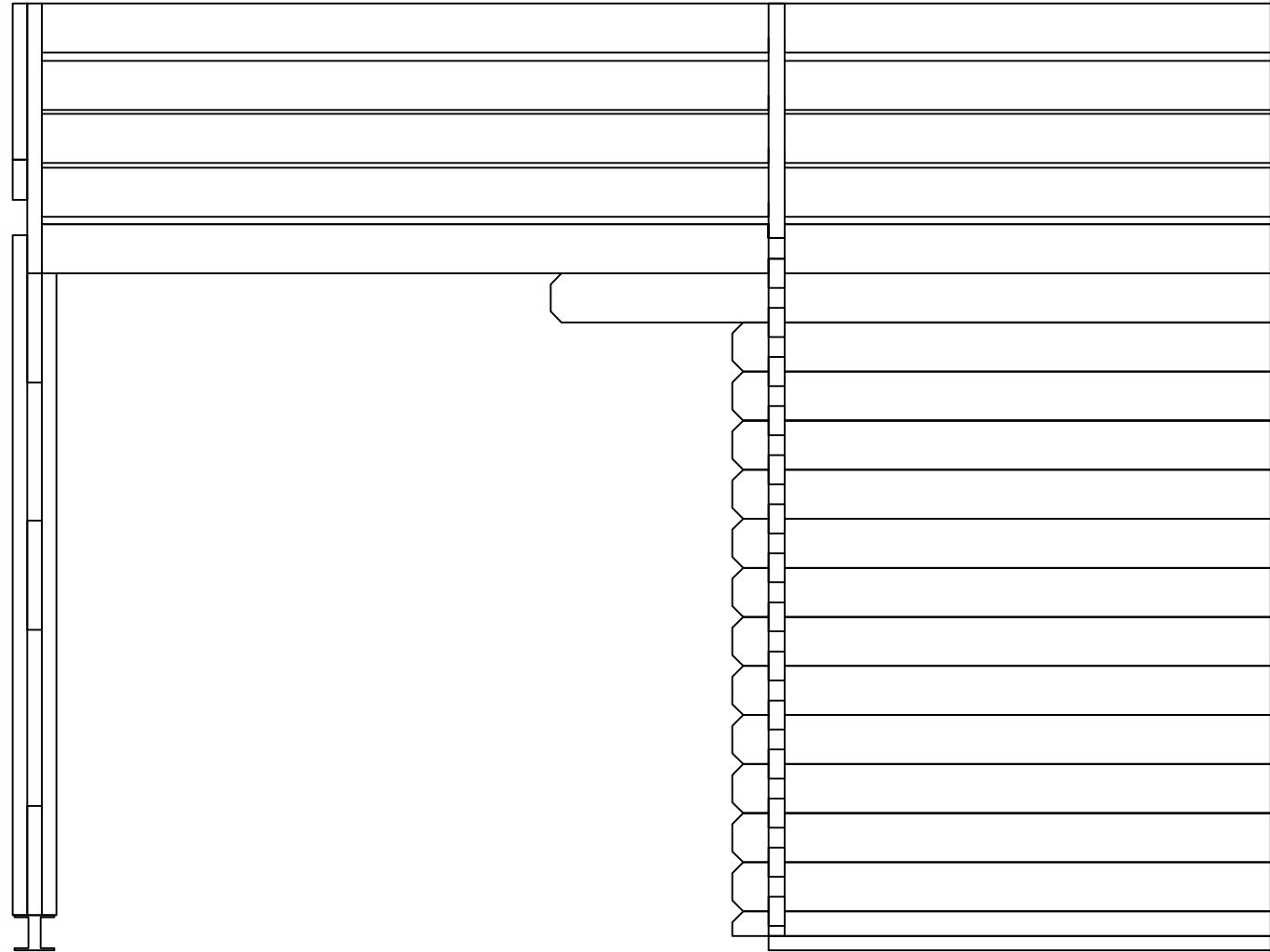

# SAAR 1

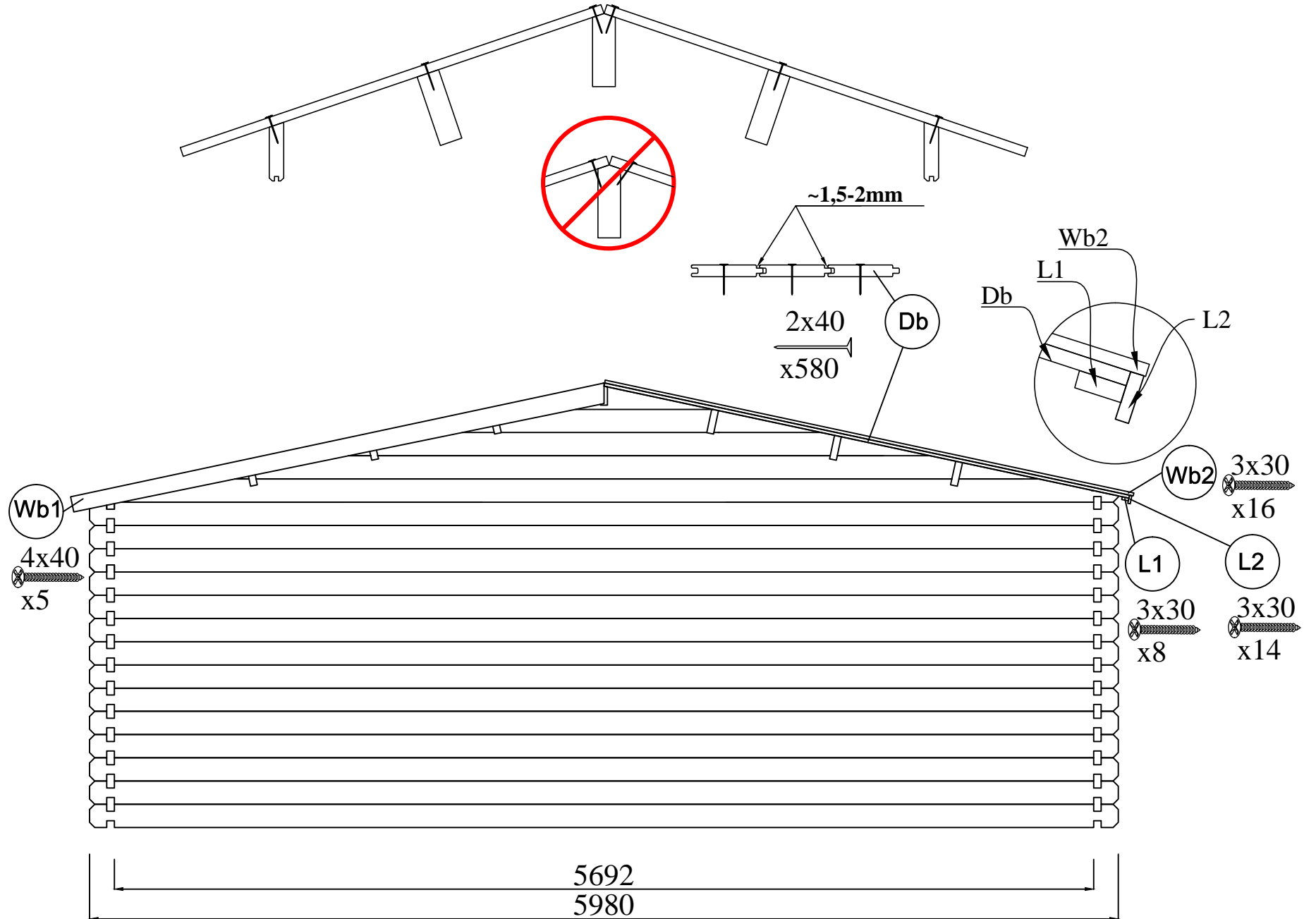

SAAR 1

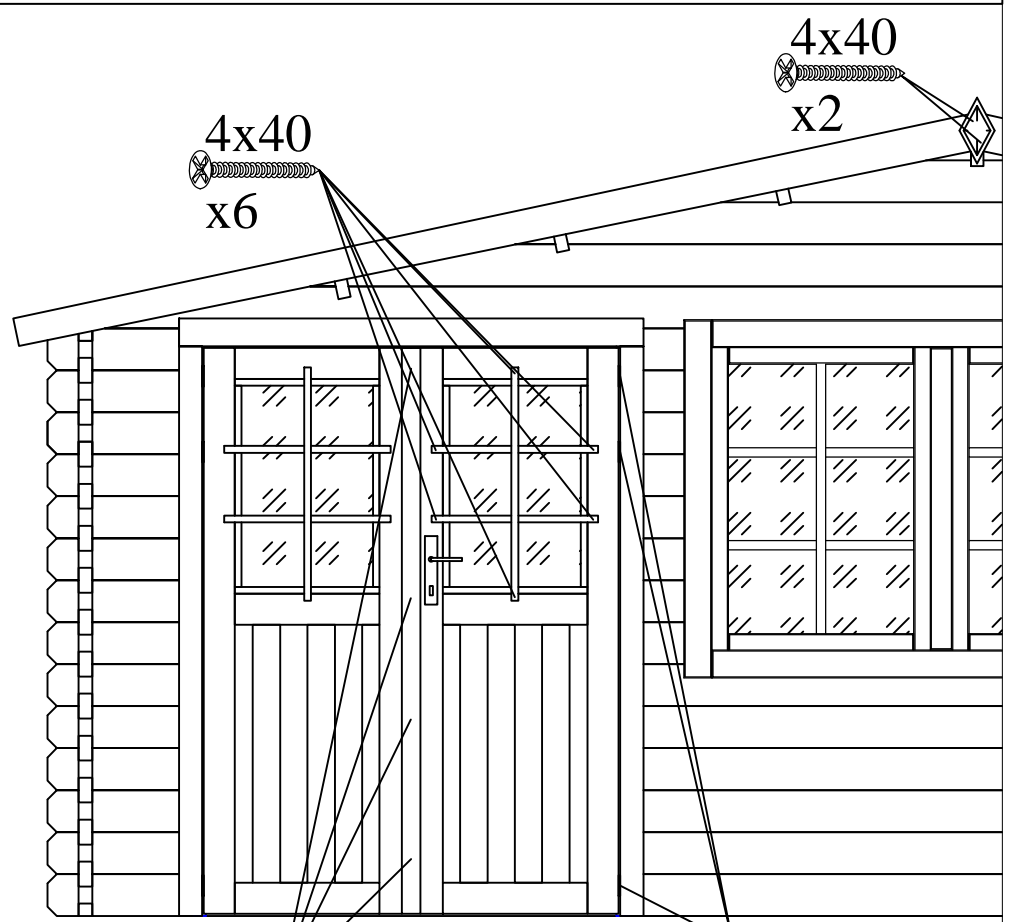
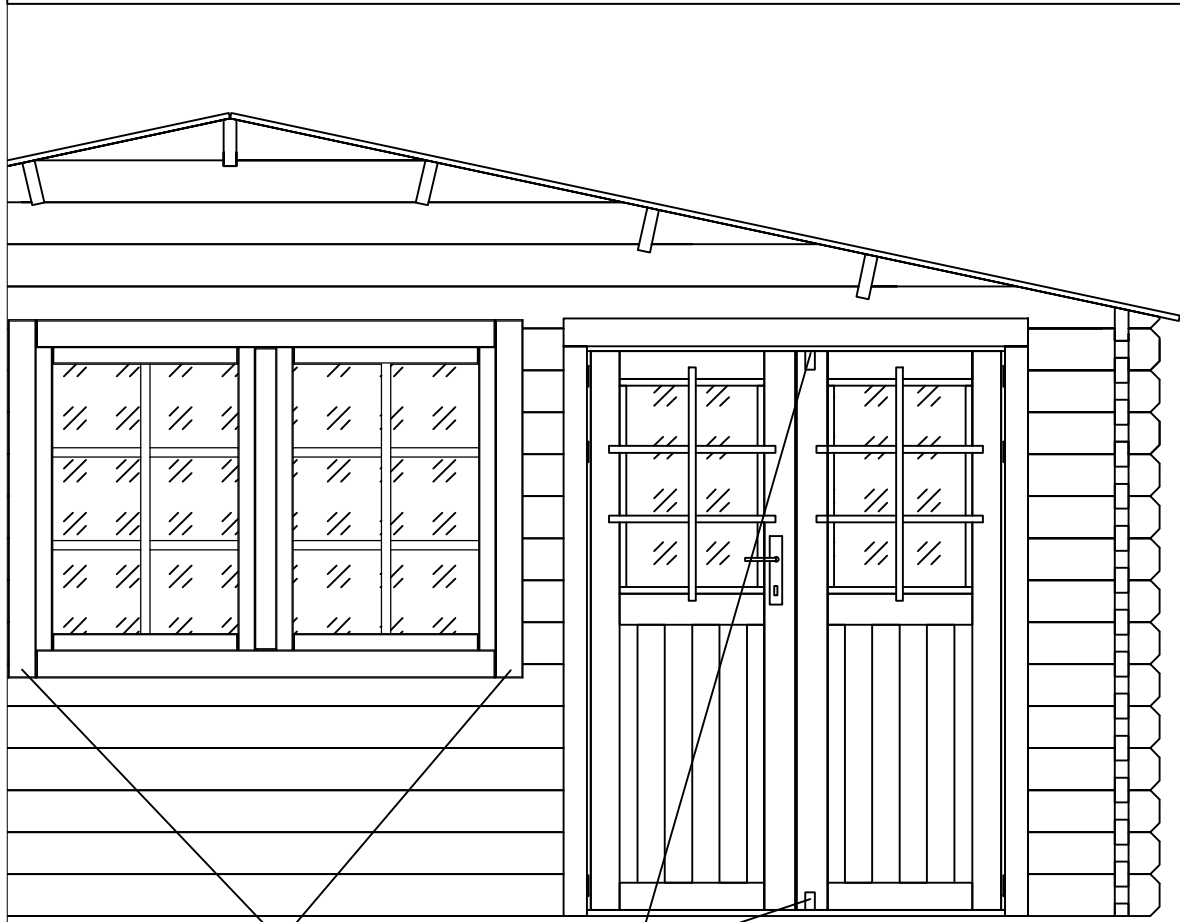

4x40  
x2

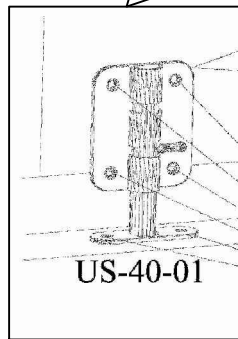

3x20  
x6

4x40  
x6

4x40  
x2

3x30  
x4

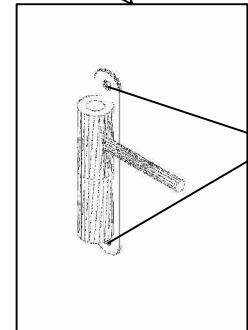

4x40  
x2

# SAAR 1

