

Domeo 3
Art. Nr. 4423819020
1/8

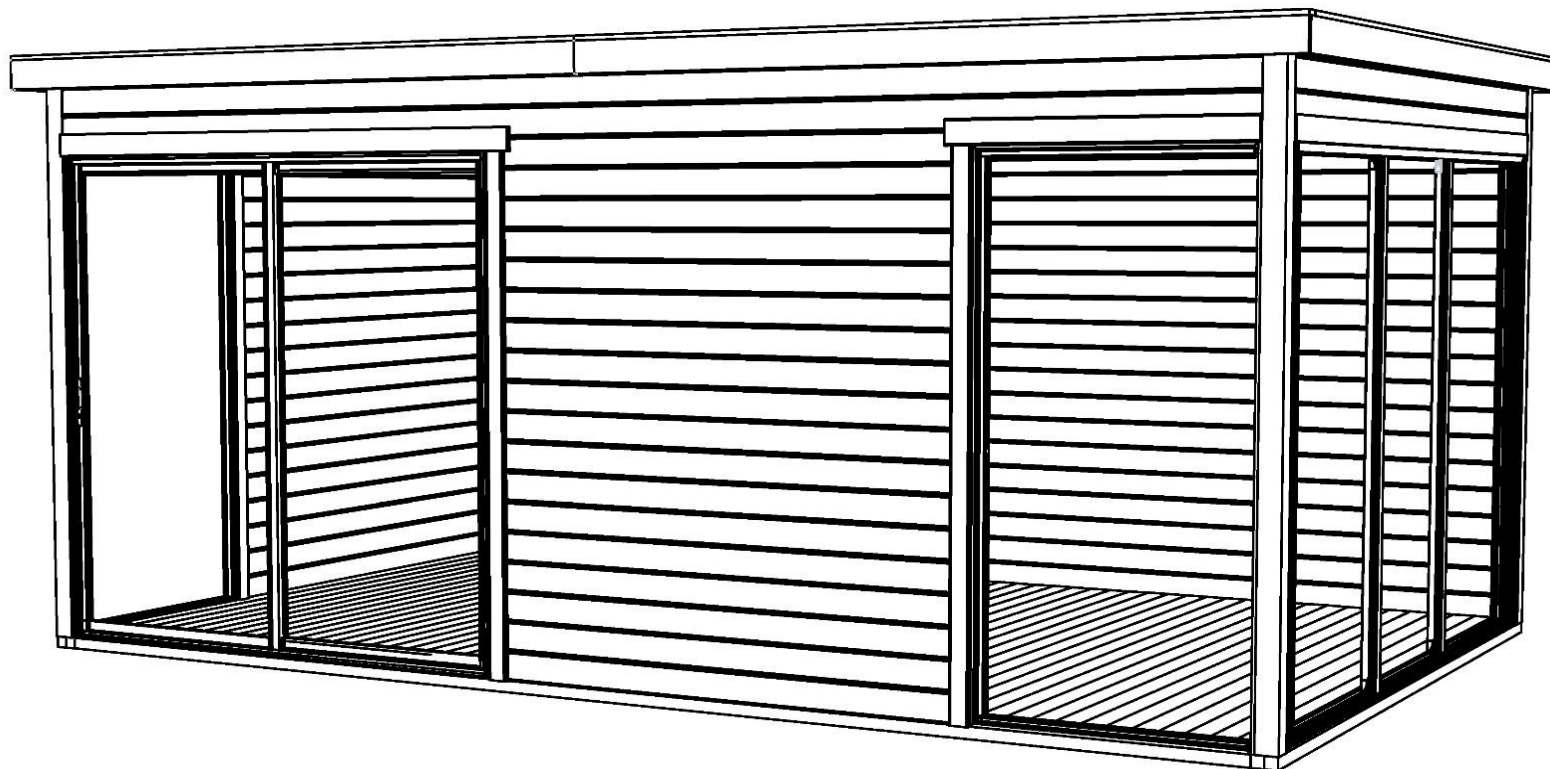

30.07.2018

Art.Nr. 4423819020

Groundplan - Grundplan - Plan de masse - Planimetria - Plattgrond - Põhiplaan

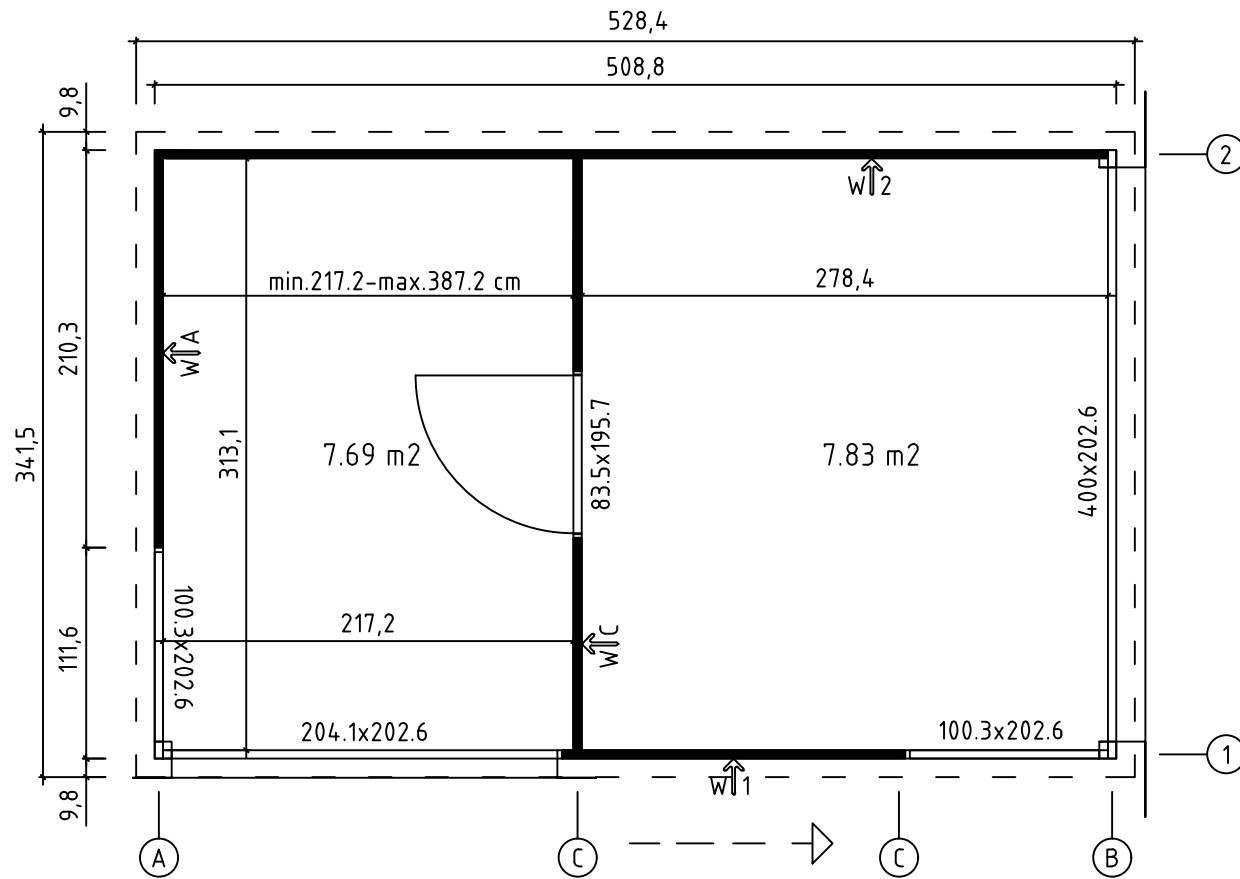

Art.Nr. 4423819020

Foundation - Fundament - Fondation -
Fondamenta -Fundering - Immutatud alusraam

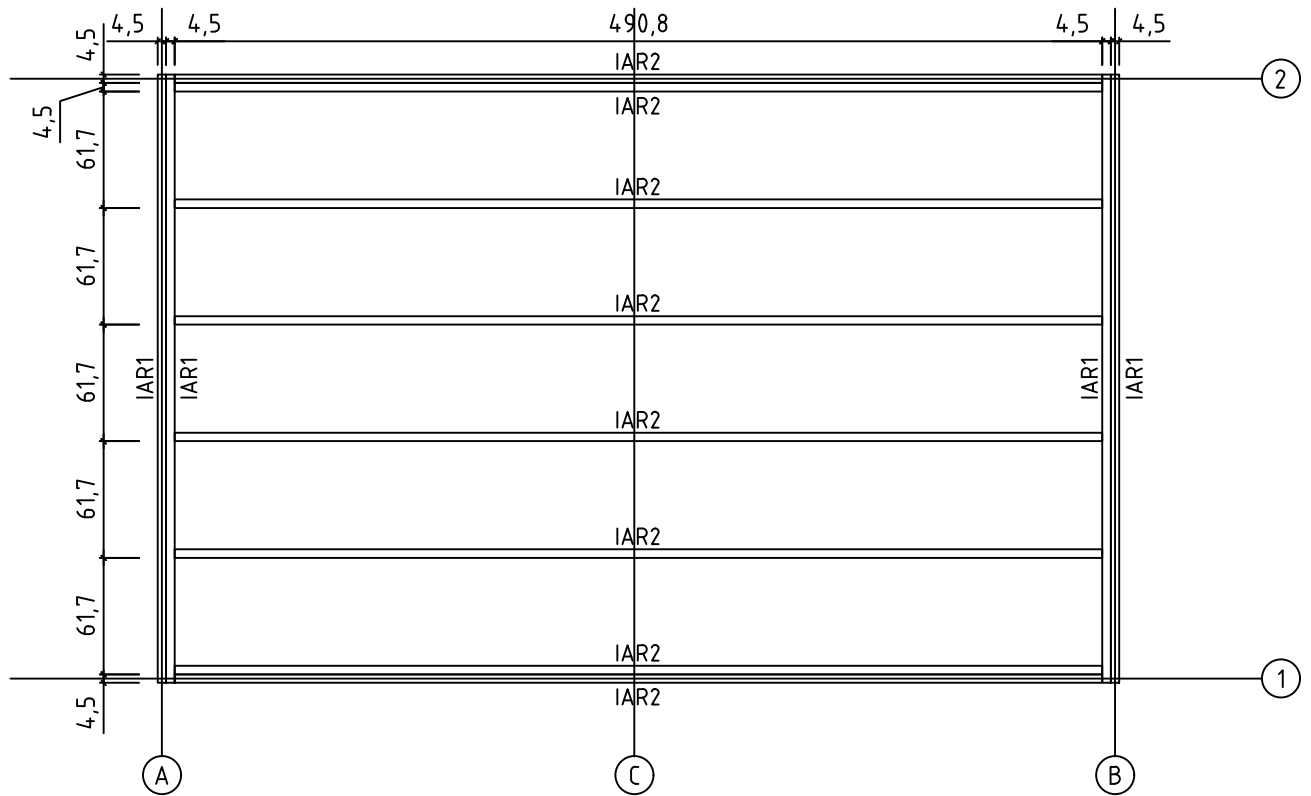



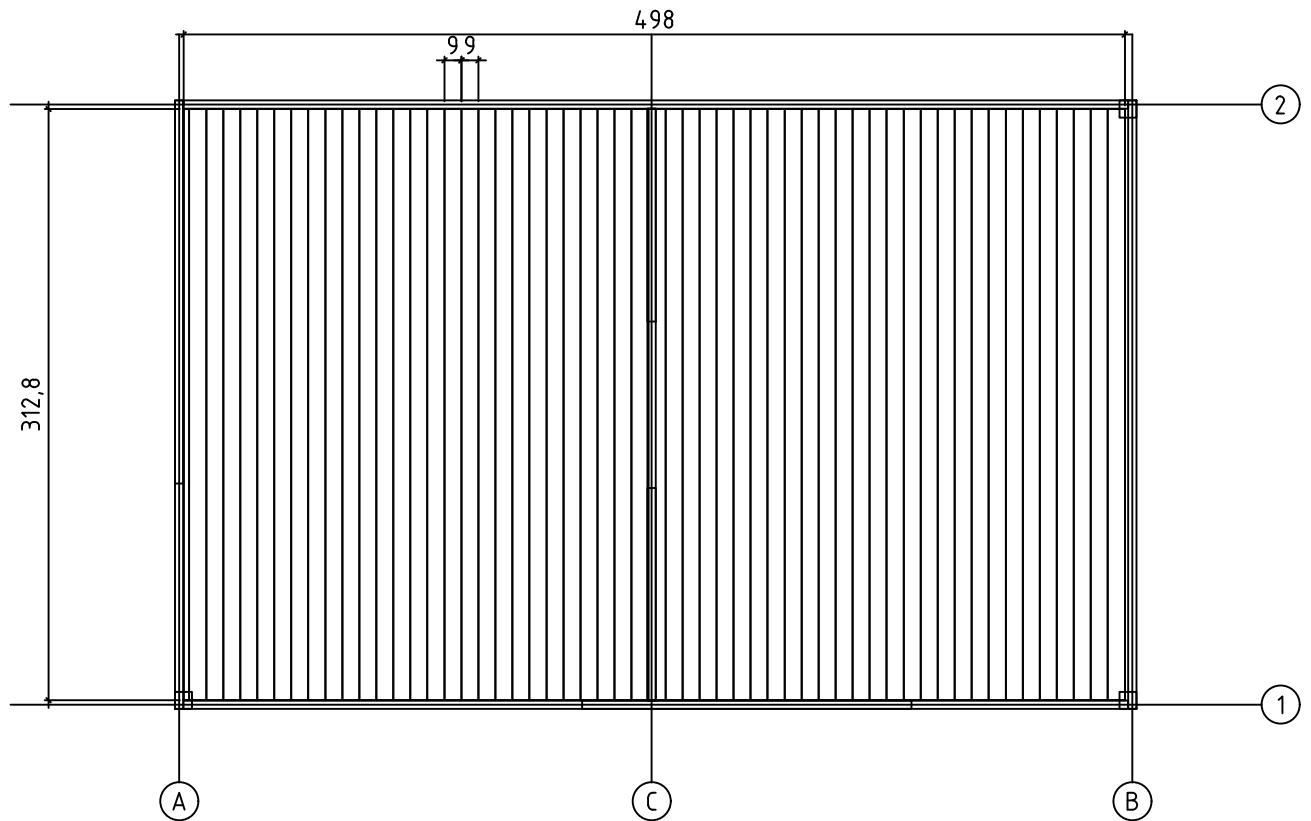

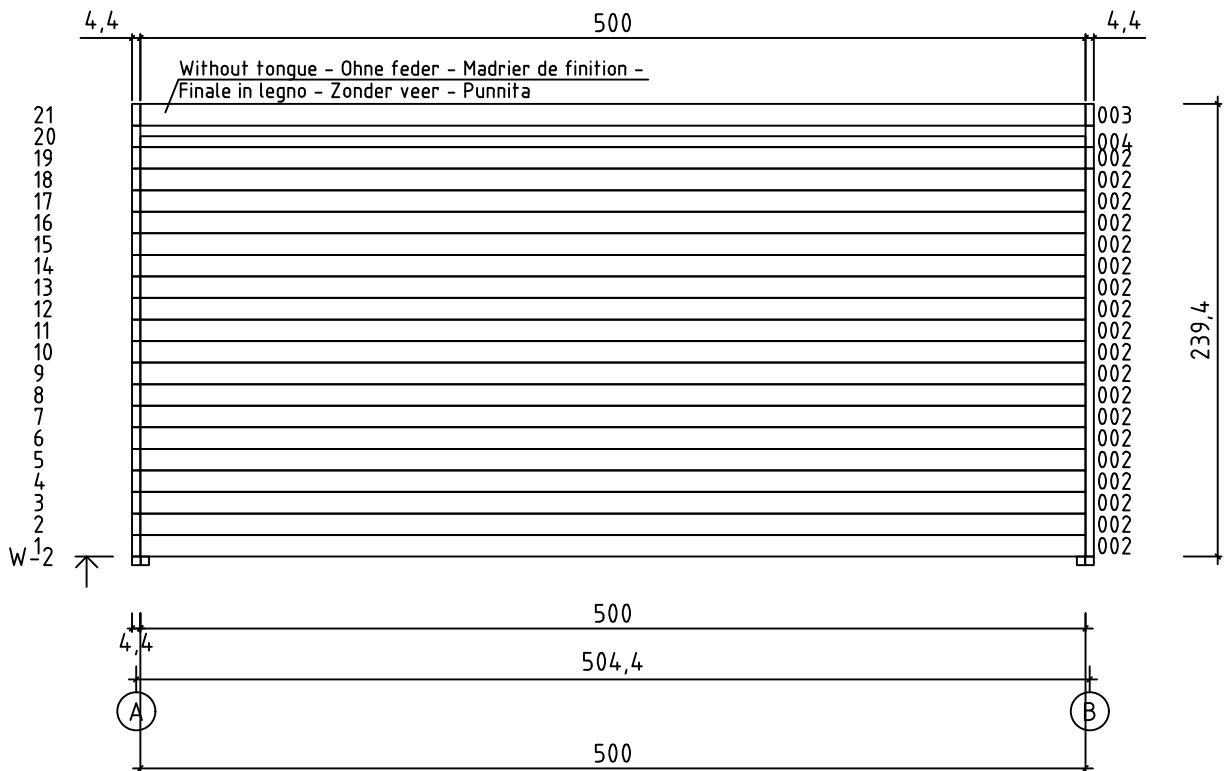
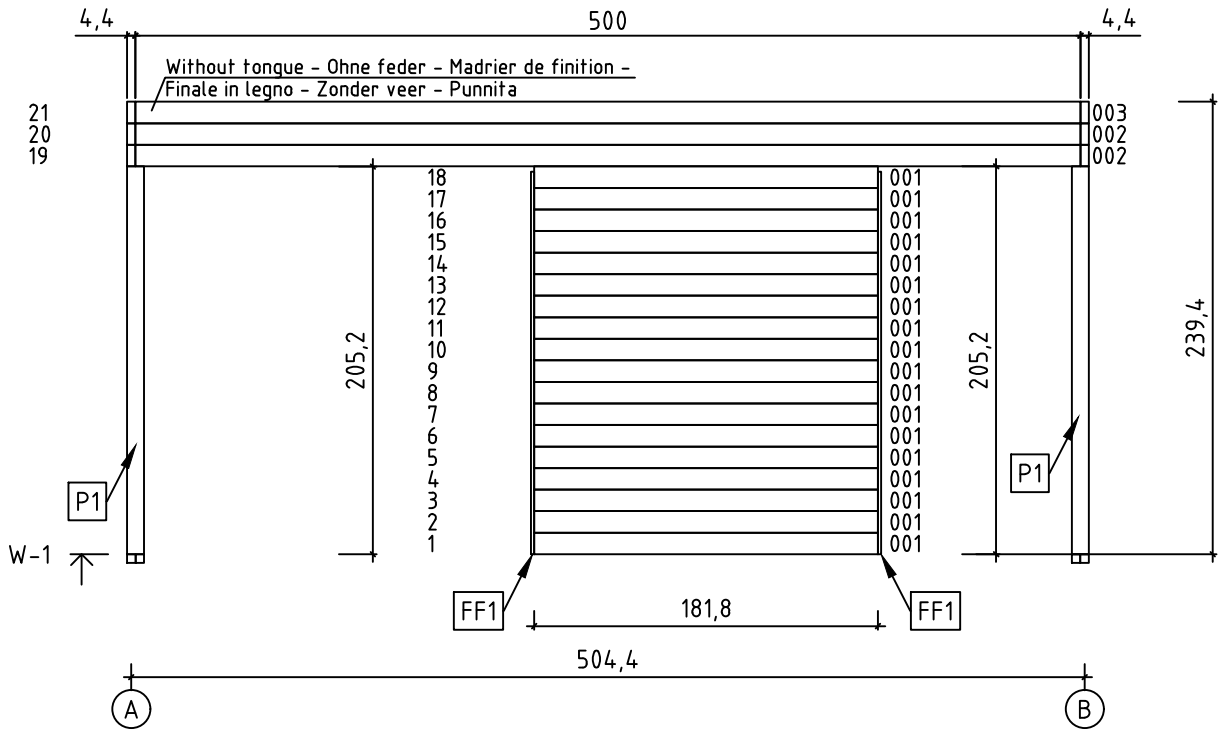

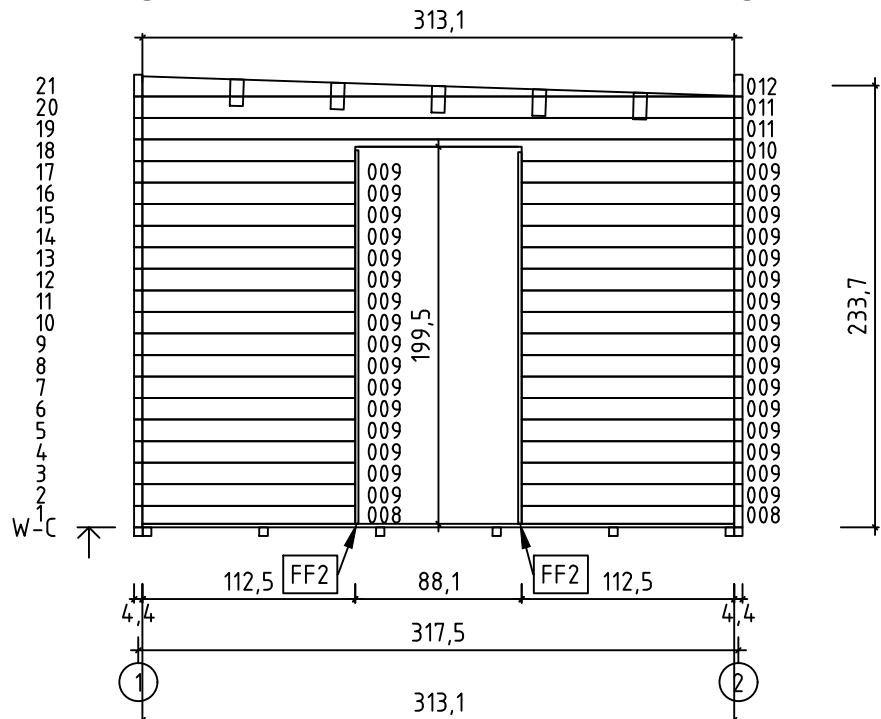
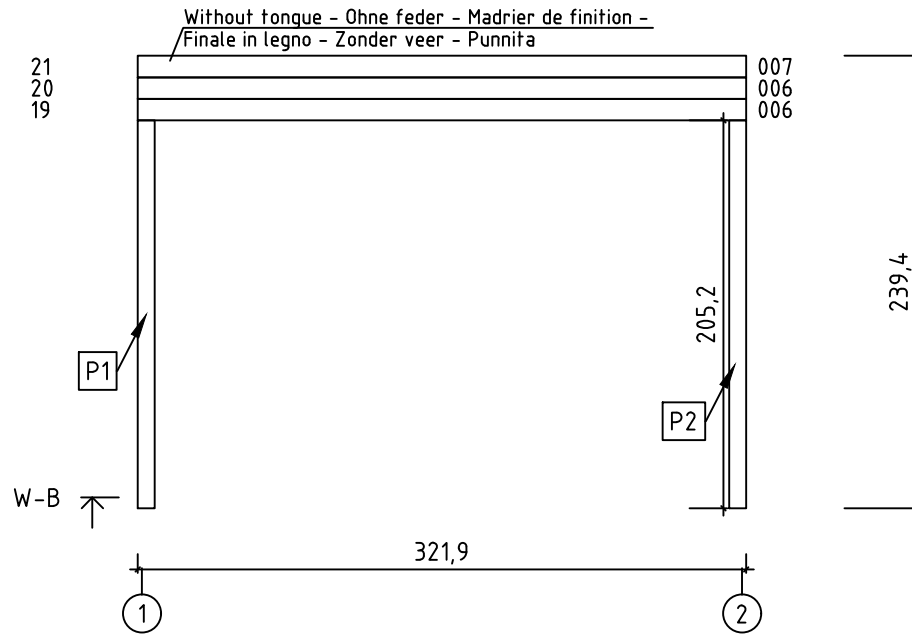
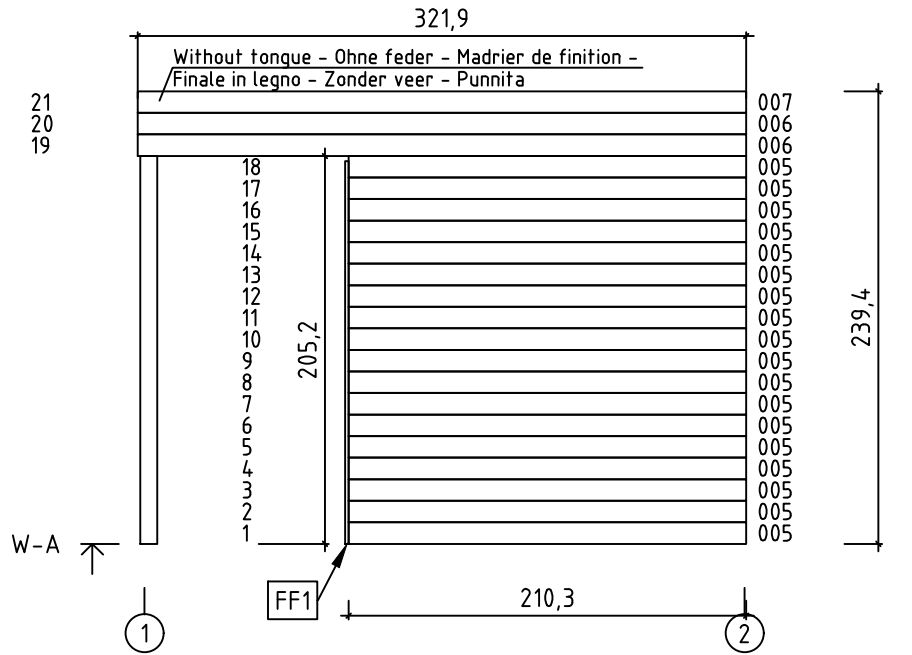

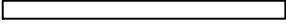
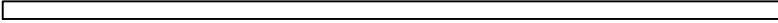
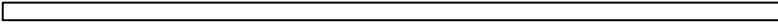
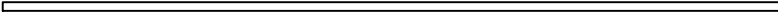
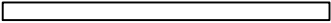
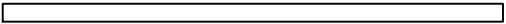
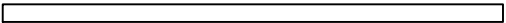
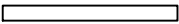
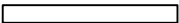
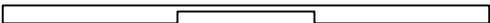
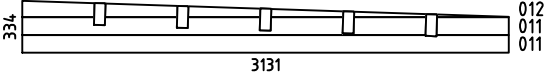

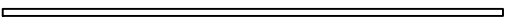
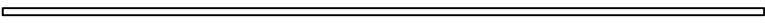
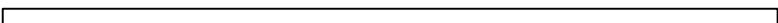









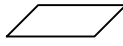



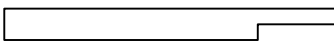
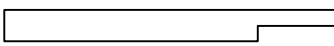
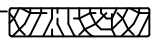
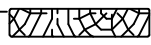





Floor boards - Fussbodenbretter - Plan pose plancher -
Pavimento - Vloerhout - Põrandalaudis







Pos	30.07.2018 Piece list - Stückliste - Liste des pièces - Elementi - Stuklijst - Tükitalbel Art.Nr. 4423819020 6/8	Q	P (mm)	L (mm)
001		18	44x114	1818
002		21	44x114	5000
003		2	44x114	5000
004		1	44x57	5000
005		18	44x114	2103
006		4	44x114	3219
007		2	44x114	3219
008		2	44x96	1125
009		32	44x114	1125
010		1	44x114	3131
WC-1		1		
IAR2	Foundation - Fundament - Fondation - Fondamenta - Fundering - Immutatud alusraam 	8	45x45	4908
IAR1	Foundation - Fundament - Fondation - Fondamenta - Fundering - Immutatud alusraam 	4	45x45	3219
RV1	Lath - Pfetten - Liteau - Piccola asse - Gordingen - Roov 	1	44x44	4900
A-PR1	Roof beam - Dachbalken - Panne de toit - Perlina del tetto - Gordingen / dakbalk - Pärlin 	5	70x140	4985
FB	Floor boards - Fussbodenbretter - Lame de plancher - Pavimento - Vloerhout - Põrandalaud 	56	90x18	3128
DB	Roof boards - Dachbretter - Voliges - Perlina per tetto - Dakhout - Katuselaud 	56	90x18	3250
	Floor fillet - Fussbodenleiste - Corniere de finition du plancher - Finitura per pavimento (battisco pa) - Vloerafwerklijst - Põrandaliist 		18x18	16.22
AL-1	Al. Corner - Alu Eckprofil - Coin en aluminium - Alluminio angolo - Aluminium hoek - Alumiinium nurk 	4	80x80	2330
DL5	Batten - Deckleiste - Profils de finition angles a l'exterieur - Asse - Afdek lijst - Katteliist 	1	15x40	2203
DL4	Batten - Deckleiste - Profils de finition angles a l'exterieur - Asse - Afdek lijst - Katteliist 	1	15x40	2263
DPL1	Roofing felt fillet - Dachpappenleiste - Baguette de fixation du feutre bitumeux - Asse per fissaggio guaina bituminosa - Afdeklijst asfaltpapier - Katusepapiiist 	2	18x58	2642
DPL2	Roofing felt fillet - Dachpappenleiste - Baguette de fixation du feutre bitumeux - Asse per fissaggio guaina bituminosa - Afdeklijst asfaltpapier - Katusepapiiist 	2	18x58	3357

Pos	30.07.2018 Piece list - Stückliste - Liste des pièces - Elementi - Stuklijst - Tükitalabel Art.Nr. 4423819020 7/8	Q	P (mm)	L (mm)
TP1	Diagonal support batten - Hilfsleiste - Tasseau - Listelli per rinforzare - timmerhout - Tugilaud 	4	18x90	350
TP2	Diagonal support batten - Hilfsleiste - Tasseau - Listelli per rinforzare - timmerhout - Tugilaud 	6	18x90	1200
EP2	Post - Pfosten - Poteau - Piede registrabile - Stijl - Post 	2	44x44	2203
EP1	Post - Pfosten - Poteau - Piede registrabile - Stijl - Post 	1	44x44	2263
P2	Post - Pfosten - Poteau - Piede registrabile - Stijl - Post 	1	90x90	2223
P1	Post - Pfosten - Poteau - Piede registrabile - Stijl - Post 	2	90x90	2327
GL2	Fascia board - Traufbrett - Bandeau de toit - Finitura lati tetto - Gevellijst - Räästalaud 	4	18x120	2642
GL1	Fascia board - Traufbrett - Bandeau de toit - Finitura lati tetto - Gevellijst - Räästalaud 	2	18x120	3379
DRV-1	Roof edge reinforcement - Dachrandverstärkung - Corniere de renfort de bord de toit - Rinforzo x tetto - Dakrand versterking - Räästatugevdus 	4	80x44	2544
DRV-2	Roof edge reinforcement - Dachrandverstärkung - Corniere de renfort de bord de toit - Rinforzo x tetto - Dakrand versterking - Räästatugevdus 	2	80x44	3379
FF2	Fixing fillet - Fixierungsleiste - Profil de fixation - Massello di fissaggio - Bevestiging lijstwerk - Tenderliist 	2	18x44	1967
FF1	Fixing fillet - Fixierungsleiste - Profil de fixation - Massello di fissaggio - Bevestiging lijstwerk - Tenderliist 	3	18x44	2024
HS8	Screw for corner fillet - Schraube zur befestigung deckleiste - Vis pour profils de finition angles a l'exterieur - Viti per massellino d'angolo - Schroef voor afdeklijst (hoek) - Kruvi nurgaliistudele 	42	3.5x35	
HS29	Screw for Al. Corner - Schraube für befestigung des eckprofils - Vis pour coin en aluminium - Vite per fissare angolo di alluminio - Schroef voor bevestiging aluhoek - Kruvi Al.nurga kinnitamiseks 	40	4.2x25	
HS14	Screw for post - Schrauben für pfosten - Vis de fixation des poteaux - Viti per inviare - Schroef voor stijlen - Kruvi postile 	6	4.5x80	
HS14	Screw for wall details - Schraube für wand details - Vis pour mur details - Viti per elementi della porta - Schroef voor wand details - Kruvi seinte montaažiks 	210	4.5x80	
HS12	Screw for diagonal support batten - Schraube für dachlatte - Vis de tasseau - Vite per listelli per rinforzare - Schroef voor timmerhout - Kruvi tugilauale 	18	4x40	
HS12	Screw for diagonal support batten - Schraube für dachlatte - Vis de tasseau - Vite per listelli per rinforzare - Schroef voor timmerhout - Kruvi tugilauale 	16	4x40	
HS12	Screw for fascia boards - Schrauben für traufbretter - Vis pour fixation bandeau de toit - Viti x striscia del tetto - Schroef voor gevellijst - Kruvi räästalauale 	36	4x40	
HS12	Screw for beam holder - Schrauben für balkenhalter - Vis de fixation support "u" galvanisé - Vite per trave di sostegno - Schroef voor bevestiging balkhouder (gordingschoen) - Kruvi talakingale 	120	4x40	
HS12	Screw for fixing fillet of door and window - Schrauben für fixierungsleiste - Vis pour profil vertical de fixation pour ouvertures des fenetres et portes - Viti per massello di fissaggio - Schroeven voor bevestiging van deur en raam lijsten - Kruvi tenderliistudele 	90	4x40	
HS18	Screw for roof beams - Schrauben für dachbalken - Vis pour fixation pannes de toit - Viti per perline del tetto - Schroef voor gordingen / dakbalken - Kruvi pärlinitele 	5	5x120	
HS16	Screw for foundation - Schrauben zur befestigung fundament - Vis de fixations des poutrelles de fondations - Viti x fondamenta - Schroef voor fundering - Kruvi alusraamile 	16	5x90	

