



Kiosk

008.001.001.001



blue rabbit

© 2014

Blue Rabbit 2.0 - Hemelrijken 8 - B-2890 St-Amands - Belgium.
Copyrighted material - Do not reproduce under penalty of law.



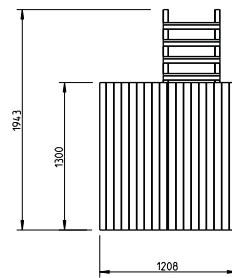
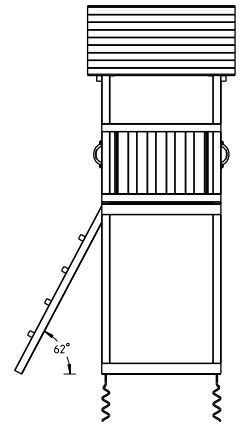
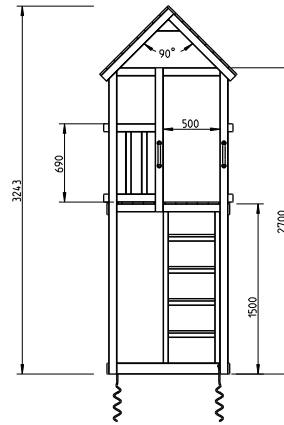

①

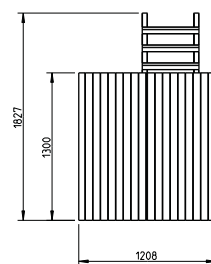
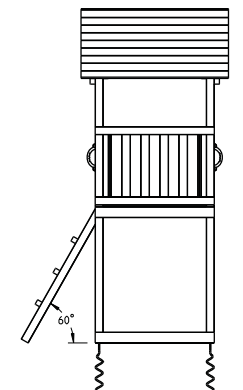
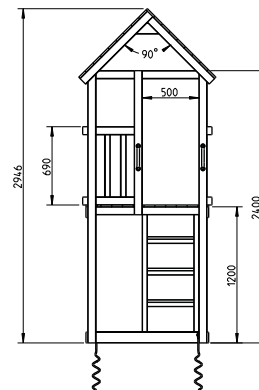

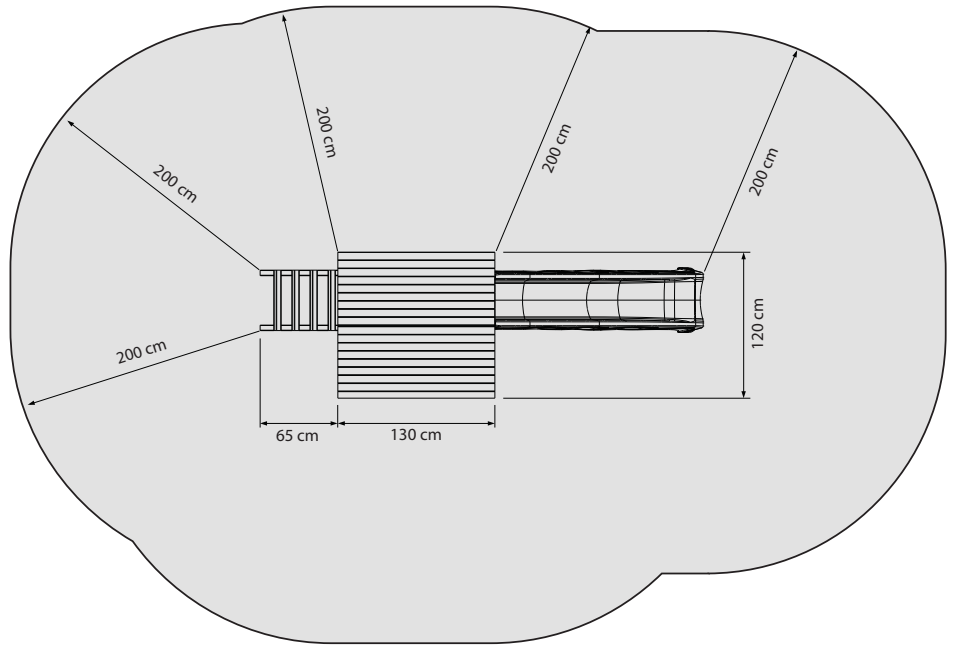
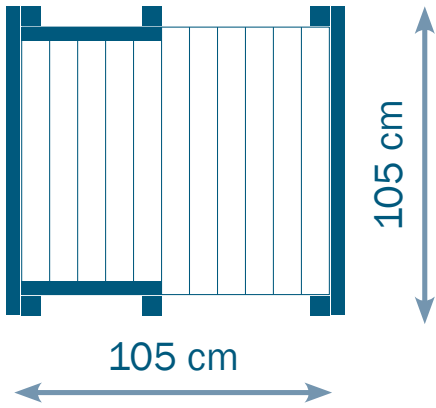
②

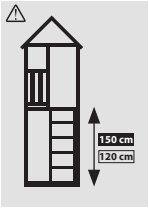
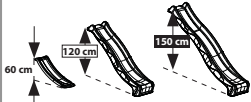

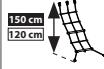
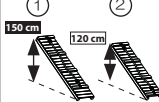
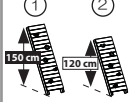
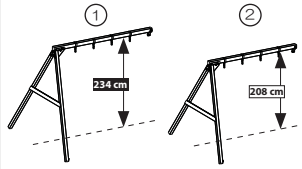

 Kiosk 008.001.001.001	 @platform 008.003.006.001		 @bridge 008.003.004.001		 @net 008.003.003.001		 @ramp 008.003.002.001		 @wall 008.003.001.001		 @swing 008.003.005.001		
	150 cm	120 cm	150 cm	120 cm	150 cm	120 cm	150 cm	120 cm	150 cm	120 cm	234 cm	208 cm	
 I	X	X	(A) (B)	← I IV →	← II III →	(A) (B)	(A) (B)	(A) (B)	X	(A) (B)	X	← I II III IV →	X
 II	X	(A) (B)	X	← I IV →	← II III →	(A) (B)	(A) (B)	X	(A) (B)	X	(A) (B)	X	← I II III IV →

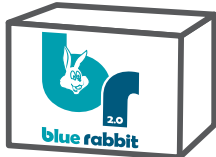

53 x 28 x 11 cm 5,15 kg

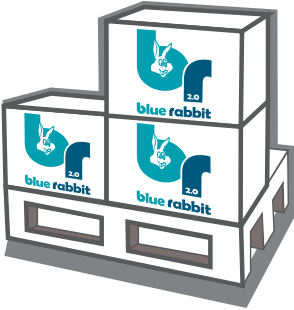

78 120 x 80 x 158 cm 427 kg



30 mm - 45 mm - 80 mm



50 mm - 80 mm

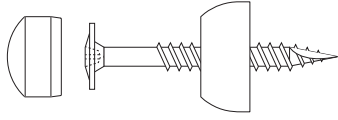

80 mm

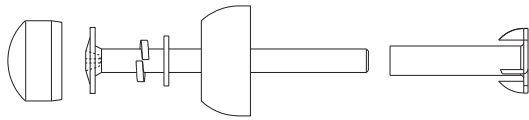

90 / 110 mm

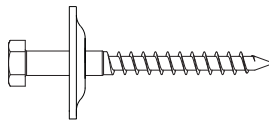

70 mm

4x



2x



TX20



TX40



3



5



10

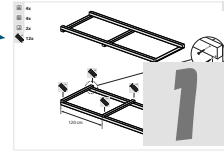

1

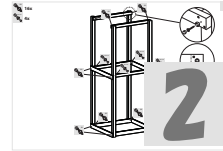

2

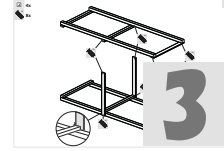

















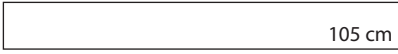

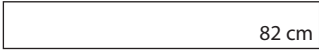



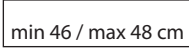

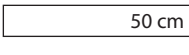
3



4

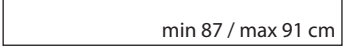

(no wood included)

- 4x** **A** min 68 mm | max 90 mm   240 cm | 270 cm
min 68 mm | max 90 mm
- 2x** **B** min 68 mm | max 90 mm   127 cm
min 68 mm | max 90 mm
- 2x** **C** min 68 mm | max 90 mm   134 cm | 166 cm
min 32 mm | max 50 mm
- 9x** **D** min 68 mm | max 90 mm   105 cm
min 32 mm | max 50 mm
- 2x** **E** min 68 mm | max 90 mm   82 cm
min 32 mm | max 50 mm
- 2x** **F** min 68 mm | max 90 mm   min 73 / max 75 cm
min 32 mm | max 50 mm
- 4x** **G** min 68 mm | max 90 mm   min 46 / max 48 cm
min 32 mm | max 50 mm
- 3x 4x** **H** min 44 mm | max 45 mm   50 cm
min 44 mm | max 45 mm
- 12x*/18x**** **I** ** min 95 mm | * max 145 mm   130 cm
min 15 mm | max 22 mm
- 6x** **J** ** min 95 mm | * max 145 mm   105 cm
min 15 mm | max 22 mm
- 8x*/12x**** **K** ** min 95 mm | * max 145 mm   min 87 / max 91 cm
min 15 mm | max 22 mm
- 12x*/16x**** **L** ** min 95 mm | * max 145 mm   69 cm
min 15 mm | max 22 mm
- 2x** **M** min 95 mm | max 145 mm   40 cm
min 15 mm | max 22 mm

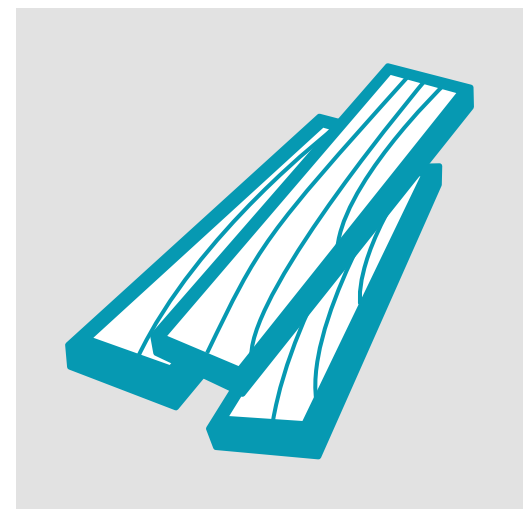
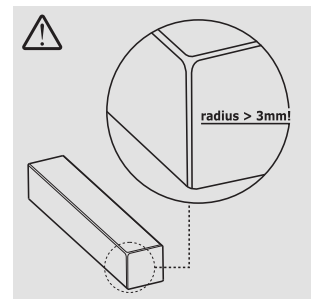
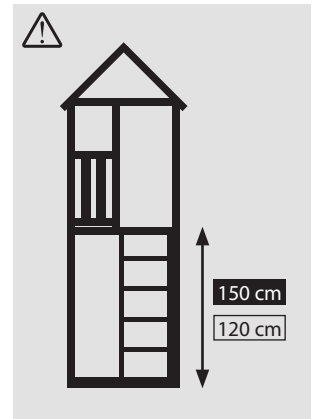



Blue Rabbit 2.0®
Hemelrijken 8
B-2890 Sint-Amands
BELGIUM

info@bluerabbit.be

www.bluerabbit.be