

*Sri Lanka*  
*Art. Nr. 443802*  
*1/10*

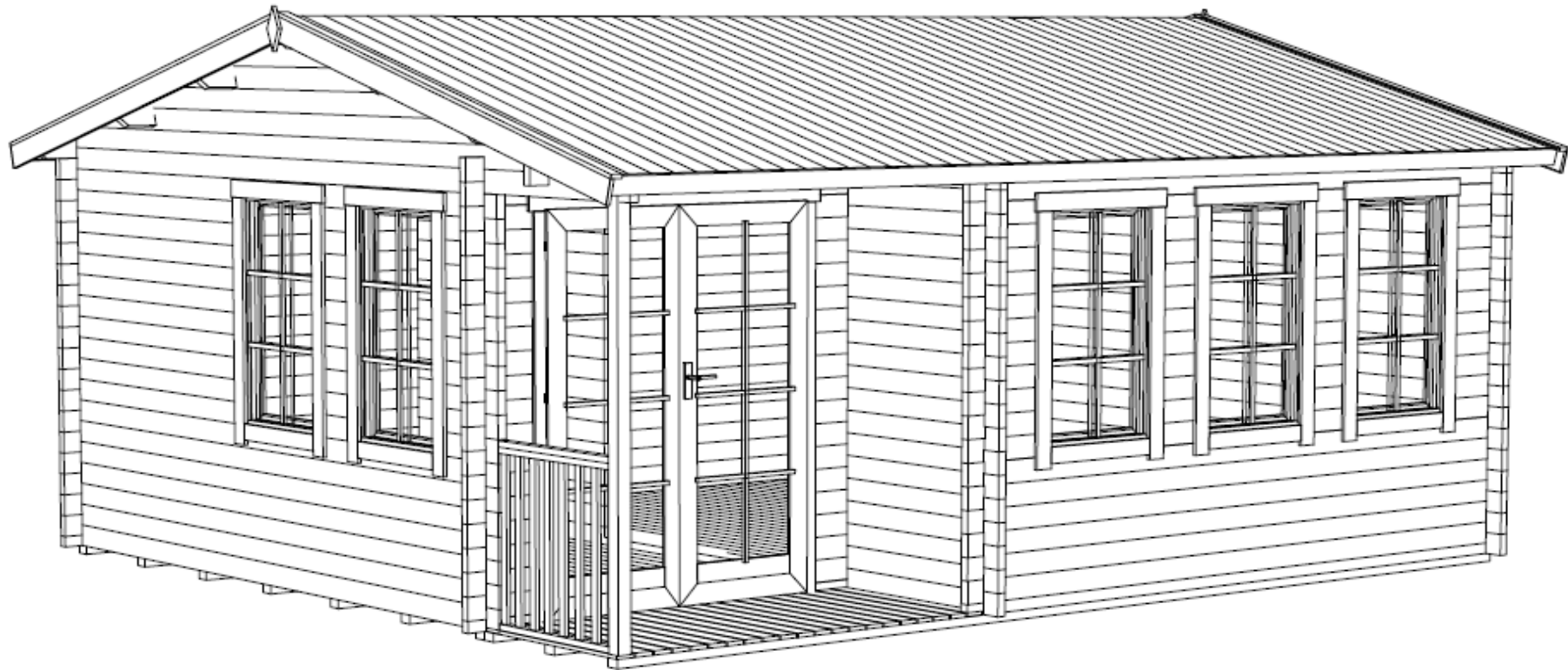

GROUNDPLAN - GRUNDPLAN - PLAN DE MASSE

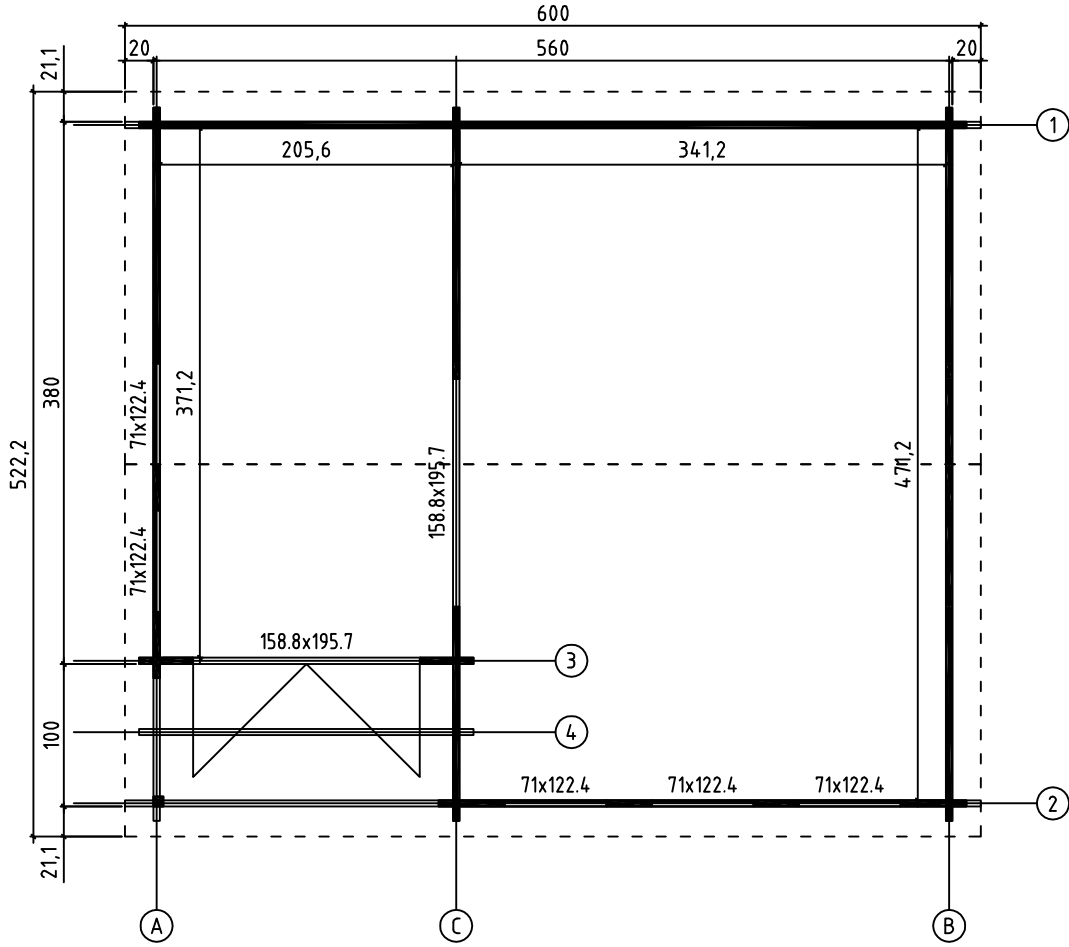

FOUNDATION - FUNDAMENT - FONDATION

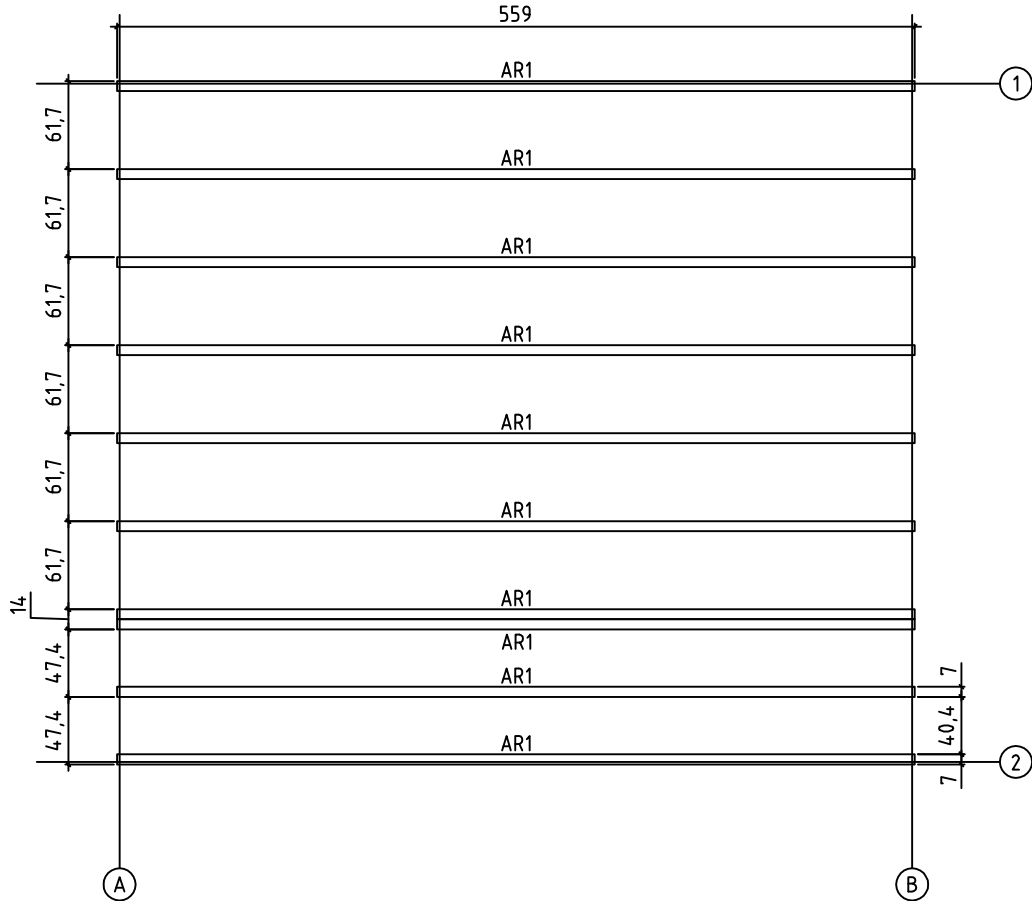

FLOOR BOARDS - FUSSBODENBRETTER - PLAN POSE PLANCHER  
TERRACE BOARDS - TERRASSENBRETTER - PLANCHER DE TERRASSE

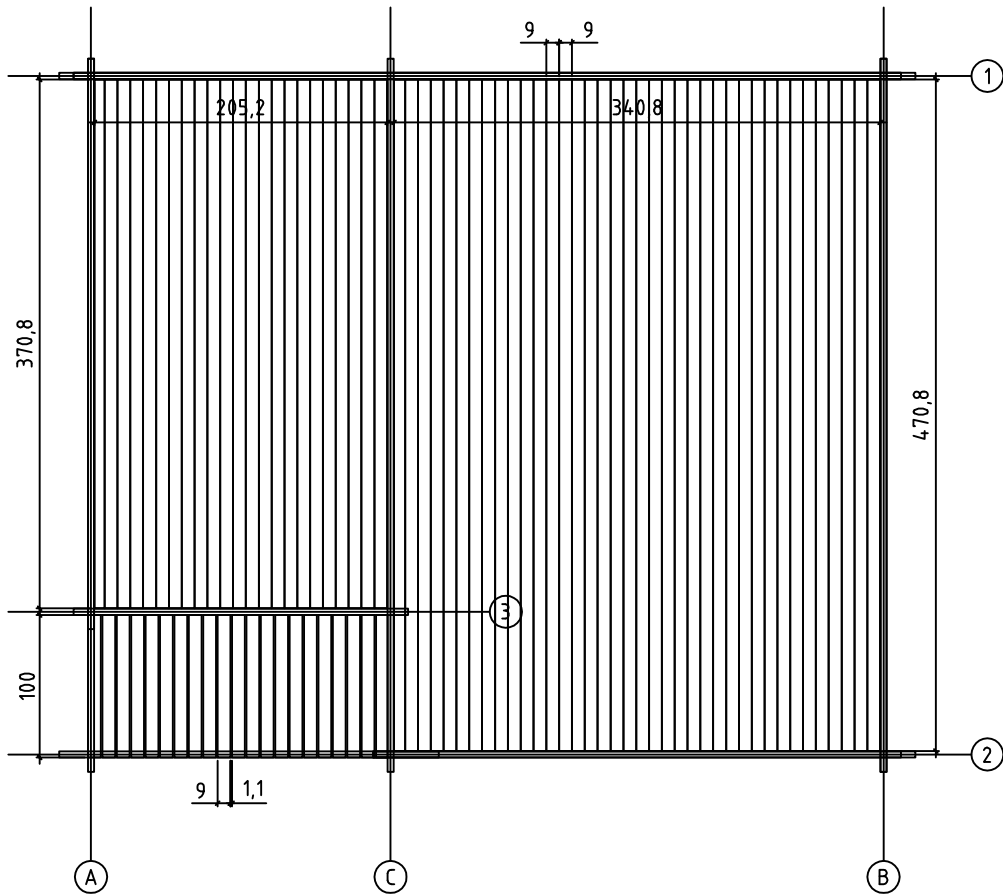

CEILING BOARDS - DECKENBRETT - VOLIGES SOUS PLAFOND

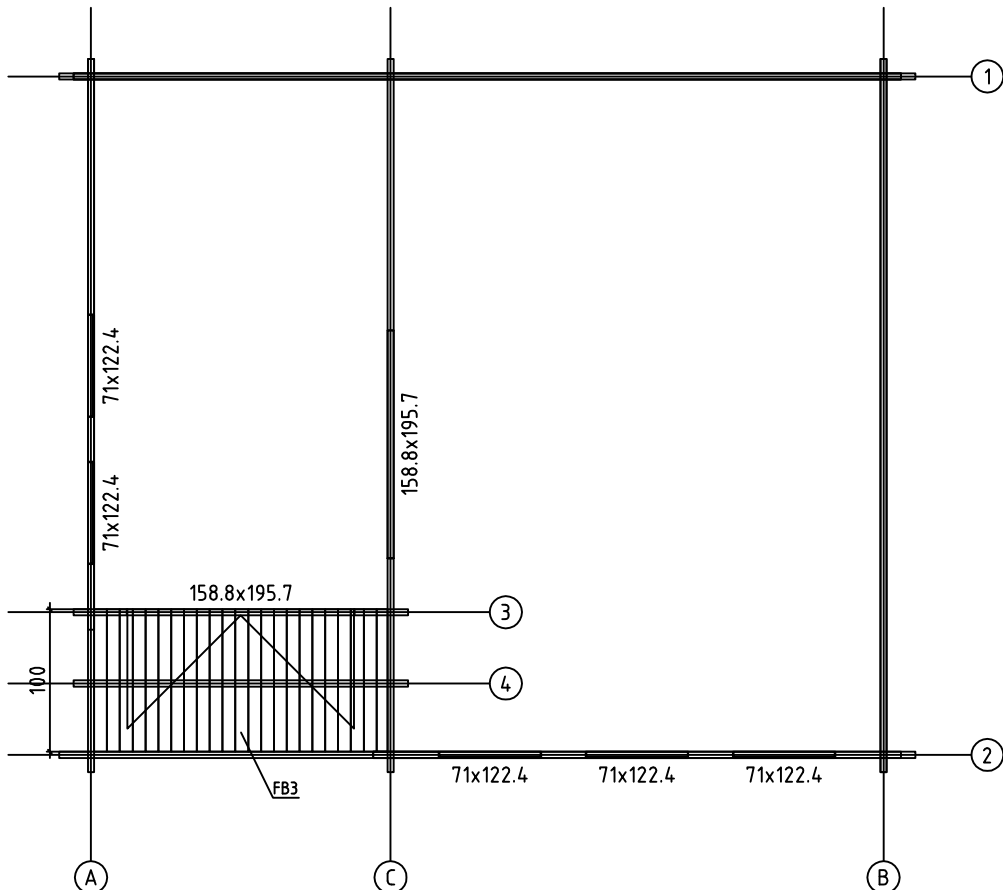

Art.Nr. 443802

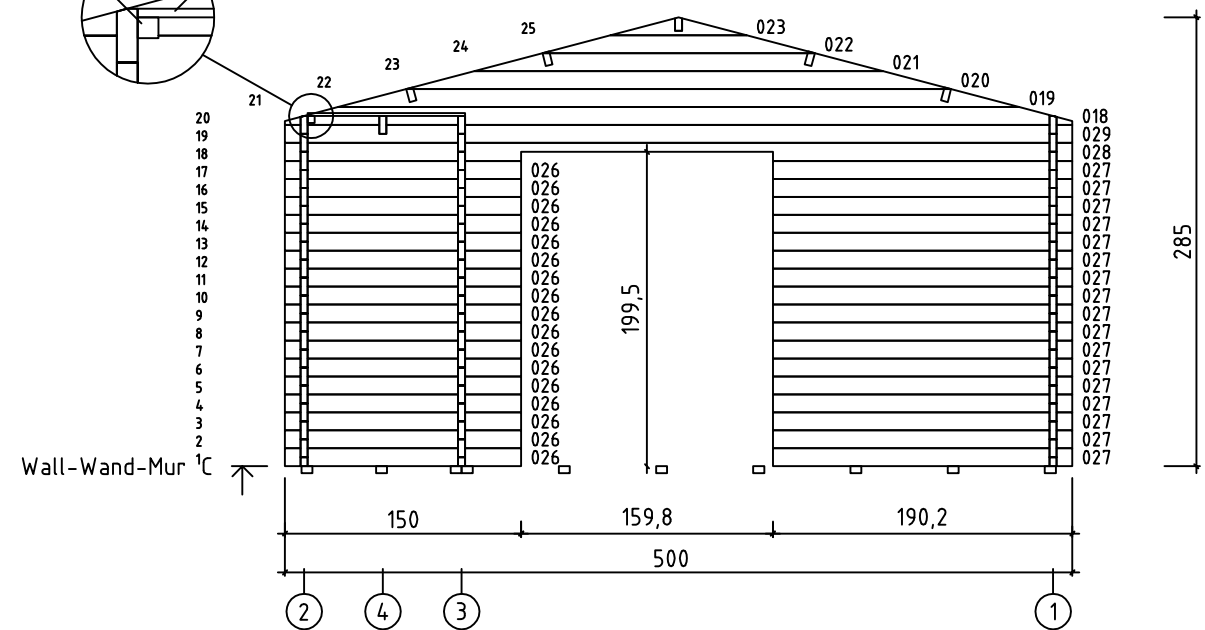
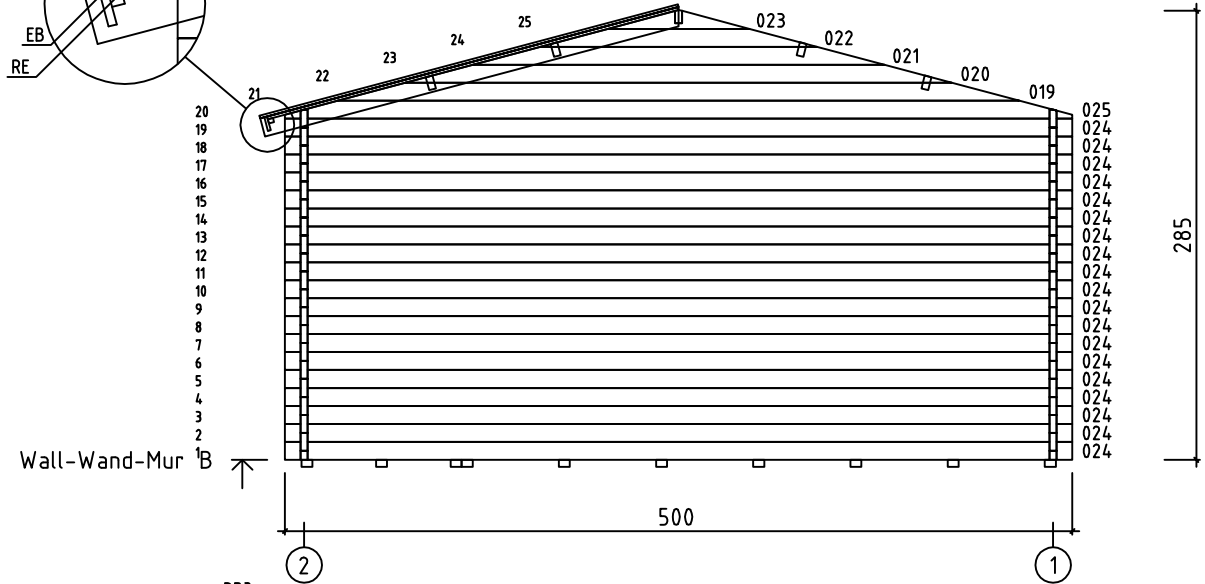
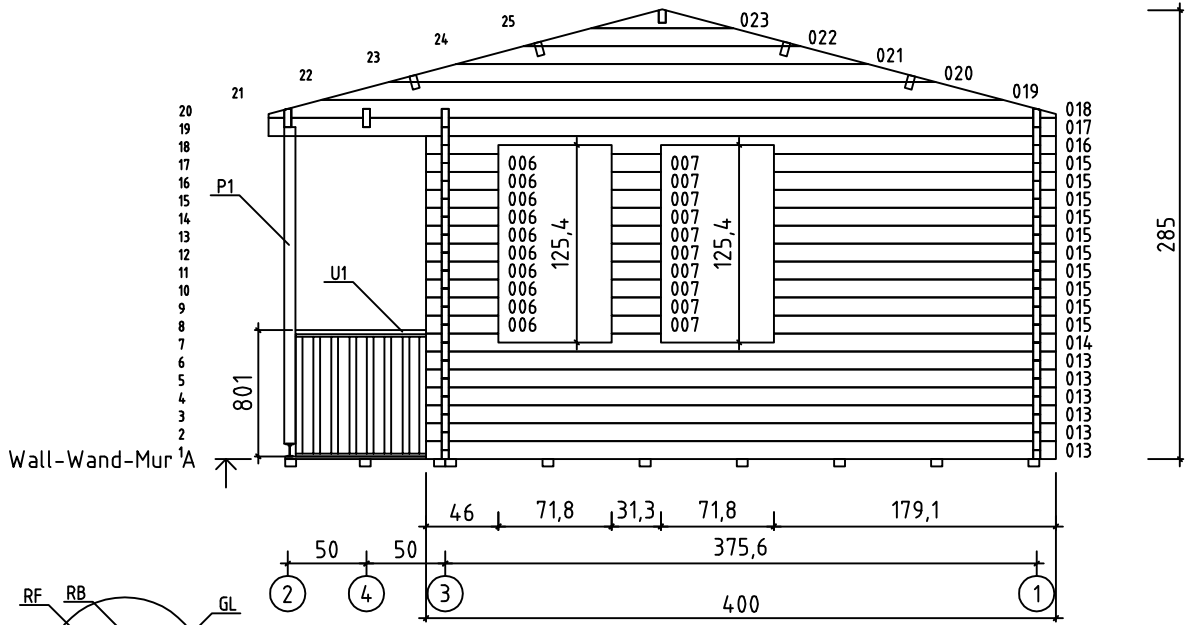

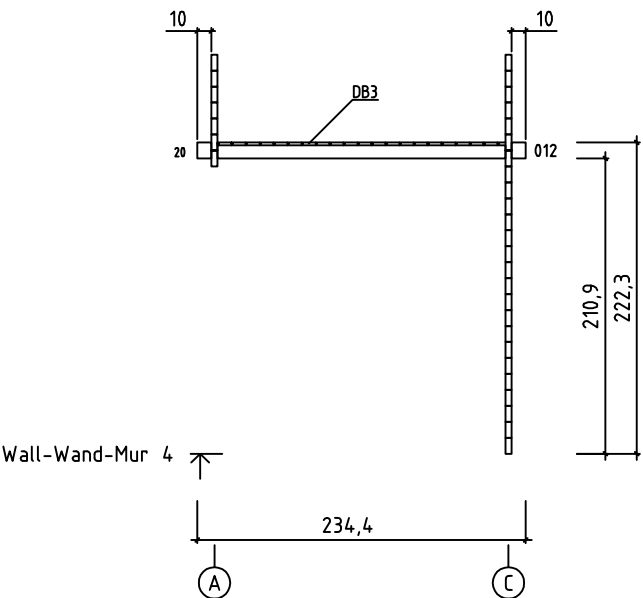
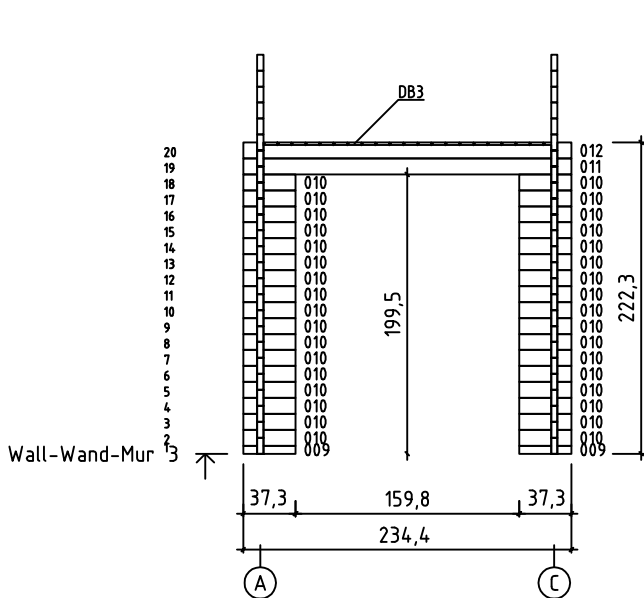
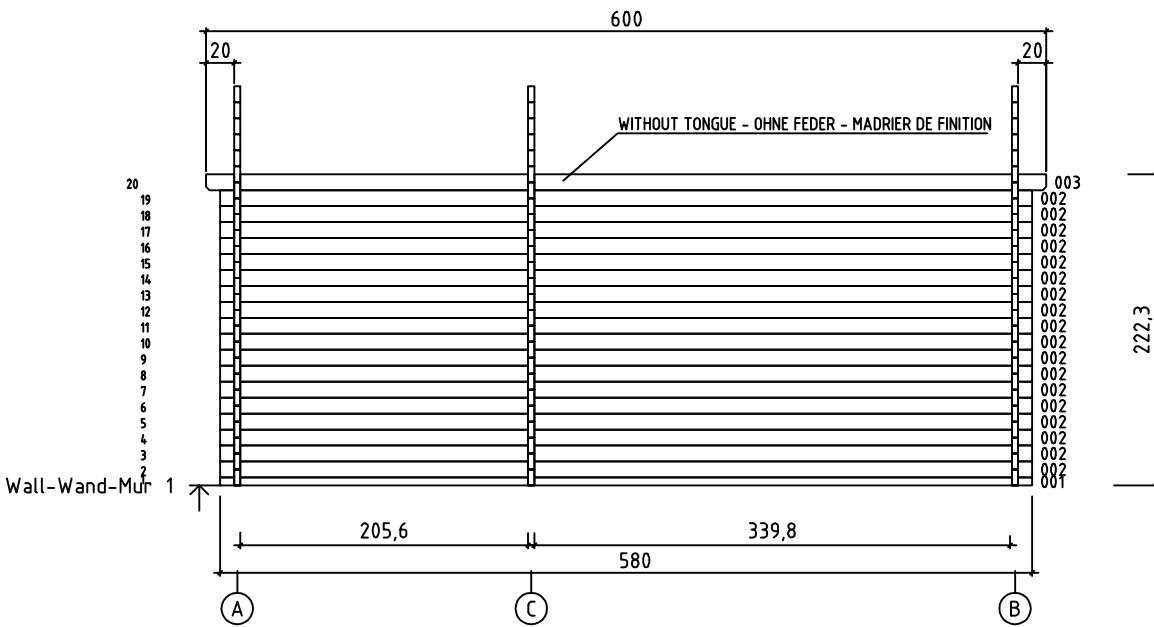
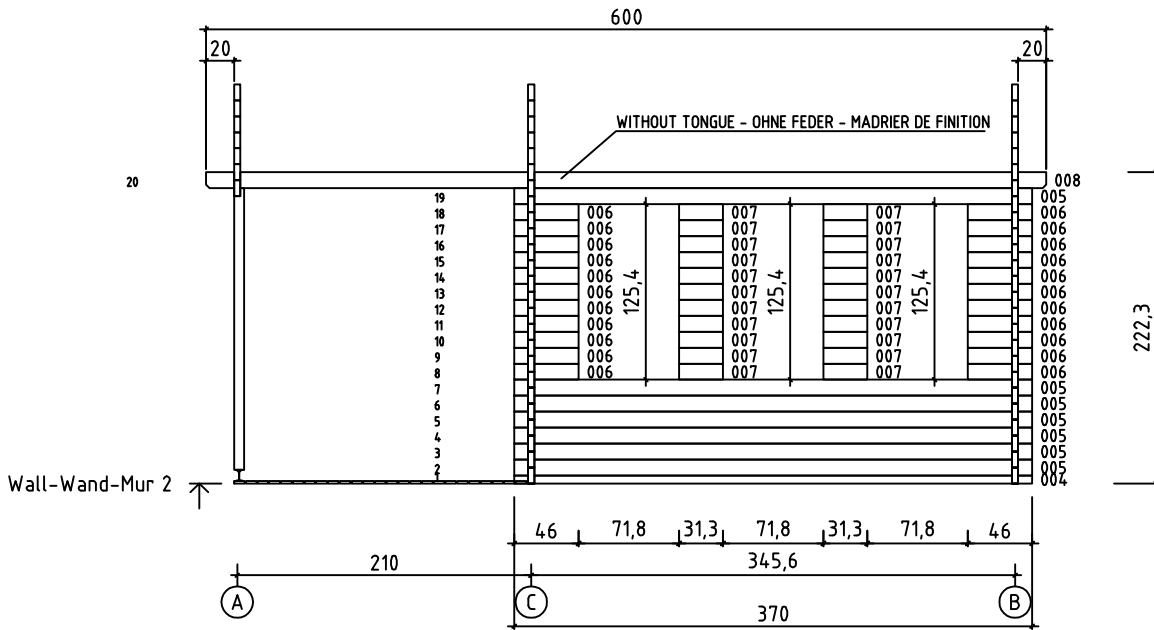

Art.Nr. 443802

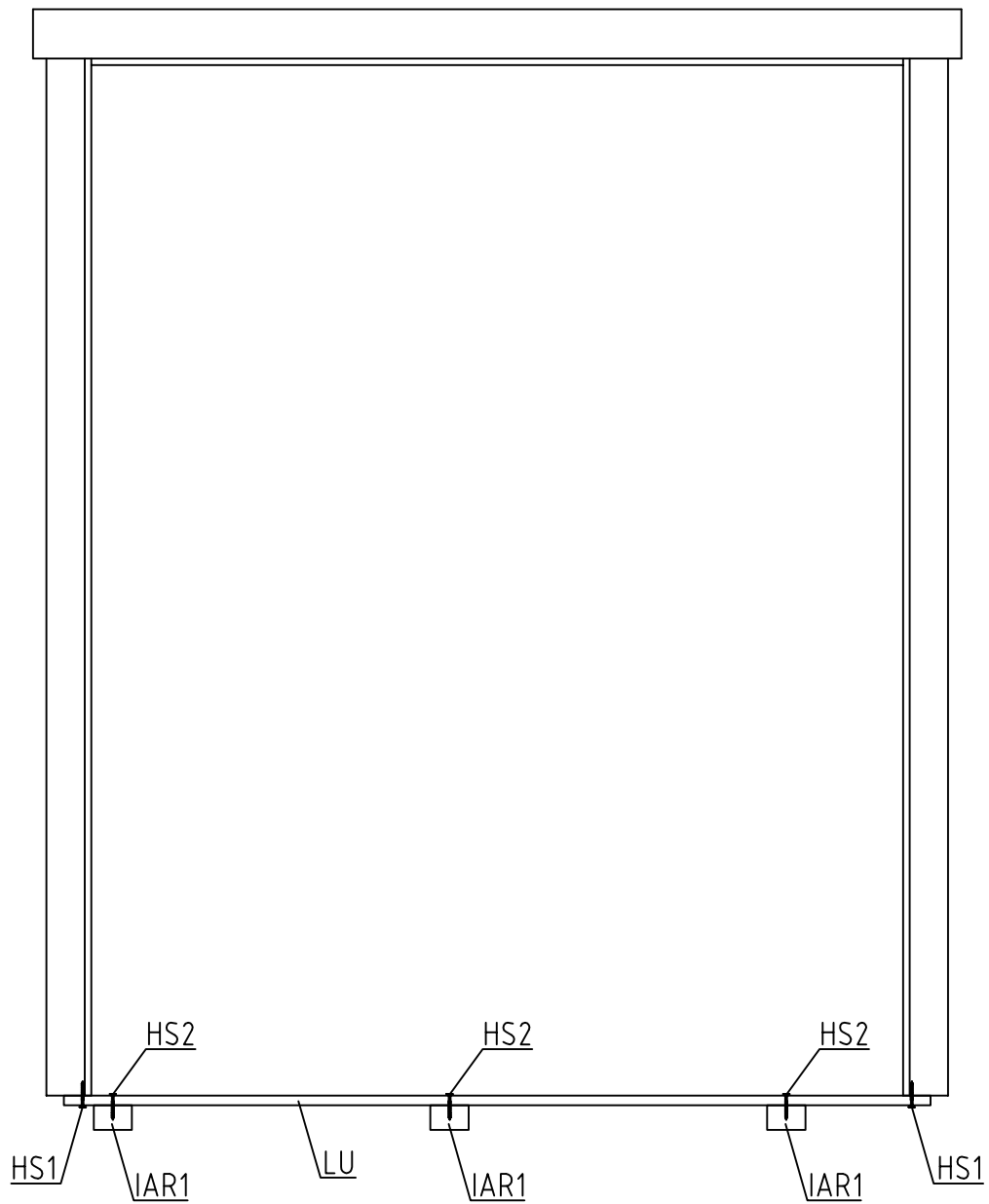

DOOR FRAME-TÜRRAHMEN-POUR MONTANT DE PORTE 1588x1957







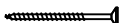

Pos	20.03.2014	Piecelist - Stücklist - Liste des composants Art.Nr. 443802	7/10	Q.	P. (mm)	L. (mm)
001				1	44x57	5800
002				18	44x114	5800
003				1	44x120	6000
004				1	44x57	3700
005				7	44x114	3700
006				32	44x114	460
007				32	44x114	313
008				1	44x120	6000
009				2	44x57	373
010				34	44x114	373
011				1	44x114	2344
012				2	44x114	2344
013				6	44x114	4000
014				1	44x114	4000
015				10	44x114	1791
016				1	44x114	4000
017				1	44x114	5000
024				19	44x114	5000
026				17	44x114	1500
027				17	44x114	1902
028				1	44x114	5000
029				1	44x114	5000
WA-1 WC-1				1 1		

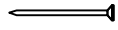
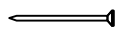
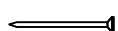
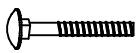
Pos	20.03.2014	Piecelist - Stücklist - Liste des composants Art.Nr. 443802	8/10	Q.	P. (mm)	L. (mm)
WB-1				1		
IAR1	FOUNDATION - FUNDAMENT - FONDATION 			10	70x45	5590
PR1	ROOF BEAM - DACHBALKEN - PANNE DE TOIT 			1	44x140	6000
PR21	ROOF BEAM - DACHBALKEN - PANNE DE TOIT 			4	44x140	6000
	FLOOR BOARDS - FUSSBODENBRETTER - LAME DE PLANCHER 			38	90x18	4708
	FLOOR BOARDS - FUSSBODENBRETTER - LAME DE PLANCHER 			23	90x18	3708
DB3	CEILING BOARDS - DECKENBRETT - VOLIGES SOUS PLAFOND 			23	90x18	1000
	TERRACE BOARDS - TERRASSENBRETTER - - PLANCHER DE TERRASSE 			21	90x19	1000
RB	ROOF BOARDS - DACHBRETTER - VOLIGES 			134	90x18	2700
	FLOOR FILLET-FUSSBODENLEISTE - CORNIERE DE FINITION DU PLANCHER 				18x18	27.75
RF	ROOFING FELT FILLET - DACHPAPPENLEISTE - BAGUETTE DE FIXATION DU FEUTRE BITUMEUX 			4	18x58	2750
LU	DOORSTEP - SWELLE - SEUIL DE PORTE			1	18x48	1588
	TERRACE RAILING - TERRASSENZAUN - - GARDE-CORPS DE TERRASSE 			1	800x44	830
P1	POST - PFOSTEN - POTEAU 			1	70x70	2070
EB	EAVES BOARD - TRAUFBRETT - BANDEAU DE TOIT 			4	18x90	3000
RE	ROOF EDGE REINFORCEMENT - DACHRANDVERSTÄRKUNG - CORNIERE DE RENFORT DE BORD DE TOIT 			4	28x34	3000
	STORM PROTECTION - STURMLEISTE - - LATTE ANTI-TEMPETE 			4	22x45	2200
U1	U-PROFILE - TERRASSENEINFASSUNG - PROFILE U 			1	35x70	830
LS	LOFT SUPPORT - DACHBEFESTIGUNG - CORNIÈRE DE RENFORT DE FIXATION DE TOITURE 			1	44x44	2055
GL	GABLE MOULDING - GIEBELLEISTE - - PLANCHE DE RIVE 			4	18x120	2750
	WINDOW HANDLE FITTINGS - FENSTERGRIFF - POIGNÉE D'OUVERTURE DE FENETRE 			10		

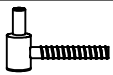
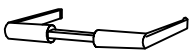

Pos	20.03.2014	Piecelist - Stücklist - Liste des composants Art.Nr. 443802	9/10	Q.	P. (mm)	L. (mm)
		BOLT FOR WINDOW HANDLE FITTINGS - BOLZEN FÜR FENSTERGRIFF BESCHLAG - BOULON POUR POIGNÉE D'OUVERTURE DE FENETRE		20		
		SCREW FOR U-PROFILE - SCHRAUBE ZUR BEFESTIGUNG U-PROFILS - VIS A TETE FRAISÉE POUR PROFIL U		4	3.5x50	
		SCREW FOR ROOF EDGE REINFORCEMENT - SCHRAUBEN FÜR DACHRANDVERSTÄRKUNG - VIS POUR RENFORT DE BORD DE TOIT		28	4x40	
HS1		SCREW FOR DOOR JAMB - SCHRAUBE FÜR TÜRRAHMEN - VIS DE FIXATION POUR MONTANT DE PORTE		2	4x40	
		SCREW FOR ROOF BEAMS - SCHRAUBEN FÜR DACHBALKEN - VIS POUR PANNE DE TOIT		21	5x120	
		SCREW FOR 1. WALL BEAM - SCHRAUBE FÜR 1. BOHLENREIHE - VIS DE FIXATION DES FONDATIONS		11	5x90	
		SCREW FOR POST HEIGHT ADJUSTMENT - SCHRAUBEN FÜR REGULIERUNGSSCHRAUBE FÜR PFOSTEN - VIS DE FIXATION DE SUPPORT RÉGLABLE DE POTEAU		8	6x50	
		SCREW FOR GEORGIAN BARS - SCHRAUBE FÜR SPROSSEN - VIS DE BARRES GEORGIENNE		46	2.5x20	
		SCREW FOR GABLE SEGMENT - SCHRAUBEN FÜR DECKBLATT - VIS POUR FIXATION LOSANGE DE FINITION		4	3.5x35	
		SCREW FOR GABLE MOULDING - SCHRAUBEN FÜR GIEBELLEISTE - VIS DE FIXATION POUR PLANCHE DE RIVE		32	3.5x50	
		SCREW FOR DOOR FILLET - SCHRAUBE ZUR BEFESTIGUNG TÜRLEISTE - VIS D'ASSEMBLAGE DU CADRE DE PORTE		5	3x30	
		SCREW FOR U-PROFILE - SCHRAUBE ZUR BEFESTIGUNG U-PROFILS - VIS A TETE FRAISÉE POUR PROFIL U		6	4.5x80	
		SCREW FOR U-PROFILE - SCHRAUBE ZUR BEFESTIGUNG U-PROFILS - VIS A TETE FRAISÉE POUR PROFIL U		6	4.5x80	
HS2		SCREW FOR DOORSTEP - SCHRAUBEN FÜR SWELLE - VIS DE FIXATION DU SEUIL DE PORTE		3	4x40	
		SCREW FOR EAVES BOARDS - SCHRAUBEN FÜR TRAUFBRETT - VIS DE FIXATION POUR BANDEAU DE TOIT		28	4x40	
		SCREW FOR POST - SCHRAUBEN FÜR PFOSTEN - VIS DE FIXATION DES POTEAUX		2	4x60	
		SCREW FOR FUNDAMENT - SCHRAUBEN ZUR BEFESTIGUNG FUNDAMENT - VIS POUR FONDATION		4	5x120	
		SCREW FOR GABLE - SCHRAUBEN FÜR GIEBEL - VIS POUR FIXATION DES PIGNONS		36	5x120	
		SCREW FOR DOOR JAMB - SCHRAUBE FÜR TÜRRAHMEN - VIS DE FIXATION POUR MONTANT DE PORTE		8	5x90	
		SCREW FOR DOORSTEP - SCHRAUBEN FÜR SWELLE - VIS DE FIXATION DU SEUIL DE PORTE		3	4.5x65	
		ZN NAIL FOR FLOOR FILLET - ZN NÄGEL FÜR FUSSBODENLEISTE - POINTE POUR CORNIERE DE FINITION DU PLANCHER		58	1.4x40	
		HAMMER BLOCK - SCHLAGHOLZ - CALLE DE FRAPPE		1		
		NUT FOR STORM PROTECTION - SCHRAUBENMUTTER FÜR STURMLEISTE - ÉCROU POUR LAME ANTI-TEMPETE		8	D8	
		NUT FOR POST HEIGHT ADJUSTMENT - SCHRAUBENMUTTER FÜR REGULIERUNGSSCHRAUBE FÜR PFOSTEN - ÉCROU DE FIXATION DE SUPPORT RÉGLABLE DE POTEAU		1	D16	
		ZN NAIL FOR TERRACE - ZN NÄGEL FÜR TERRASSENBRETT - POINTE POUR PLANCHER DE TERRASSE		126	2.1x50	

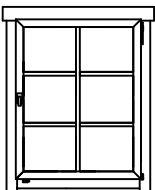
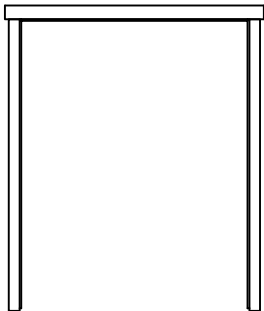
Pos	20.03.2014	Piecelist - Stücklist - Liste des composants Art.Nr. 443802	10/10	Q.	P. (mm)	L. (mm)
		ZN NAIL FOR ROOF - ZN NÄGEL FÜR DACHBRETTER - POINTES DE FIXATIONS DES VOLIGES DE TOIT		562	2x50	
		ZN NAIL FOR FLOOR - ZN NÄGEL FÜR FUSSBODENBRETTER - CLOUS POUR PLANCHER		591	2x50	
		ZN NAIL FOR ROOFING FELT FILLET - ZN NÄGEL FÜR DACHPAPPENLEISTE - POINTE POUR BAGUETTE FIXATION FEUTRE BITUMEUX		28	2x40	
		BOLT FOR STORM PROTECTION - BOLZEN FÜR STURMLEISTE - VIS POUR LAME ANTI-TEMPETE		8	8x80	
		GABLE SEGMENT - DECKBLATT - LOSANGE DE FINITION		2		
		WASHER FOR STORM PROTECTION - DICHTSCHEIBE FÜR STURMLEISTE - RONDELLE POUR LAME ANTI-TEMPETE		8	D8	
		SET OF DOOR LOCK COVERS - SCHLOSSBLENDEN - SET DE GARNITURES DE SERRURE DE PORTE		1		
		MALE BOLT HINGE FOR DOOR - TÜRRIEGEL - PARTIE MALE DE CHARNIERE DE PORTE		6	16x44/52	
		DOOR HANDLE FITTINGS - TÜRGRIF - SET DE GARNITURES DE SERRURE DE PORTE		1		
		CYLINDER LOCK - ZYLINDERSCHLOSS - CYLINDRE DE SERRURE		1	30/35	
		POST HEIGHT ADJUSTMENT - REGULIERUNGSSCHRAUBE FÜR PFOSTEN - SUPPORT RÉGLABLE DE POTEAU		1		
		WINDOW - FENSTER - FENETRE 710x1224 DGP	AK.1.106.PSP	5		
						
		DOOR FRAME-TÜRRAHMEN-POUR MONTANT DE PORTE 1588x1957		1		
						
		DOOR - TÜR - PORTE 1588x1957 DGP	TUK.1.108.PVP.MM	1		
		